



# VLR-210BR0711

**SICK**  
Sensor Intelligence.



Illustration may differ

## Ordering information

Type	Part no.
VLR-210BR0711	2118272

Other models and accessories → [www.sick.com/](http://www.sick.com/)

## Detailed technical data

### Technical specifications

<b>Accessory group</b>	Illuminations
<b>Accessory family</b>	LED
<b>Description</b>	Bar Light
<b>Ambient operating temperature</b>	0 °C ... +40 °C <sup>1)</sup>
<b>Storage temperature</b>	-20 °C ... +60 °C
<b>Light source</b>	LED, white, 5,500 K
<b>Illuminated field</b>	30 mm x 75 mm
<b>LED class</b>	Risk group 1 (low risk, IEC62471 : 2008)
<b>Trigger input signal</b>	24 V DC High = Light ON
<b>Supply voltage</b>	24 V DC
<b>Current consumption</b>	0.24 A
<b>Connections</b>	Connector M12, 4-pin, L = 0.5 m
<b>Note</b>	Not free of paint wetting impairment substances.

<sup>1)</sup> Light intensity may vary depending on the ambient temperature.

### Classifications

<b>ECLASS 5.0</b>	27110635
<b>ECLASS 5.1.4</b>	27110635
<b>ECLASS 6.0</b>	27110635
<b>ECLASS 6.2</b>	27110635
<b>ECLASS 7.0</b>	27110635
<b>ECLASS 8.0</b>	27110635
<b>ECLASS 8.1</b>	27110635
<b>ECLASS 9.0</b>	27110635
<b>ECLASS 10.0</b>	27110635
<b>ECLASS 11.0</b>	27110635
<b>ECLASS 12.0</b>	27110635
<b>ETIM 5.0</b>	EC000996
<b>ETIM 6.0</b>	EC000996
<b>ETIM 7.0</b>	EC000996
<b>ETIM 8.0</b>	EC000996
<b>UNSPSC 16.0901</b>	39101628

Dimensional drawing (Dimensions in mm (inch))

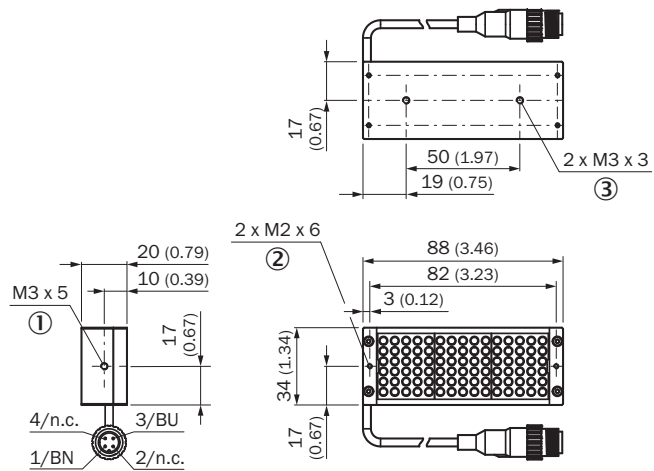

- ① On both sides for installation
- ② For optional parts
- ③ For installation

## SICK AT A GLANCE

SICK is one of the leading manufacturers of intelligent sensors and sensor solutions for industrial applications. A unique range of products and services creates the perfect basis for controlling processes securely and efficiently, protecting individuals from accidents and preventing damage to the environment.

We have extensive experience in a wide range of industries and understand their processes and requirements. With intelligent sensors, we can deliver exactly what our customers need. In application centers in Europe, Asia and North America, system solutions are tested and optimized in accordance with customer specifications. All this makes us a reliable supplier and development partner.

Comprehensive services complete our offering: SICK LifeTime Services provide support throughout the machine life cycle and ensure safety and productivity.

For us, that is “Sensor Intelligence.”

## WORLDWIDE PRESENCE:

Contacts and other locations –[www.sick.com](http://www.sick.com)