



IHM06-04NNSVW2S

IMM

INDUCTIVE PROXIMITY SENSORS

SICK
Sensor Intelligence.



Ordering information

Type	Part no.
IHM06-04NNSVW2S	1104514

Other models and accessories → www.sick.com/IMM

Illustration may differ



Detailed technical data

Features

Housing	Cylindrical smooth housing
Housing	Standard design
Diameter	Ø 6.5 mm
Sensing range S_n	4 mm
Safe sensing range S_a	3.24 mm
Installation type	Non-flush
Switching frequency	3,500 Hz
Connection type	Cable, 3-wire, 2 m
Switching output	NPN
Output function	NO
Electrical wiring	DC 3-wire
Enclosure rating	IP67 ¹⁾
Special features	Visual adjustment indicator

¹⁾ According to EN 60529.

Mechanics/electronics

Supply voltage	10 V DC ... 30 V DC
Ripple	≤ 20 % ¹⁾
Voltage drop	≤ 2 V ²⁾
Time delay before availability	≤ 80 ms
Hysteresis	1 % ... 10 %
Reproducibility	≤ 2 % ³⁾
Temperature drift (of S_n)	≤ 10 %

¹⁾ Of V_S .

²⁾ With $I_a = 200$ mA.

³⁾ Supply voltage U_B and constant ambient temperature T_a .

EMC	EN 60947-5-2
Continuous current I_a	≤ 200 mA
Cable material	PVC
Conductor size	0.25 mm ²
Cable diameter	Ø 3.7 mm
Short-circuit protection	✓
Reverse polarity protection	✓
Power-up pulse protection	✓
Shock and vibration resistance	30 g, 11 ms / 10 ... 55 Hz, 1 mm
Ambient operating temperature	-25 °C ... +70 °C
Housing material	Stainless steel V2A, DIN 1.4305 / AISI 303
Sensing face material	Plastic, LCP
Housing length	42.5 mm
UL File No.	NRKH.E348498

1) Of V_S.

2) With I_a = 200 mA.

3) Supply voltage U_B and constant ambient temperature T_a.

Safety-related parameters

MTTF_D	1,330 years
DC_{avg}	0 %
T_M (mission time)	20 years

Reduction factors

Note	The values are reference values which may vary
St37 steel (Fe)	1
Stainless steel (V2A, 304)	Approx. 0.75
Aluminum (Al)	Approx. 0.5
Copper (Cu)	Approx. 0.43
Brass (Br)	Approx. 0.54

Installation note

Remark	Associated graphic see "Installation"
A	6.5 mm
B	18 mm
C	6.5 mm
D	12 mm
E	8 mm
F	32 mm

Classifications

ECLASS 5.0	27270101
ECLASS 5.1.4	27270101
ECLASS 6.0	27270101

ECLASS 6.2	27270101
ECLASS 7.0	27270101
ECLASS 8.0	27270101
ECLASS 8.1	27270101
ECLASS 9.0	27270101
ECLASS 10.0	27270101
ECLASS 11.0	27270101
ECLASS 12.0	27274001
ETIM 5.0	EC002714
ETIM 6.0	EC002714
ETIM 7.0	EC002714
ETIM 8.0	EC002714
UNSPSC 16.0901	39122230

Adjustments

Installation aid

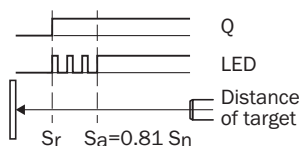

Installation note

Fixing with setscrew

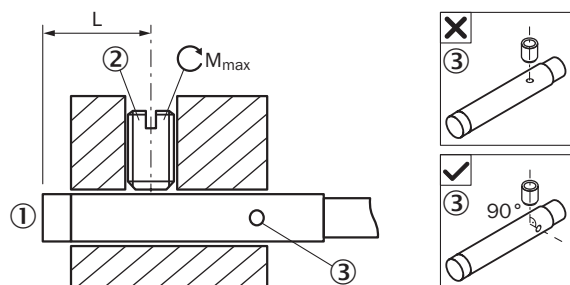

- ① Sensing face
- ② Recommended setscrew: M3, flat point
- ③ Display LED

Sensor type	Mounting area (L)	Max. tightening torque (M_{max})
IHM06-04N****K	8 mm ... 21 mm	≤ 0.4 Nm
IHM06-04N***TOK	8 mm ... 32 mm	≤ 0.4 Nm
IHM06-04N****S	8 mm ... 32 mm	≤ 0.4 Nm
IHM06-04N***TOS	8 mm ... 42 mm	≤ 0.4 Nm
IHM06-06N****K	12 mm ... 21 mm	≤ 0.4 Nm
IHM06-06N***TOK	12 mm ... 32 mm	≤ 0.4 Nm

Sensor type	Mounting area (L)	Max. tightening torque (M_{max})
IHM06-06N*****S	12 mm ... 32 mm	≤ 0.4 Nm
IHM06-06N***TOS	12 mm ... 42 mm	≤ 0.4 Nm

Mounting using BEF-KH-M06 bracket

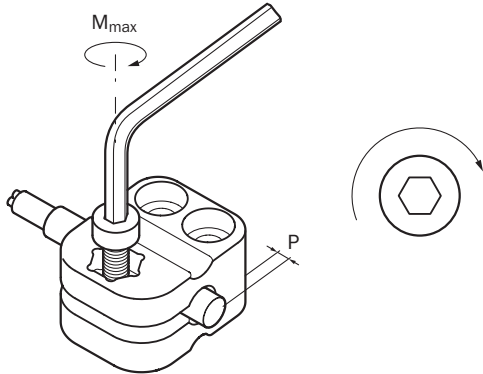

Sensor type	Mounting adapter	Overrun (P)	Max. tightening torque (M_{max})
IHM06-04N***** IHM06-06N*****	BEF-KH-M06, part no. 2101067	≥ 4 mm	≤ 0.6 Nm

Non-flush installation

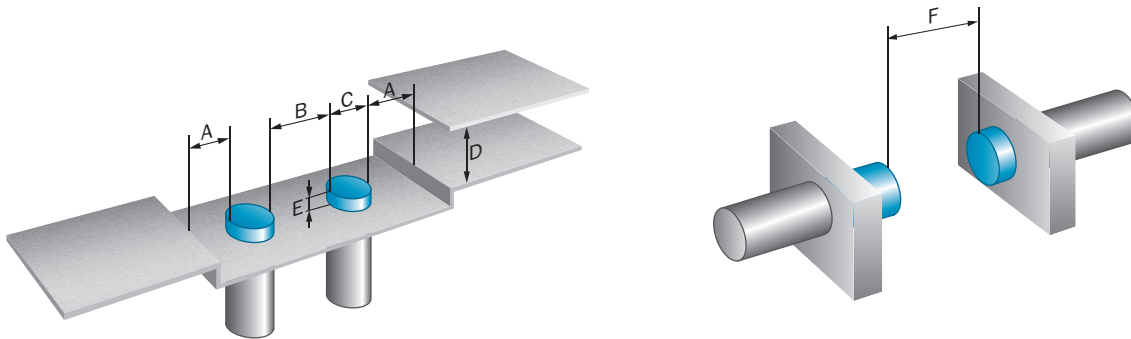

Connection diagram

Cd-001

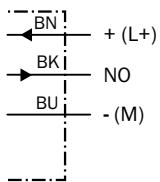

Response diagram

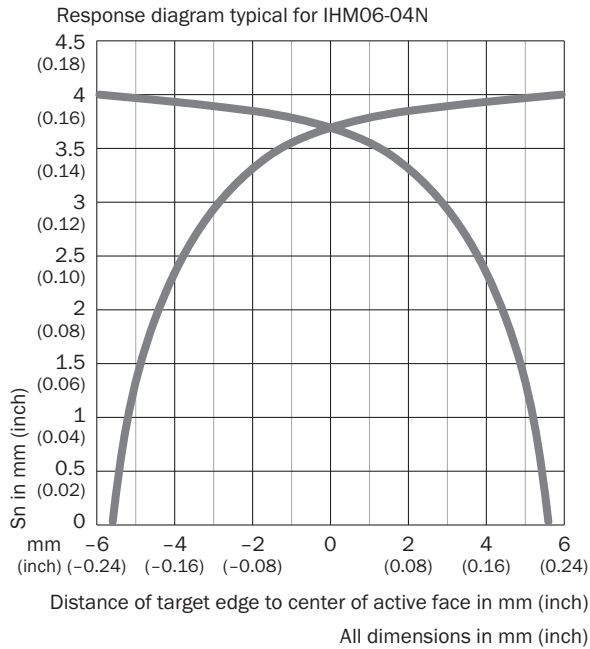

Dimensional drawing (Dimensions in mm (inch))



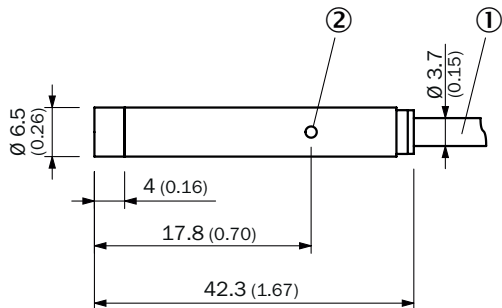



IHM06, standard variant, non-flush, cable



Recommended accessories

Other models and accessories → www.sick.com/IMM

	Brief description	Type	Part no.
Plug connectors and cables			
	<ul style="list-style-type: none"> Connection type head A: Male connector, M8, 3-pin, straight Description: Unshielded Connection systems: Screw-type terminals Permitted cross-section: 0.14 mm² ... 0.5 mm² 	STE-0803-G	6037322

	Brief description	Type	Part no.
	<ul style="list-style-type: none"> • Connection type head A: Male connector, M8, 3-pin, angled • Description: Unshielded • Connection systems: Screw-type terminals • Permitted cross-section: 0.14 mm² ... 0.5 mm² 	STE-0803-WSK	6053170
Terminal and alignment brackets			
	Plastic (PA6), without mounting hardware	BEF-KH-M06	2101067
Others			
	<ul style="list-style-type: none"> • Connection type head A: 3-pin • Slot connection type: M8, 3-pin, A-coded, female connector • Description: Unshielded • Items supplied: 5 x labeling plates 	Y8A34A2-C2A8000XXX	2115733
		Y8A36A2-C2A8000XXX	2115734
		Y8A34A2-LXXXUAA050	2115727
		Y8A36A2-LXXXUBA050	2115728

SICK AT A GLANCE

SICK is one of the leading manufacturers of intelligent sensors and sensor solutions for industrial applications. A unique range of products and services creates the perfect basis for controlling processes securely and efficiently, protecting individuals from accidents and preventing damage to the environment.

We have extensive experience in a wide range of industries and understand their processes and requirements. With intelligent sensors, we can deliver exactly what our customers need. In application centers in Europe, Asia and North America, system solutions are tested and optimized in accordance with customer specifications. All this makes us a reliable supplier and development partner.

Comprehensive services complete our offering: SICK LifeTime Services provide support throughout the machine life cycle and ensure safety and productivity.

For us, that is “Sensor Intelligence.”

WORLDWIDE PRESENCE:

Contacts and other locations –www.sick.com