

## RACCORDS FONTE MALLEABLE NOIR ET GALVA BSP TUPY

Raccord fonte malléable noir ou galvanisé pour les réseaux d'eau froide, eau chaude, incendie, Sprinkler, irrigation, chauffage, climatisation, hydrocarbures, air comprimé et vapeur.

Construction suivant la norme NF EN10242, symbole de conception A.



**Dimensions :** DN1/8" à DN4"  
**Raccordement :** BSP  
**Température Mini :** -20°C  
**Température Maxi :** +300°C  
**Pression Maxi :** 25 Bars  
**Caractéristiques :** Construction suivant norme NF EN 10242  
Symbole de conception A  
Finition noire ou galvanisée à chaud

**Matière :** Fonte EN-GJMB-350-10

\* la garantie fabrication ne couvre pas les défauts d'installation ni les défauts d'usure

Sferaco 90 rue du Ruisseau 38297 St Quentin Fallavier Tél : 04.74.94.15.90 Fax : 04.74.95.62.08 Internet : [www.sferaco.fr](http://www.sferaco.fr) E-mail : [info@sferaco.fr](mailto:info@sferaco.fr)

## RACCORDS FONTE MALLEABLE NOIR ET GALVA BSP TUPY

### CARACTERISTIQUES :

- Construction suivant la norme NF EN 10242 et ISO 49
- Symbole de conception A
- Finition noire ou galvanisée à chaud
- Compatible eau potable pour les séries galvanisées
- Filetage mâle BSP conique ISO 7-1 R
- Filetage femelle BSP cylindrique ISO 7-1 Rp
- Raccords testés à la température ambiante avec une pression de 100b

### UTILISATION :

- Eau froide, Eau chaude
- Réseau incendie, Sprinkler
- Irrigation
- Chauffage, Climatisation
- Hydrocarbures
- Air comprimé
- Vapeur 10 bars maxi
- Températures mini et maxi admissibles Ts : -20°C à + 300°C
- Pression maxi admissible Ps :
  - Du DN 1/8" au DN 3/4" : 25 bars jusqu'à 120°C, 20 bars au-delà ( voir courbe )
  - A partir du DN 1" : 20 bars jusqu'à 120°C, 16 bars au-delà ( voir courbe )

### COURBE PRESSION / TEMPERATURE ( HORS VAPEUR ) :



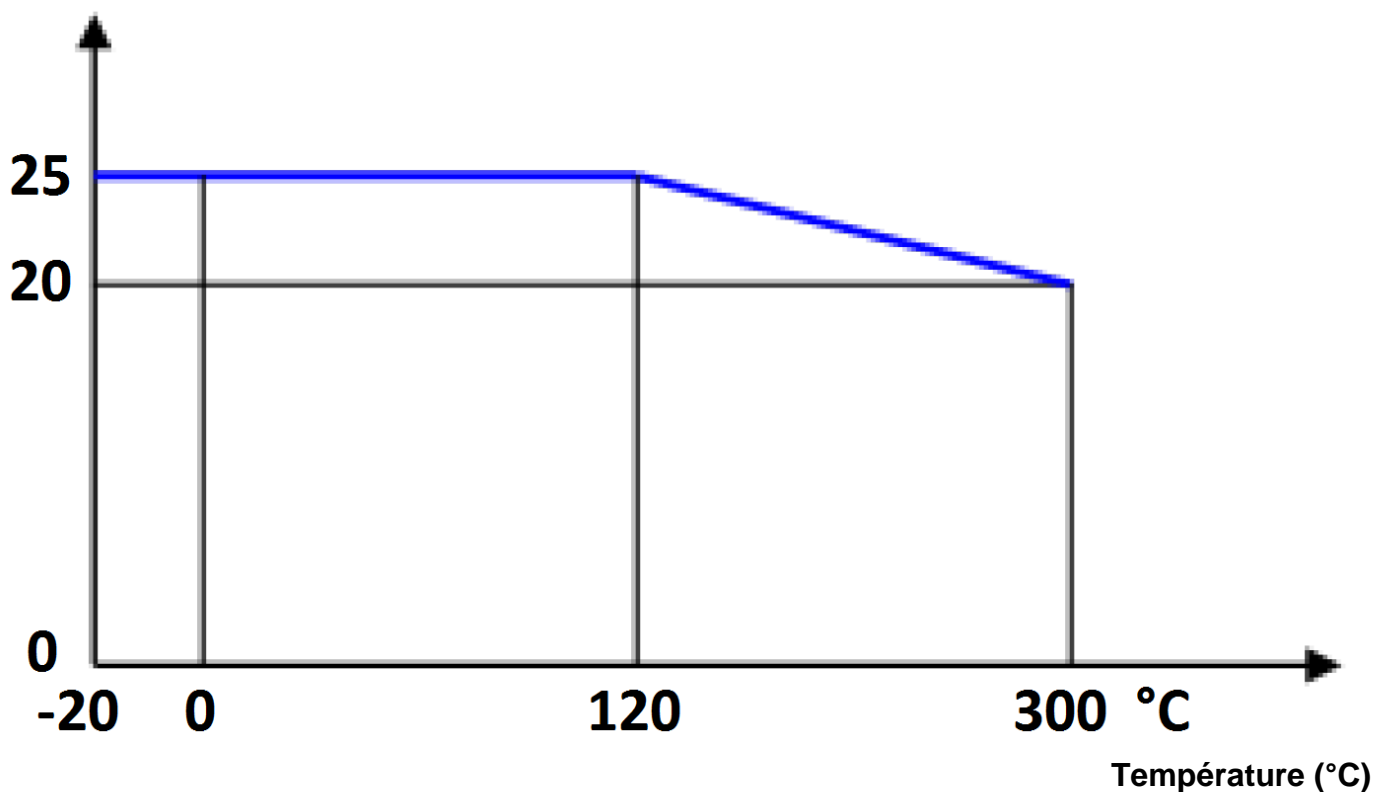

















Pression (Bar)



Un certain nombre de nos produits peuvent-être livrés en Georg Fisher. La liste exhaustive est disponible sur demande à l'adresse suivante : [info@sferaco.fr](mailto:info@sferaco.fr)  
Sferaco 90 rue du Ruisseau 38297 St Quentin Fallavier Tél : 04.74.94.15.90 Fax : 04.74.95.62.08 Internet : [www.sferaco.fr](http://www.sferaco.fr) E-mail : [info@sferaco.fr](mailto:info@sferaco.fr)

## RACCORDS FONTE MALLEABLE NOIR ET GALVA BSP TUPY







***PERTES DE CHARGE RACCORDS EGAUX (équivalent en mètre de tube acier) :***

NPS	1/4"	3/8"	1/2"	3/4"	1"	1"1/4	1"1/2	2"	2"1/2	3"	4"
DN (mm)	8x13	12x17	15x21	20x27	26x34	33x42	40x49	50x60	66x76	80x90	102x114
	0,23	0,35	0,47	0,70	0,94	1,17	1,41	1,88	2,35	2,82	3,76
	0,22	0,33	0,44	0,67	0,89	1,11	1,33	1,78	2,23	2,68	
		0,16	0,22	0,32	0,43	0,54	0,65	0,86	1,08	1,30	1,73
		0,61	0,81	1,22	1,63	2,03	2,44	3,25			
			0,27	0,41	0,55	0,68	0,82	1,04	1,37	1,64	2,18
	0,16	0,24	0,32	0,48	0,64	0,79	0,95	1,27	1,59	1,91	2,54
		0,25	0,34	0,50	0,67	0,84	1,01	1,35	1,68	2,02	2,69
	0,10	0,15	0,20	0,30	0,41	0,51	0,61	0,81	1,02	1,22	
			0,43	0,65	0,86	1,08	1,30	1,73			
	0,04	0,06	0,08	0,12	0,17	0,21	0,25	0,33	0,41	0,50	0,66
	0,34	0,51	0,69	1,03	1,37	1,71	2,06	2,74	3,43	4,11	5,49
	0,42	0,62	0,83	1,25	1,66	2,08	2,50	3,33	4,16	4,99	6,65
			0,09	0,13	0,18	0,22	0,27	0,36	0,44	0,55	0,73
			0,44	0,66	0,88	1,10	1,31	1,75	2,19	2,70	3,51
	0,05	0,08	0,10	0,15	0,20	0,25	0,30	0,41	0,49	0,59	
	0,34	0,50	0,67	1,01	1,35	1,68	2,02	2,69	3,36	4,02	
			0,28								
			0,30								
	0,01	0,01	0,01	0,01	0,01	0,01	0,01	0,01	0,01	0,01	0,02
	0,01	0,01	0,01	0,01	0,01	0,01	0,01	0,01	0,01	0,01	0,01

## RACCORDS FONTE MALLEABLE NOIR ET GALVA BSP TUPY

***PERTES DE CHARGE REDUCTIONS (équivalent en mètre de tube acier) :***

DN	3/8x1/4	1/2x1/4	1/2x3/8	3/4x1/4	3/4x3/8	3/4x1/2	1x3/8	1x1/2	1x3/4	1"1/4x1/2	1"1/4x3/4	1"1/4x1	1"1/2x1/2	1"1/2x3/4	1"1/2x1	1"1/2-1"1/4
	2x1/2	2x3/4	2 x 1	2x1"1/4	2x1"1/2	2"1/2x1	2"1/2-1"1/4	2"1/2-1"1/2	2"1/2-2"	3x1	3x1"1/4	3x1"1/2	3x2"	3x2"1/2	4x2"	4x3"

	0,05	0,06	0,07		0,09	0,10		0,11	0,14	0,13	0,14	0,17		0,15	0,17	0,21
			0,20	0,23	0,28		0,25	0,29	0,35			0,30	0,34	0,42	0,46	0,56
	0,31	0,30	0,49		0,49	0,59	0,44	0,68	0,95	0,40	0,56	0,71	0,31	0,53	0,79	1,22
	0,19	0,31	0,46	0,78	1,00	0,42	0,71	1,02	1,98	0,34	0,62	0,84	1,29	2,16		
	0,10	0,16	0,14	0,22	0,23	0,24		0,24	0,24	0,24	0,22	0,19	0,29	0,26	0,24	0,20
	0,34		0,36	0,40	0,43	0,28	0,33	0,36	0,39		0,65	0,69	0,75			
	0,24		0,45		0,45	0,59		0,49	0,84		0,50	0,55		0,65	0,73	0,86
					0,85				1,63							
	0,32	0,20	0,21		0,20	0,27		0,23	0,19		0,32	0,34			0,36	0,29
	0,11	0,18	0,18		0,26	0,32	0,30	0,32	0,29	0,33	0,43	0,16		0,53	0,27	0,12
			0,30	0,35	0,38		0,44	0,48	0,64			0,71	0,70	0,71		
	0,26	0,24	0,30		0,24	0,44		0,41	0,41	0,28	0,34	0,41		0,37	0,34	0,27
			0,52	0,60	0,64		0,51	0,65	0,89			0,64	0,77	0,86		

## RACCORDS FONTE MALLEABLE NOIR ET GALVA BSP TUPY

### DIMENSIONS (en mm):

- ART. 1 : COURBE MF GRAND RAYON 90°**

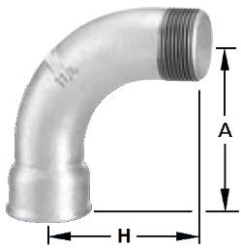

NPS	1/4"	3/8"	1/2"	3/4"	1"	1"1/4	1"1/2	2"	2"1/2	3"	4"
DN (mm)	8x13	12x17	15x21	20x27	26x34	33x42	40x49	50x60	66x76	80x90	102x114
A	40	48	55	69	85	105	116	140	176	205	260
H	36	42	48	60	75	95	105	130	165	190	245
Poids (Kg)	0.05	0.10	0.13	0.21	0.36	0.64	0.80	1.34	2.22	3.13	5.74
Ref. NOIR	1N8	1N12	1N15	1N20	1N26	1N33	1N40	1N50	1N66	1N80	1N102
Ref. GALVA	1G8	1G12	1G15	1G20	1G26	1G33	1G40	1G50	1G66	1G80	1G102

- ART. 2 : COURBE FF GRAND RAYON 90°**



NPS	3/8"	1/2"	3/4"	1"	1"1/4	1"1/2	2"	2"1/2	3"	4"
DN (mm)	12x17	15x21	20x27	26x34	33x42	40x49	50x60	66x76	80x90	102x114
A	48	55	69	85	105	116	140	176	205	260
Poids (Kg)	0.10	0.15	0.26	0.46	0.73	0.89	1.62	2.43	4.18	6.56
Ref. NOIR	2N12	2N15	2N20	2N26	2N33	2N40	2N50	2N66	2N80	2N102
Ref. GALVA	2G12	2G15	2G20	2G26	2G33	2G40	2G50	2G66	2G80	2G102

- ART. 3 : COURBE MM GRAND RAYON 90°**

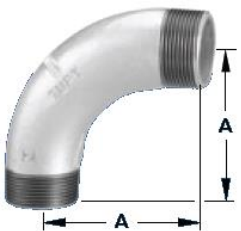

NPS	3/8"	1/2"	3/4"	1"	1"1/4	1"1/2	2"	2"1/2	3"	4"
DN (mm)	12x17	15x21	20x27	26x34	33x42	40x49	50x60	66x76	80x90	102x114
A	42	48	60	75	95	105	130	165	190	245
Poids (Kg)	0.07	0.10	0.18	0.35	0.58	0.73	1.37	2.22	3.12	5.56
Ref. NOIR	3N12	3N15	3N20	3N26	3N33	3N40	3N50	3N66	3N80	3N102
Ref. GALVA	3G12	3G15	3G20	3G26	3G33	3G40	3G50	3G66	3G80	3G102

- ART. 40 : COURBE MF GRAND RAYON 45°**

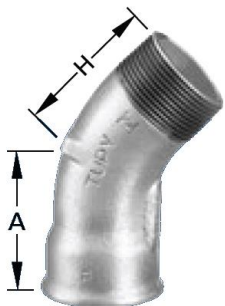

NPS	3/8"	1/2"	3/4"	1"	1"1/4	1"1/2	2"	2"1/2	3"
DN (mm)	12x17	15x21	20x27	26x34	33x42	40x49	50x60	66x76	80x90
A	30	36	43	51	64	68	81	99	113
H	24	30	36	42	54	58	70	86	100
Poids (Kg)	0.06	0.11	0.18	0.27	0.42	0.54	0.98	1.32	2.07
Ref. NOIR	40N12	40N15	40N20	40N26	40N33	40N40	40N50	40N66	40N80
Ref. GALVA	40G12	40G15	40G20	40G26	40G33	40G40	40G50	40G66	40G80

## RACCORDS FONTE MALLEABLE NOIR ET GALVA BSP TUPY

### DIMENSIONS ( en mm ) :

- **ART. 41 :** COURBE FF GRAND RAYON 45°

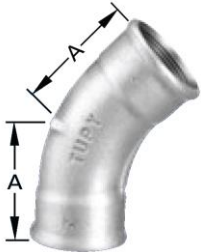

NPS	1/2"	3/4"	1"	1"1/4"	1"1/2"	2"
DN (mm)	15x21	20x27	26x34	33x42	40x49	50x60
A	36	43	51	64	68	81
Poids (Kg)	0.12	0.19	0.3	0.51	0.71	1.18
Ref. NOIR	41N15	41N20	41N26	41N33	41N40	41N50
Ref.GALVA	41G15	41G20	41G26	41G33	41G40	41G50

- **ART. 90 :** COUDE FF PETIT RAYON 90°



NPS	1/4"	3/8"	1/2"	3/4"	1"	1"1/4"	1"1/2"	2"	2"1/2"	3"	4"
DN (mm)	8x13	12x17	15x21	20x27	26x34	33x42	40x49	50x60	66x76	80x90	102x114
A	21	25	28	33	38	45	50	58	69	78	96
Poids (Kg)	0.04	0.07	0.09	0.14	0.22	0.33	0.47	0.71	1.14	1.73	2.88
Ref. NOIR	90N8	90N12	90N15	90N20	90N26	90N33	90N40	90N50	90N66	90N80	90N102
Ref.GALVA	90G8	90G12	90G15	90G20	90G26	90G33	90G40	90G50	90G66	90G80	90G102

- **ART. 90R :** COUDE REDUIT FF PETIT RAYON 90°

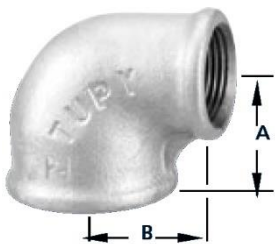

NPS	3/8"-1/4"	1/2"-1/4"	1/2"-3/8"	3/4"-3/8"	3/4"1/2"	1"-1/2"	1"-3/4"	1"1/4-3/4"	1"1/4-1"
DN (mm)	12 x 8	15 x 8	15 x 12	20 x 12	20 x 15	26 x 15	26 x 20	33 x 20	33 x 26
A	23	25	26	28	30	32	35	36	40
B	23	25	26	28	31	34	36	41	42
Poids (Kg)	0.05	0.08	0.08	0.13	0.12	0.15	0.18	0.26	0.28
Ref. NOIR	90N128	90N158	90N1512	90N2012	90N2015	90N2615	90N2620	90N3320	90N3326
Ref.GALVA	90G128	90G158	90G1512	90G2012	90G2015	90G2615	90G2620	90G3320	90G3326

NPS	1"1/4-3/4"	1"1/4-1"	1"1/2-3/4"	1"1/2-1"	1"1/2-1"1/4"	2"-1"1/2"	2"1/2-2"
DN (mm)	33 x 20	33 x 26	40 x 20	40 x 26	40 x 33	50 x 40	66 x 50
A	36	40	39	42	46	52	61
B	41	42	44	46	48	55	66
Poids (Kg)	0.26	0.28	0.31	0.37	0.43	0.62	1.01
Ref. NOIR	90N3320	90N3326	90N4020	90N4026	90N4033	90N5040	90N6650
Ref.GALVA	90G3320	90G3326	90G4020	90G4026	90G4033	90G5040	90G6650

- **ART. 92 :** COUDE MF PETIT RAYON 90°



NPS	1/4"	3/8"	1/2"	3/4"	1"	1"1/4"	1"1/2"	2"	2"1/2"	3"	4"
DN (mm)	8x13	12x17	15x21	20x27	26x34	33x42	40x49	50x60	66x76	80x90	102x114
A	21	25	28	33	38	45	50	58	69	78	96
H	28	32	37	43	52	60	65	74	88	98	118
Poids (Kg)	0.04	0.06	0.11	0.15	0.24	0.37	0.49	0.74	1.2	1.75	2.88
Ref. NOIR	92N8	92N12	92N15	92N20	92N26	92N33	92N40	92N50	92N66	92N80	92N102
Ref.GALVA	92G8	92G12	92G15	92G20	92G26	92G33	92G40	92G50	92G66	92G80	92G102



## RACCORDS FONTE MALLEABLE NOIR ET GALVA BSP TUPY

### DIMENSIONS ( en mm ) :

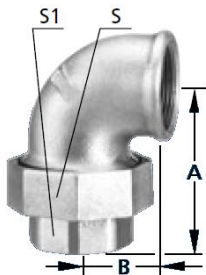

- ART. 96 :** COUDE UNION FF A JOINT CONIQUE

NPS	1/2"	3/4"	1"	1"1/4	1"1/2	2"	2"1/2	3"
DN (mm)	15x21	20x27	26x34	33x42	40x49	50x60	66x76	80x90
A	58	62	72	82	90	100	127.5	144
B	28	33	38	45	50	58	69	78
S (max)	41	50	55	70	75	90	110	130
S1	25	32	39	49	55.5	69	85	98
Poids (Kg)	0.23	0.35	0.5	0.82	1.02	1.49	2.49	3.65
Ref. NOIR	96N15	96N20	96N26	96N33	96N40	96N50	96N66	96N80
Ref.GALVA	96G15	96G20	96G26	96G33	96G40	96G50	96G66	96G80



- ART. 98 :** COUDE UNION MF A JOINT CONIQUE

NPS	1/2"	3/4"	1"	1"1/4	1"1/2	2"	2"1/2	3"
DN (mm)	15x21	20x27	26x34	33x42	40x49	50x60	66x76	80x90
A	76	82	94	107	115	128	160	179
B	28	33	38	45	50	58	69	78
S (max)	41	50	55	70	75	90	110	130
S1	25	32	39	49	55.5	69	85	98
Poids (Kg)	0.27	0.41	0.58	0.91	1.22	1.79	2.89	4.38
Ref. NOIR	98N15	98N20	98N26	98N33	98N40	98N50	98N66	98N80
Ref.GALVA	98G15	98G20	98G26	98G33	98G40	98G50	98G66	98G80



- ART. 120 :** COUDE FF PETIT RAYON 45°

NPS	3/8"	1/2"	3/4"	1"	1"1/4	1"1/2	2"	2"1/2	3"	4"
DN (mm)	12x17	15x21	20x27	26x34	33x42	40x49	50x60	66x76	80x90	102x114
A	20	22	25	28	33	36	43	50	55	66
Poids (Kg)	0.05	0.07	0.11	0.17	0.27	0.39	0.51	0.91	1.16	1.97
Ref. NOIR	120N12	120N15	120N20	120N26	120N33	120N40	120N50	120N66	120N80	120N102
Ref.GALVA	120G12	120G15	120G20	120G26	120G33	120G40	120G50	120G66	120G80	120G102

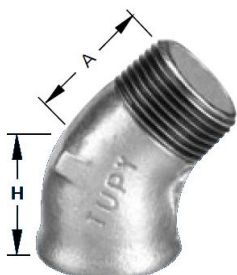

- ART. 121 :** COUDE MF PETIT RAYON 45°

NPS	3/8"	1/2"	3/4"	1"
DN (mm)	12x17	15x21	20x27	26x34
A	25	28	32	37
H	20	22	25	28
Poids (Kg)	0.04	0.07	0.1	0.16
Ref. NOIR	121N12	121N15	121N20	121N26
Ref.GALVA	121G12	121G15	121G20	121G26

## RACCORDS FONTE MALLEABLE NOIR ET GALVA BSP TUPY

### DIMENSIONS ( en mm ) :



• **ART. 130 : TE FFF EGAL**

NPS	1/4"	3/8"	1/2"	3/4"	1"	1"1/4	1"1/2	2"	2"1/2	3"	4"
DN (mm)	8x13	12x17	15x21	20x27	26x34	33x42	40x49	50x60	66x76	80x90	102x114
A	21	25	28	33	38	45	50	58	69	78	96
Poids (Kg)	0.07	0.09	0.14	0.21	0.33	0.46	0.59	0.9	1.59	2.07	4.18
Ref. NOIR	130N8	130N12	130N15	130N20	130N26	130N33	130N40	130N50	130N66	130N80	130N102
Ref. GALVA	130G8	130G12	130G15	130G20	130G26	130G33	130G40	130G50	130G66	130G80	130G102



• **ART. 130R : TE FFF CENTRE REDUIT (1=3>2)**

NPS			DN (mm)			B	A	Poids (Kg)	Ref. NOIR	Ref. GALVA
1	2	3	1	2	3					
3/8"	1/4"	3/8"	12	8	12	23	23	0.07	130N128	130G128
1/2"	1/4"	1/2"	15	8	15	24	24	0.1	130N158	130G158
1/2"	3/8"	1/2"	15	12	15	26	26	0.13	130N1512	130G1512
3/4"	3/8"	3/4"	20	12	20	28	28	0.17	130N2012	130G2012
3/4"	1/2"	3/4"	20	15	20	31	30	0.18	130N2015	130G2015
1"	3/8"	1"	26	12	26	32	30	0.2	130N2612	130G2612
1"	1/2"	1"	26	15	26	34	32	0.23	130N2615	130G2615
1"	3/4"	1"	26	20	26	36	35	0.25	130N2620	130G2620
1"1/4	1/2"	1"1/4	33	15	33	38	34	0.31	130N3315	130G3315
1"1/4	3/4"	1"1/4	33	20	33	41	36	0.33	130N3320	130G3320
1"1/4	1"	1"1/4	33	26	33	42	40	0.37	130N3326	130G3326
1"1/2	1/2"	1"1/2	40	15	40	42	36	0.39	130N4015	130G4015
1"1/2	3/4"	1"1/2	40	20	40	44	38	0.41	130N4020	130G4020
1"1/2	1"	1"1/2	40	26	40	46	42	0.45	130N4026	130G4026
1"1/2	1"1/4	1"1/2	40	33	40	48	46	0.56	130N4033	130G4033
2"	1/2"	2"	50	15	50	48	38	0.55	130N5015	130G5015
2"	3/4"	2"	50	20	50	50	40	0.59	130N5020	130G5020
2"	1"	2"	50	26	50	52	44	0.67	130N5026	130G5026
2"	1"1/4	2"	50	33	50	54	48	0.73	130N5033	130G5033
2"	1"1/2	2"	50	40	50	55	52	0.79	130N5040	130G5040
2"1/2	1"	2"1/2	66	26	66	60	47	0.93	130N6626	130G6626
2"1/2	1"1/4	2"1/2	66	33	66	62	52	1.18	130N6633	130G6633
2"1/2	1"1/2	2"1/2	66	40	66	63	55	1.26	130N6640	130G6640
2"1/2	2"	2"1/2	66	50	66	66	61	1.47	130N6650	130G6650
3"	1"	3"	80	26	80	67	51	1.28	130N8026	130G8026
3"	1"1/4	3"	80	33	80	70	55	1.23	130N8033	130G8033
3"	1"1/2	3"	80	40	80	71	58	1.51	130N8040	130G8040
3"	2"	3"	80	50	80	73	64	1.72	130N8050	130G8050
3"	2"1/2	3"	80	66	80	76	72	1.93	130N8066	130G8066



## RACCORDS FONTE MALLEABLE NOIR ET GALVA BSP TUPY

### DIMENSIONS ( en mm ) :



- **ART. 130R : TE FFF CENTRE REDUIT (1=3>2)**

NPS			DN (mm)			B	A	Poids (Kg)	Ref. NOIR	Ref. GALVA
1	2	3	1	2	3					
4"	2"	4"	102	50	102	86	70	2.35	130N10250	130G10250
4"	2 1/2"	4"	102	66	102	90	78	2.69	130N10266	130G10266
4"	3"	4"	102	80	102	92	84	3.31	130N10280	130G10280

- **ART. 130R : TE FFF CENTRE AUGMENTE (1=3<2)**

NPS			DN (mm)			B	A	Poids (Kg)	Ref. NOIR	Ref. GALVA
1	2	3	1	2	3					
3/4"	1"	3/4"	20	26	20	35	36	0.27	130N202620	130G202620

- **ART. 130R : TE FFF SORTIE REDUITE (1=2>3)**

NPS			DN (mm)			B	C	A	Poids (Kg)	Ref. NOIR	Ref. GALVA
1	2	3	1	2	3						
1 1/4"	1 1/4"	1"	33	33	26	42	34	36	0.42	130N333326	130G333326

- **ART. 130R : TE FFF ENTREE AUGMENTEE (1>2=3)**

NPS			DN (mm)			B	C	A	Poids (Kg)	Ref. NOIR	Ref. GALVA
1	2	3	1	2	3						
3/4"	1/2"	1/2"	20	15	15	31	28	30	0.18	130N201515	130G201515
1 1/4"	1"	1"	33	26	26	42	38	40	0.32	130N332626	130G332626

- **ART. 130R : TE FFF REDUIT (1≠2≠3)**

NPS			DN (mm)			B	C	A	Poids (Kg)	Ref. NOIR	Ref. GALVA
1	2	3	1	2	3						
1 1/4"	1/2"	1"	33	15	26	38	32	34	0.28	130N331526	130G331526
1 1/2"	1/2"	1 1/4"	40	15	33	42	34	36	0.38	130N401533	130G401533
1 1/2"	1"	1 1/4"	40	26	33	46	40	42	0.46	130N402633	130G402633
2"	1"	1 1/2"	50	26	40	52	42	44	0.54	130N502640	130G502640

- **ART. 132 : TE FFF EGAL 2 VOIES COURBEES**

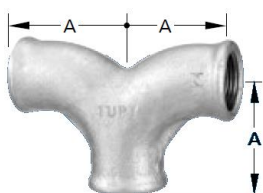

NPS	1/2"	3/4"
DN (mm)	15x21	20x27
A	45	50
Poids (Kg)	0.19	0.29
Ref. NOIR	132N15	132N20
Ref. GALVA	132G15	132G20

## RACCORDS FONTE MALLEABLE NOIR ET GALVA BSP TUPY

### DIMENSIONS ( en mm ) :

- **ART. 165 :** TE FFF EGAL OBLIQUE 45°



NPS	1/2"	3/4"	1"	1"1/4"	1"1/2"	2"	2"1/2"	3"	4"
DN (mm)	15x21	20x27	26x34	33x42	40x49	50x60	66x76	80x90	102x114
A	59	70	83	100	111	131	161	184	228
B	43	52	61	74	83	100	123	145	182
Poids (Kg)	0.15	0.24	0.40	0.59	0.78	1.29	1.78	2.90	5.02
Ref. NOIR	165N15	165N20	165N26	165N33	165N40	165N50	165N66	165N80	165N102
Ref.GALVA	165G15	165G20	165G26	165G33	165G40	165G50	165G66	165G80	165G102

- **ART. 180 :** CROIX FFFF EGALE



NPS	1/4"	3/8"	1/2"	3/4"	1"	1"1/4"	1"1/2"	2"	2"1/2"	3"	4"
DN (mm)	8x13	12x17	15x21	20x27	26x34	33x42	40x49	50x60	66x76	80x90	102x114
A	21	25	28	33	38	45	50	58	69	78	97
Poids (Kg)	0.08	0.11	0.17	0.24	0.39	0.62	0.8	1.14	1.97	2.7	4.98
Ref. NOIR	180N8	180N12	180N15	180N20	180N26	180N33	180N40	180N50	180N66	180N80	180N102
Ref.GALVA	180G8	180G12	180G15	180G20	180G26	180G33	180G40	180G50	180G66	180G80	180G102

- **ART. 221 :** DISTRIBUTEUR A COUDES 3 VOIES EGAL

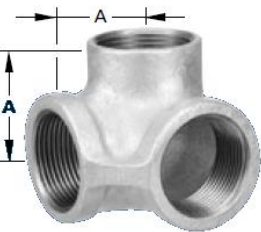

NPS	1/2"	3/4"	1"	1"1/4"	1"1/2"	2"
DN (mm)	15x21	20x27	26x34	33x42	40x49	50x60
A	28	33	38	45	50	58
Poids (Kg)	0.14	0.21	0.33	0.53	0.69	1.07
Ref. NOIR	221N15	221N20	221N26	221N33	221N40	221N50
Ref.GALVA	221G15	221G20	221G26	221G33	221G40	221G50

- **ART. 240 :** MANCHON FF REDUIT



NPS	3/8"-1/4"	1/2"-1/4"	1/2"-3/8"	3/4"-3/8"	3/4"1/2"	1"-3/8"	1"-1/2"	1"-3/4"	1"1/4-1/2"
DN (mm)	12 x 8	15 x 8	15 x 12	20 x 12	20 x 15	26 x 12	26 x 15	26 x 20	33 x 15
A	30	36	36	39	39	45	45	45	50
Poids (Kg)	0.04	0.06	0.06	0.1	0.1	0.13	0.12	0.14	0.21
Ref. NOIR	240N128	240N158	240N1512	240N2012	240N2015	240N2612	240N2615	240N2620	240N3315
Ref.GALVA	240G128	240G158	240G1512	240G2012	240G2015	240G2612	240G2615	240G2620	240G3315

NPS	1"1/4-3/4"	1"1/4-1"	1"1/2-3/4"	1"1/2-1"	1"1/2-1"1/4"	2"-1"	2"-1"1/4"
DN (mm)	33 x 20	33 x 26	40 x 20	40 x 26	40 x 33	50 x 26	50 x 33
A	50	50	55	55	55	65	65
Poids (Kg)	0.21	0.23	0.28	0.26	0.26	0.37	0.4
Ref. NOIR	240N3320	240N3326	240N4020	240N4026	240N4033	240N5026	240N5033
Ref.GALVA	240G3320	240G3326	240G4020	240G4026	240G4033	240G5026	240G5033

## RACCORDS FONTE MALLEABLE NOIR ET GALVA BSP TUPY

### DIMENSIONS ( en mm ) :

- ART. 240 :** MANCHON FF REDUIT

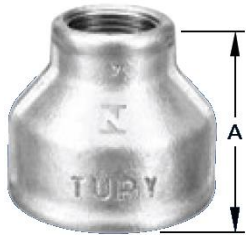

NPS	2"-1"1/2"	2"1/2-1"1/4"	2"1/2-1"1/2"	2"1/2-2"	3"-1"1/2"	3"-2"	3"-2"1/2"
DN (mm)	50 x 40	66 x 33	66 x 40	66 x 50	80 x 40	80 x 50	80 x 66
A	65	74	74	74	80	80	80
Poids (Kg)	0.41	0.6	0.58	0.62	0.8	0.91	0.87
Ref. NOIR	240N5040	240N6633	240N6640	240N6650	240N8040	240N8050	240N8066
Ref.GALVA	240G5040	240G6633	240G6640	240G6650	240G8040	240G8050	240G8066

NPS	4"-2"	4"-2"1/2"	4"-3"
DN (mm)	102 x 50	102 x 66	102 x 80
A	94	94	94
Poids (Kg)	1.54	1.6	1.69
Ref. NOIR	240N10250	240N10266	240N10280
Ref.GALVA	240G10250	240G10266	240G10280

- ART. 241 :** REDUCTION MF

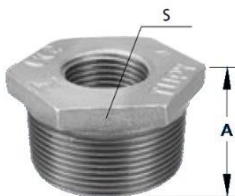

NPS	3/8"-1/4"	1/2"-1/4"	1/2"-3/8"	3/4"-1/4"	3/4"-3/8"	3/4"-1/2"	1"-3/8"	1"-1/2"	1"-3/4"
DN (mm)	12 x 8	15 x 8	15 x 12	20 x 8	20 x 12	20 x 15	26 x 12	26 x 15	26 x 20
A	20	24	24	26	26	26	29	29	29
S (max)	19	22	22	30	30	30	36	36	36
Poids (Kg)	0.02	0.04	0.03	0.07	0.06	0.05	0.11	0.1	0.09
Ref. NOIR	241N128	241N158	241N1512	241N208	241N2012	241N2015	241N2612	241N2615	241N2620
Ref.GALVA	241G128	241G158	241G1512	241G208	241G2012	241G2015	241G2612	241G2615	241G2620

NPS	1"1/4-1/2"	1"1/4-3/4"	1"1/4-1"	1"1/2-1/2"	1"1/2-3/4"	1"1/2-1"	1"1/2-1"1/4"
DN (mm)	33 x 15	33 x 20	33 x 26	40 x 15	40 x 20	40 x 26	40 x 33
A	31	31	31	31	31	31	31
S (max)	46	46	46	50	50	50	50
Poids (Kg)	0.2	0.18	0.15	0.26	0.24	0.2	0.12
Ref. NOIR	241N3315	241N3320	241N3326	241N4015	241N4020	241N4026	241N4033
Ref.GALVA	241G3315	241G3320	241G3326	241G4015	241G4020	241G4026	241G4033

NPS	2"-1/2"	2"-3/4"	2"-1"	2"-1"1/4"	2"-1"1/2"	2"1/2-1"	2"1/2-1"1/4"
DN (mm)	50 x 15	50 x 20	50 x 26	50 x 33	50 x 40	66 x 25	66 x 33
A	35	35	35	35	35	40	40
S (max)	65	65	65	65	65	80	80
Poids (Kg)	0.41	0.41	0.42	0.35	0.29	0.62	0.64
Ref. NOIR	241N5015	241N5020	241N5026	241N5033	241N5040	241N6625	241N6633
Ref.GALVA	241G5015	241G5020	241G5026	241G5033	241G5040	241G6625	241G6633

## RACCORDS FONTE MALLEABLE NOIR ET GALVA BSP TUPY

### DIMENSIONS ( en mm ) :

• **ART. 241 : REDUCTION MF**

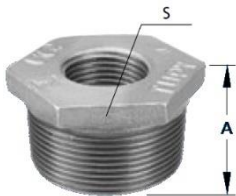

NPS	2"1/2-1"1/2	2"1/2-2"	3"-1"1/2	3"-2"	3"-2"1/2	4"-2"	4"-2"1/2	4"-3"
DN (mm)	66 x 40	66 x 50	80 x 40	80 x 50	80 x 66	102 x 50	102 x 66	102 x 80
A	40	40	44	44	44	51	51	51
S (max)	80	80	95	95	95	120	120	120
Poids (Kg)	0.6	0.5	0.92	0.97	0.64	1.71	1.75	1.48
Ref. NOIR	241N6640	244N6650	241N8040	241N8050	241N8066	241N10250	241N10266	241N10280
Ref.GALVA	241G6640	244G6650	241G8040	241G8050	241G8066	241G10250	241G10266	241G10280

• **ART. 245 : MAMELON MM REDUIT**

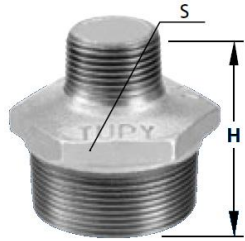

NPS	3/8"-1/4"	1/2"-1/4"	1/2"-3/8"	3/4"-3/8"	3/4"-1/2"	1"-1/2"	1"-3/4"	1"1/4-3/4"	1"1/4-1"
DN (mm)	12 x 8	15 x 8	15 x 12	20 x 12	20 x 15	26 x 15	26 x 20	33 x 20	33 x 26
H	38	44	44	47	47	56	53	57	57
S (max)	19	22	22	30	30	36	36	46	46
Poids (Kg)	0.03	0.05	0.05	0.08	0.09	0.14	0.15	0.19	0.21
Ref. NOIR	245N128	245N158	245N1512	245N2012	245N2015	245N2615	245N2620	245N3320	245N3326
Ref.GALVA	245G128	245G158	245G1512	245G2012	245G2015	245G2615	245G2620	245G3320	245G3326

NPS	1"1/2-3/4"	1"1/2-1"	1"1/2-1"1/4	2"-1"	2"-1"1/4	2"-1"1/2	2"1/2-2"
DN (mm)	40 x 20	40 x 26	40 x 33	50 x 26	50 x 33	50 x 40	66 x 50
H	59	59	59	68	68	68	75
S (max)	50	50	50	65	65	65	80
Poids (Kg)	0.22	0.25	0.26	0.43	0.37	0.42	0.66
Ref. NOIR	245N4020	245N4026	245N4033	245N5026	245N5033	245N5040	245N6650
Ref.GALVA	245G4020	245G4026	245G4033	245G5026	245G5033	245G5040	245G6650

NPS	3"-2"	3"-2"1/2
DN (mm)	80 x 50	80 x 66
H	83	83
S (max)	95	95
Poids (Kg)	0.91	0.92
Ref. NOIR	245N8050	245N8066
Ref.GALVA	245G8050	245G8066

## RACCORDS FONTE MALLEABLE NOIR ET GALVA BSP TUPY

### DIMENSIONS ( en mm ) :

- ART. 246 : REDUCTION FM**



NPS	3/8"-1/4"	1/2"-1/4"	1/2"-3/8"	3/4"-3/8"	3/4"1/2"	1"-1/2"	1"-3/4"	1"1/4-3/4"
DN (mm)	12 x 8	15 x 8	15 x 12	20 x 12	20 x 15	26 x 15	26 x 20	33 x 20
A	35	43	43	48	48	55	55	60
Poids (Kg)	0.04	0.06	0.06	0.09	0.09	0.14	0.15	0.22
Ref. NOIR	246N128	246N158	246N1512	246N2012	246N2015	246N2615	246N2620	246N3320
Ref.GALVA	246G128	246G158	246G1512	246G2012	246G2015	246G2615	246G2620	246G3320

NPS	1"1/4-1"	1"1/2-1"	1"1/2-1"1/4	2"-1"	2"-1"1/4	2"-1"1/2
DN (mm)	33 x 26	40 x 26	40 x 33	50 x 26	50 x 33	50 x 40
A	60	63	63	70	70	70
Poids (Kg)	0.22	0.29	0.27	0.37	0.39	0.41
Ref. NOIR	246N3326	246N4026	246N4033	246N5026	246N5033	246N5040
Ref.GALVA	246G3326	246G4026	246G4033	246G5026	246G5033	246G5040

- ART. 270 : MANCHON EGAL FF**



NPS	1/4"	3/8"	1/2"	3/4"	1"	1"1/4	1"1/2	2"	2"1/2
DN (mm)	8x13	12x17	15x21	20x27	26x34	33x42	40x49	50x60	66x76
A	27	30	36	39	45	50	55	65	74
Poids (Kg)	0.03	0.04	0.06	0.1	0.16	0.23	0.29	0.43	0.71
Ref. NOIR	270N8	270N12	270N15	270N20	270N26	270N33	270N40	270N50	270N66
Ref.GALVA	270G8	270G12	270G15	270G20	270G26	270G33	270G40	270G50	270G66

NPS	3"	4"
DN (mm)	80x90	102x114
A	80	94
Poids (Kg)	1.11	1.67
Ref. NOIR	270N80	270N102
Ref.GALVA	270G80	270G102

- ART. 271 : MANCHON EGAL FF FILETAGE DROITE/GAUCHE**



NPS	3/8"	1/2"	3/4"	1"	1"1/4	1"1/2	2"
DN (mm)	12x17	15x21	20x27	26x34	33x42	40x49	50x60
A	30	36	39	45	50	55	65
Poids (Kg)	0.04	0.06	0.11	0.17	0.23	0.29	0.43
Ref. NOIR	271N12	271N15	271N20	271N26	271N33	271N40	271N50
Ref.GALVA	271G12	271G15	271G20	271G26	271G33	271G40	271G50

## RACCORDS FONTE MALLEABLE NOIR ET GALVA BSP TUPY

### DIMENSIONS ( en mm ) :

- ART. 280 : MAMELON DOUBLE EGAL MM**

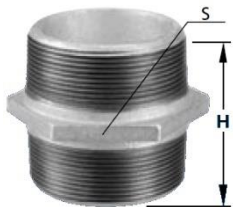

NPS	1/4"	3/8"	1/2"	3/4"	1"	1"1/4	1"1/2	2"	2"1/2	3"	4"
DN (mm)	8x13	12x17	15x21	20x27	26x34	33x42	40x49	50x60	66x76	80x90	102x114
H	36	38	44	47	53	57	59	68	75	83	95
S (max)	19	22	27	32	41	50	55	70	85	100	130
Poids (Kg)	0.03	0.04	0.07	0.11	0.18	0.26	0.33	0.59	0.95	0.95	1.89
Ref. NOIR	280N8	280N12	280N15	280N20	280N26	280N33	280N40	280N50	280N66	280N80	280N102
Ref.GALVA	280G8	280G12	280G15	280G20	280G26	280G33	280G40	280G50	280G66	280G80	280G102

- ART. 290 : BOUCHON MALE A COLLET TETE A 4 PANS**

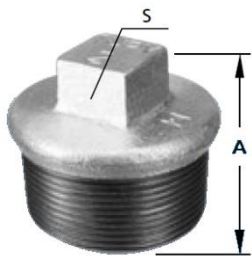

NPS	1/4"	3/8"	1/2"	3/4"	1"	1"1/4	1"1/2	2"	2"1/2	3"	4"
DN (mm)	8x13	12x17	15x21	20x27	26x34	33x42	40x49	50x60	66x76	80x90	102x114
A	27.5	28	33.5	36.5	41.5	46	48	56	63	68	
S (max)	8	10	11	17	19	22	22	27	32	36	
Poids (Kg)	0.02	0.04	0.05	0.09	0.15	0.21	0.26	0.43	0.71	1.06	
Ref. NOIR	290N8	290N12	290N15	290N20	290N26	290N33	290N40	290N50	290N66	290N80	290N102
Ref.GALVA	290G8	290G12	290G15	290G20	290G26	290G33	290G40	290G50	290G66	290G80	290G102

- ART. 291 : BOUCHON MALE SANS COLLET TETE A 4 PANS**

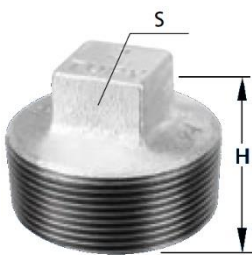

NPS	1/4"	3/8"	1/2"	3/4"	1"	1"1/4	1"1/2	2"	2"1/2	3"	4"
DN (mm)	8x13	12x17	15x21	20x27	26x34	33x42	40x49	50x60	66x76	80x90	102x114
H	20	20	24	27	30	35	36	45	51	57	71
S (max)	8	10	11	17	19	22	22	27	32	36	41
Poids (Kg)	0.01	0.02	0.04	0.05	0.08	0.14	0.16	0.3	0.52	0.77	1.53
Ref. NOIR	291N8	291N12	291N15	291N20	291N26	291N33	291N40	291N50	291N66	291N80	291N102
Ref.GALVA	291G8	291G12	291G15	291G20	291G26	291G33	291G40	291G50	291G66	291G80	291G102

- ART. 300 : BOUCHON FEMELLE HEXAGONAL**

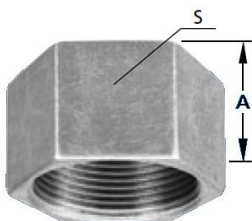

NPS	1/2"	3/4"	1"	1"1/4	1"1/2	2"	2"1/2	3"	4"
DN (mm)	15x21	20x27	26x34	33x42	40x49	50x60	66x76	80x90	102x114
A	23	25.5	29	31	31	38	42	46	56
S	26	32	39	48	54	66	84	96	123
Poids (Kg)	0.06	0.09	0.15	0.22	0.26	0.42	0.77	1.03	1.59
Ref. NOIR	300N15	300N20	300N26	300N33	300N40	300N50	300N66	300N80	300N102
Ref.GALVA	300G15	300G20	300G26	300G33	300G40	300G50	300G66	300G80	300G102



## RACCORDS FONTE MALLEABLE NOIR ET GALVA BSP TUPY

### DIMENSIONS ( en mm ) :

- ART. 312 : CONTRE ECROU EVIDE HEXAGONAL**



NPS	3/8"	1/2"	3/4"	1"	1"1/4	1"1/2	2"	2"1/2	3"
DN (mm)	12x17	15x21	20x27	26x34	33x42	40x49	50x60	66x76	80x90
A	8	9	10	11	12	13	14	17	20
S (max)	27	32	36	46	55	60	75	95	105
Poids (Kg)	0.02	0.03	0.04	0.07	0.1	0.11	0.17	0.35	0.41
Ref. NOIR	312N12	312N15	312N20	312N26	312N33	312N40	312N50	312N66	312N80
Ref.GALVA	312G12	312G15	312G20	312G26	312G33	312G40	312G50	312G66	312G80

- ART. 330 : UNION FF A JOINT PLAT**

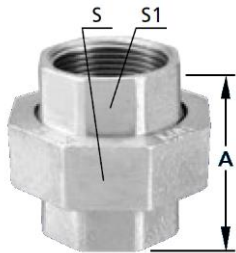

NPS	1/4"	3/8"	1/2"	3/4"	1"	1"1/4	1"1/2	2"	2"1/2	3"	4"
DN (mm)	8x13	12x17	15x21	20x27	26x34	33x42	40x49	50x60	66x76	80x90	102x114
A	42	45	48	52	58	65	70	78	85	95	110
S (max)	27	32	41	50	55	70	75	90	110	130	150
S1	17	20	25	32	39	49	55	69	85	98	124
Poids (Kg)	0.1	0.09	0.18	0.29	0.38	0.6	0.7	1.1	1.75	2.55	3.33
Ref. NOIR	330N8	330N12	330N15	330N20	330N26	330N33	330N40	330N50	330N66	330N80	330N102
Ref.GALVA	330G8	330G12	330G15	330G20	330G26	330G33	330G40	330G50	330G66	330G80	330G102

- ART. 331 : UNION EGAL MF A JOINT PLAT**

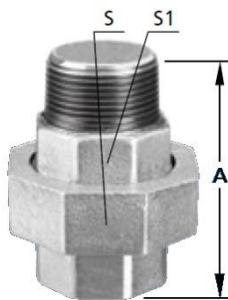

NPS	3/8"	1/2"	3/4"	1"	1"1/4	1"1/2	2"
DN (mm)	12x17	15x21	20x27	26x34	33x42	40x49	50x60
A	58	66	72	80	90	95	106
S (max)	32	41	50	55	70	75	90
S1	20	25	32	39	49	55	69
Poids (Kg)	0.1	0.2	0.34	0.46	0.75	0.9	1.37
Ref. NOIR	331N12	331N15	331N20	331N26	331N33	331N40	331N50
Ref.GALVA	331G12	331G15	331G20	331G26	331G33	331G40	331G50

- ART. 340 : UNION EGAL FF A JOINT CONIQUE**

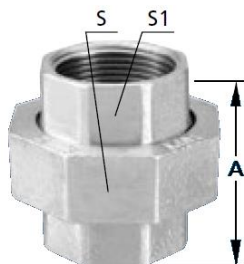

NPS	1/4"	3/8"	1/2"	3/4"	1"	1"1/4	1"1/2	2"	2"1/2	3"	4"
DN (mm)	8x13	12x17	15x21	20x27	26x34	33x42	40x49	50x60	66x76	80x90	102x114
A	42	45	48	52	58	65	70	78	85	95	110
S (max)	27	32	41	50	55	70	75	90	110	130	150
S1	17	20	25	32	39	49	55	69	85	98	124
Poids (Kg)	0.1	0.13	0.17	0.27	0.37	0.62	0.75	1.14	1.78	2.61	3.49
Ref. NOIR	340N8	340N12	340N15	340N20	340N26	340N33	340N40	340N50	340N66	340N80	340N102
Ref.GALVA	340G8	340G12	340G15	340G20	340G26	340G33	340G40	340G50	340G66	340G80	340G102

## RACCORDS FONTE MALLEABLE NOIR ET GALVA BSP TUPY

### DIMENSIONS ( en mm ) :

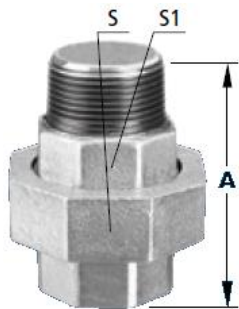

• **ART. 341 : UNION EGAL MF A JOINT CONIQUE**

NPS	3/8"	1/2"	3/4"	1"	1"1/4	1"1/2	2"	2"1/2	3"	4"
DN (mm)	12x17	15x21	20x27	26x34	33x42	40x49	50x60	66x76	80x90	102x114
A	58	66	72	80	90	95	106	118	130	150
S (max)	32	41	50	55	70	75	90	110	130	150
S1	20	25	32	39	49	55	69	85	98	124
Poids (Kg)	0.15	0.21	0.33	0.46	0.79	0.94	1.42	2.58	2.96	4.07
Ref. NOIR	341N12	341N15	341N20	341N26	341N33	341N40	341N50	341N66	341N80	341N102
Ref. GALVA	341G12	341G15	341G20	341G26	341G33	341G40	341G50	341G66	341G80	341G102

• **ART. 370 : PIECE FOLLE FILETEE FEMELLE POUR RACCORD UNION**

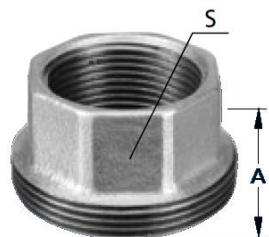

NPS	1/2"	3/4"	1"	1"1/4	1"1/2	2"
DN (mm)	15x21	20x27	26x34	33x42	40x49	50x60
A	24.5	26.5	29	32.5	35	39.5
S	25	32	39	49	55.5	69
Poids (Kg)	0.05	0.1	0.14	0.26	0.24	0.42
Ref. NOIR	370N15	370N20	370N26	370N33	370N40	370N50
Ref. GALVA	370G15	370G20	370G26	370G33	370G40	370G50

• **ART. 374 : ECROU D'UNION POUR RACCORD UNION**

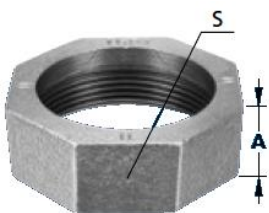

NPS	1/4"	3/8"	1/2"	3/4"	1"	1"1/4	1"1/2	2"	2"1/2	3"	4"
DN (mm)	8x13	12x17	15x21	20x27	26x34	33x42	40x49	50x60	66x76	80x90	102x114
A	16	17	18	20	22	24	25	27	30	31	34
S (max)	32	36	41	50	55	70	75	90	110	130	150
Poids (Kg)	0.04	0.06	0.08	0.11	0.14	0.23	0.24	0.3	0.46	0.86	0.92
Ref. NOIR	374N8	374N12	374N15	374N20	374N26	374N33	374N40	374N50	374N66	374N80	374N102
Ref. GALVA	374G8	374G12	374G15	374G20	374G26	374G33	374G40	374G50	374G66	374G80	374G102

• **ART. 529A : ALLONGE MF EGALE**



NPS	1/2"	3/4"	1"	1"1/4
DN (mm)	15x21	20x27	26x34	33x42
C	43	48	55	60
Poids (Kg)	0.07	0.1	0.17	0.25
Ref. NOIR	529AN15	529AN20	529AN26	529AN33
Ref. GALVA	529AG15	529AG20	529AG26	529AG33

## RACCORDS FONTE MALLEABLE NOIR ET GALVA BSP TUPY

### NORMALISATIONS :

- Fabricant certifié ISO 9001:2015 et ISO 14001 : 2015
- DIRECTIVE 2014/68/UE : Produits exclus de la directive ( article 4, § 3 )
- Conception suivant la norme NF EN 10242 et ISO 49
- Matériaux suivant la norme EN 1562 et ISO 5922
- Filetage mâle BSP conique suivant ISO 7-1 R et filetage femelle BSP cylindrique suivant ISO 7-1 Rp
- Raccords séries Galvanisés compatibles pour eau potable conformément à l'annexe I de l'arrêté du 29 Mai 1997 relatif aux matériaux et objets utilisés dans les installations fixes de production, de traitement et de distribution d'eau destinée à la consommation humaine
- Certification Allemande **DVGW**
- Certification **UL** pour réseau incendie
- Certification **FM** pour réseau incendie

**PRECONISATIONS :** Les avis et conseils, les indications techniques, les propositions, que nous pouvons être amenés à donner ou à faire, n'impliquent de notre part aucune garantie. Il ne nous appartient pas d'apprécier les cahiers des charges ou descriptifs fournis. Il appartient au client de vérifier l'adéquation entre le choix du matériel et les conditions réelles d'utilisation.

**RACCORDS FONTE MALLEABLE NOIR ET GALVA BSP TUPY**

**INSTRUCTIONS DE MONTAGE :**

*Fig. 1*

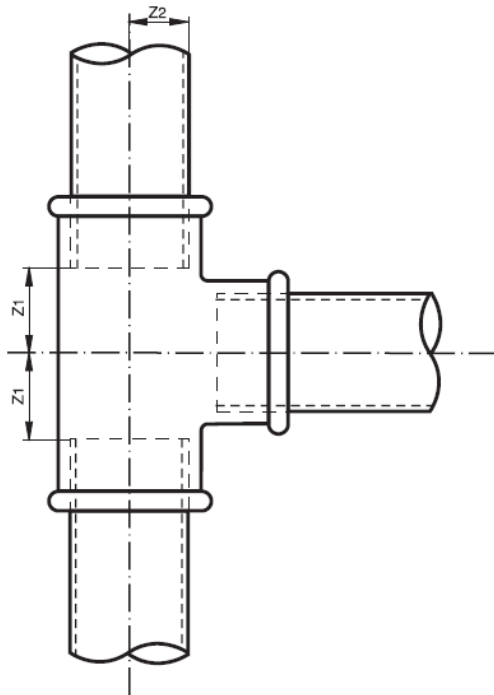

*Fig. 2*

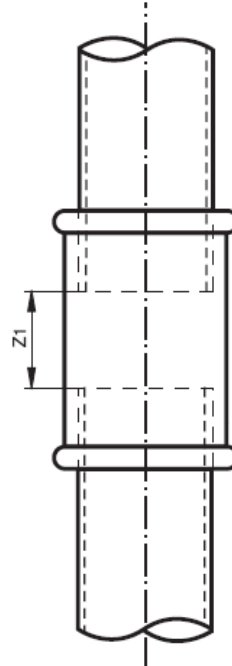

Les cotes de montage  $z1$  et  $z2$  représentent l'écart entre l'extrémité du tube et l'axe du raccord (fig.1) ou l'écart entre deux extrémités des tubes (fig.2).  
Pour calculer les cotes de montage, il faut prendre la longueur constructive et lui soustraire la longueur moyenne de vissage.

Longueur Constructive (mm)	Tolérance (mm)
$\leq 30$	$\pm 1.5$
$> 30 \leq 50$	$\pm 2.0$
$> 50 \leq 75$	$\pm 2.5$
$> 75 \leq 100$	$\pm 3.0$
$> 100 \leq 150$	$\pm 3.5$
$> 150 \leq 200$	$\pm 4.0$
$> 200$	$\pm 5.0$