



Product designation	MINIATURE RELAYS		
Product type designation	HR401C		
Contact characteristics			
Contact configuration			1 C/O
Rated insulation voltage U_i IEC/EN	V		250
Rated impulse withstand voltage U_{imp}	kV		4
IEC Conventional free air thermal current I_{th}	A		10
Rated current (I_n)	A		10
Relay control voltage	V		230VAC
Max contrrollable power in		AC-1	W 2500
Rated operating power AC-1			VA 2500
Single-phase motor control		230VAC	kW 0.25
Minimum switching load		V / mA	5 / 100
Contact impedance		m Ω	50
Contact material			AgSnO ₂
Operating times			
Closing		ms	<20
Opening		ms	<10
Operations			
Mechanical life		cycles	10000000
Electrical life AC1		cycles	100000
Coil characteristics			
Average coil consumption AC at 20°C		VA	1
Operating range		Closing	% U_n 80...110
		Opening	% U_n >10
Maximum cycle frequency		cycles/h	1800
Mechanical features			
Max socket terminal tightening torque		Nm	0.6
Socket screw tightening tool (cross / flat blade)			PH1 / 4.5mm
Conductor section	AWG/Kcmil		
		min	20
		max	14
	IEC		
		min	mm ² 0.5
		max	mm ² 2.5
Operating position		normal	Any

Fixing	On 35mm DIN rail and with screw
--------	---------------------------------

Ambient conditions

Temperature	Operating temperature	min	°C	-40
		max	°C	+85
	Storage temperature	min	°C	-40
		max	°C	+85

Other features

Indication	No
Mechanical contact position indicator	No
Mechanical test actuator	No

Dimensions

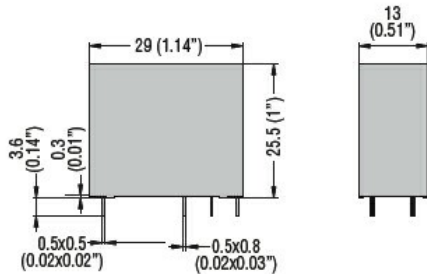

PCB layout

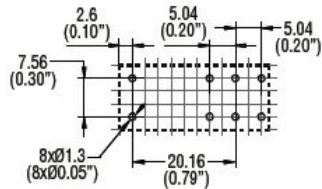

Wiring diagrams

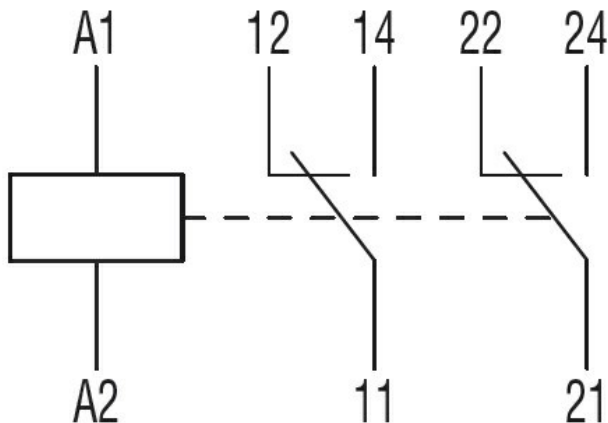

Certifications and compliance

Compliance	IEC/EN 61810
Certificates	cURus VDE

ETIM classification

ETIM 8.0

EC001437 –
Switching relay