



# V2D611D-MLSBE5

Lector61x

IMAGE-BASED CODE READERS

**SICK**  
Sensor Intelligence.



### Ordering information

Type	Part no.
V2D611D-MLSBE5	1115203

Other models and accessories → [www.sick.com/Lector61x](http://www.sick.com/Lector61x)



### Detailed technical data

#### Features

<b>Optical focus</b>	Teach auto focus (liquid lens)
<b>Sensor</b>	CMOS matrix sensor, grayscale values
<b>Sensor resolution</b>	1,280 px x 960 px
<b>Illumination</b>	Integrated
<b>Illumination color</b>	Amber, LED, Visible, 617 nm, ± 15 nm Blue, LED, Visible, 470 nm, ± 15 nm
<b>Feedback spot</b>	LED, Visible, green, 525 nm, ± 15 nm LED, Visible, Red, 635 nm, ± 15 nm
<b>Alignment aid</b>	LED, Red, 630 nm, ± 15 nm
<b>LED class</b>	1 (IEC 62471:2006-07, EN 62471:2008-09)
<b>Laser class</b>	1, complies with 21 CFR 1040.10 except for the conformance according to "Laser Notice No. 56" from May 8, 2019 (IEC 60825-1:2014, EN 60825-1:2014+A11:2021)
<b>Lens</b>	
	Focal length 6 mm
<b>Reading distance</b>	50 mm ... 300 mm <sup>1) 2)</sup>
<b>Scanning frequency</b>	40 Hz
<b>Code resolution</b>	0.05 mm <sup>2)</sup>

<sup>1)</sup> Valid for Data Matrix, PDF417, and 1D codes with good print quality.

<sup>2)</sup> For details see reading field diagram.

#### Mechanics/electronics

<b>Connection type</b>	1 x Cable with M12 male connector, 17-pin 1 x Cable with M12 Ethernet socket, 4-pin Circular plug-in connector
------------------------	--

<b>Supply voltage</b>	12 V DC ... 24 V DC, ± 15 %
<b>Power consumption</b>	Typ. 3.5 W
<b>Output current</b>	≤ 50 mA
<b>Housing</b>	Zinc diecast
<b>Housing color</b>	Light blue (RAL 5012)
<b>Window material</b>	Plastic
<b>Enclosure rating</b>	IP65 (EN 60529, EN 60529/A2)
<b>Protection class</b>	III
<b>Electrical safety</b>	EN 62368-1
<b>Weight</b>	165 g
<b>Dimensions (L x W x H)</b>	50 mm x 40.3 mm x 29.6 mm

### Performance

<b>Readable code structures</b>	1D codes, 2D codes, Stacked, direct-marked codes
<b>Bar code types</b>	GS1-128 / EAN 128, UPC / GTIN / EAN, Interleaved 2 of 5, Pharmacode, GS1 DataBar, Code 39, Code 128, Codabar, Code 32, Code 93, Plessey Code, MSI/Plessey, Telepen, postal codes
<b>2D code types</b>	Data Matrix ECC200, GS1 Data-Matrix, PDF417, PDF417 Truncated, QR code, MaxiCode
<b>Code qualification</b>	On the basis of ISO/IEC 16022, ISO/IEC 15415, ISO/IEC 15416, ISO/IEC 18004
<b>No. of codes per reading interval</b>	1 ... 50
<b>No. of characters per reading interval</b>	500 (for multiplexer function in CAN operation)
<b>Exposure time</b>	≥ 60 μs
<b>Automated parameter switching</b>	✓

### Interfaces

<b>Ethernet</b>	✓, TCP/IP
Function	Data interface (read result output), FTP (image transmission)
Data transmission rate	10/100 MBit/s
<b>PROFINET</b>	✓
Function	PROFINET Single Port
Data transmission rate	10/100 MBit/s
<b>EtherNet/IP™</b>	✓
Data transmission rate	10/100 MBit/s
<b>Serial</b>	✓, RS-232
Function	Data interface (read result output)
Data transmission rate	0.3 kBaud ... 115.2 kBaud
<b>CAN</b>	✓
Function	SICK CAN sensor network CSN (CAN controller/CAN device, multiplexer/server)
Data transmission rate	20 kbit/s ... 1 Mbit/s
<b>CANopen</b>	✓
Data transmission rate	20 kbit/s ... 1 Mbit/s
<b>Digital inputs</b>	2 (physical, switching, "Sensor 1", "Sensor 2")
<b>Digital outputs</b>	3 (physical, switching, "Result 1" ... "Result 3")
<b>Reading pulse</b>	Digital inputs, non-powered, serial interface, Ethernet, CAN, auto pulse, presentation mode
<b>Optical indicators</b>	9 LEDs (6 status displays, 2 LED alignment aids, 1 feedback spot)

<b>Control elements</b>	1 pushbutton (select and start/stop functions)
<b>Operator interfaces</b>	Web server
<b>Configuration software</b>	SOPAS ET
<b>Data storage and retrieval</b>	Image and data storage via external FTP
<b>Maximum encoder frequency</b>	300 Hz
<b>External illumination control</b>	Via digital output (max. 24 V trigger)

### Ambient data

<b>Electromagnetic compatibility (EMC)</b>	EN 61000-6-3:2007+A1:2011 / IEC 61000-6-3:2006+AMD1:2010 EN 61000-6-2:2005-08
<b>Vibration resistance</b>	EN 60068-2-6:2008-02
<b>Shock resistance</b>	EN 60068-2-27:2009-05
<b>Ambient operating temperature</b>	0 °C ... +40 °C <sup>1)</sup>
<b>Storage temperature</b>	-20 °C ... +70 °C
<b>Permissible relative humidity</b>	90 %, Non-condensing

<sup>1)</sup> For ambient operating temperatures of  $\geq 35$  °C, mount the device using an aluminum mounting bracket (e.g., part number 2113160, 2112790).

### Classifications

<b>ECLASS 5.0</b>	27280103
<b>ECLASS 5.1.4</b>	27280103
<b>ECLASS 6.0</b>	27280103
<b>ECLASS 6.2</b>	27280103
<b>ECLASS 7.0</b>	27280103
<b>ECLASS 8.0</b>	27280103
<b>ECLASS 8.1</b>	27280103
<b>ECLASS 9.0</b>	27280103
<b>ECLASS 10.0</b>	27280103
<b>ECLASS 11.0</b>	27280103
<b>ECLASS 12.0</b>	27280103
<b>ETIM 5.0</b>	EC002550
<b>ETIM 6.0</b>	EC002550
<b>ETIM 7.0</b>	EC002999
<b>ETIM 8.0</b>	EC002999
<b>UNSPSC 16.0901</b>	43211701

Dimensional drawing (Dimensions in mm (inch))

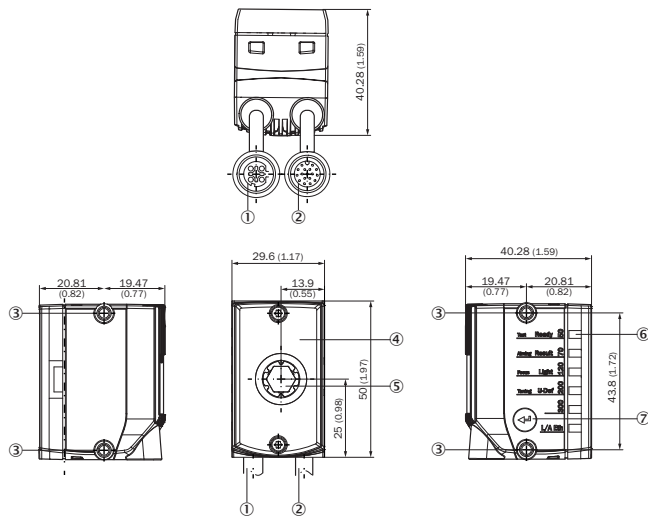

- ① Connecting cable with "Ethernet" connection (female connector, M12, 4-pin, D-coded), length of cable: 0.25 m
- ② Connecting cable with "Power/Serial Data/CAN/I/O" connection (male connector, M12, 17-pin, A-coded), length of cable: 0.35 m
- ③ 4 x M4 blind tapped holes, 6.4 mm deep for mounting the device
- ④ Viewing window with 8 integrated illumination LEDs, 2 LED alignment aids, 1 feedback LED, 1 time-of-flight sensor
- ⑤ Optics, manual focus adjustment with the help of a focus adjustment tool
- ⑥ 6 status LEDs to display the focus position and working distance, device status and device function (3 display levels)
- ⑦ Function key

Field of view

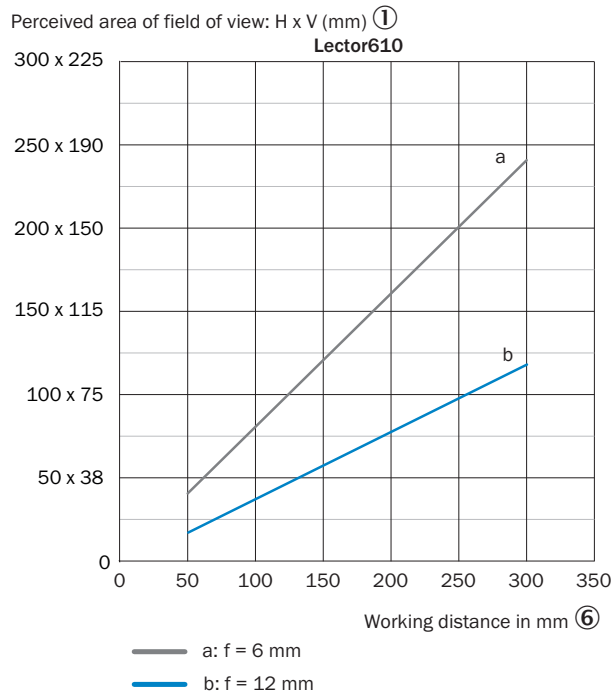

Minimum resolution in mm (f = 6 mm) ②

1D code ③ 2D code ④

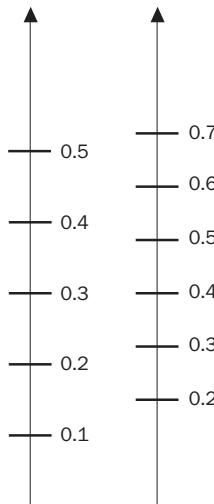

Min. resolution in mm (f = 12 mm) ⑤

1D code ③ 2D code ④

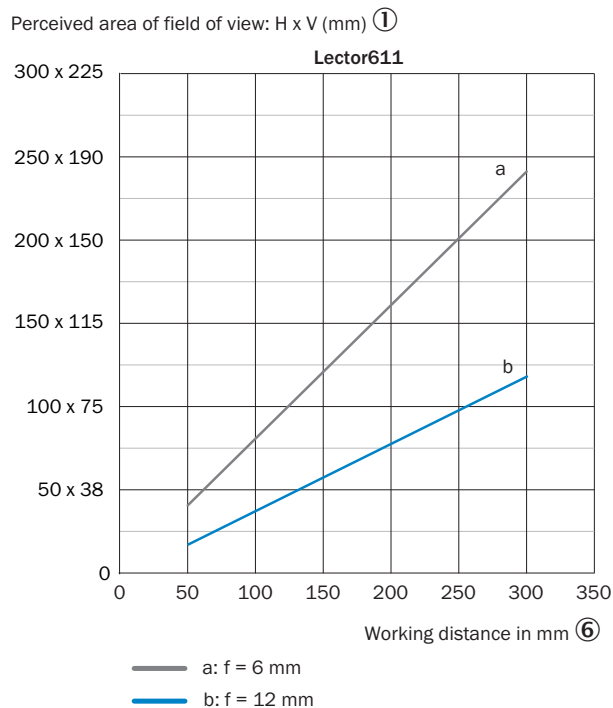
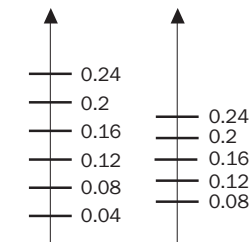

Minimum resolution in mm (f = 6 mm) ②

1D code ③ 2D code ④

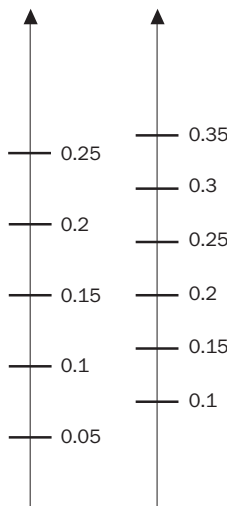

Min. resolution in mm (f = 12 mm) ⑤

1D code ③ 2D code ④

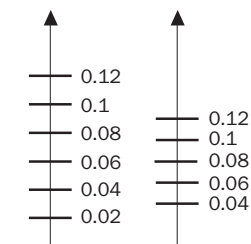





- ① Perceived field of view area: horizontal x vertical (mm)
- ② Minimum resolution in mm (f = 6 mm)
- ③ 1D code
- ④ 2D code

- ⑤ Minimum resolution in mm (f = 12 mm)
- ⑥ Working distance in mm

## Recommended accessories

Other models and accessories → [www.sick.com/Lector61x](http://www.sick.com/Lector61x)

	Brief description	Type	Part no.
Plug connectors and cables			
	<ul style="list-style-type: none"> <li>• <b>Connection type head A:</b> Female connector, M12, 17-pin, straight, A-coded</li> <li>• <b>Connection type head B:</b> Flying leads</li> <li>• <b>Signal type:</b> Sensor/actuator cable</li> <li>• <b>Cable:</b> 2 m, 17-wire, PUR</li> <li>• <b>Description:</b> Sensor/actuator cable, shielded</li> <li>• <b>Application:</b> Zones with oils and lubricants</li> </ul>	YF2A2D-020UV2XLEAX	2114287
	<ul style="list-style-type: none"> <li>• <b>Connection type head A:</b> Female connector, M12, 17-pin, straight, A-coded</li> <li>• <b>Connection type head B:</b> Flying leads</li> <li>• <b>Signal type:</b> Sensor/actuator cable</li> <li>• <b>Cable:</b> 5 m, 17-wire, PUR</li> <li>• <b>Description:</b> Sensor/actuator cable, shielded</li> <li>• <b>Application:</b> Zones with oils and lubricants</li> </ul>	YF2A2D-050UV2XLEAX	2114296
	<ul style="list-style-type: none"> <li>• <b>Connection type head A:</b> Female connector, M12, 17-pin, straight, A-coded</li> <li>• <b>Connection type head B:</b> Flying leads</li> <li>• <b>Signal type:</b> Sensor/actuator cable</li> <li>• <b>Cable:</b> 10 m, 17-wire, PUR</li> <li>• <b>Description:</b> Sensor/actuator cable, shielded</li> <li>• <b>Application:</b> Zones with oils and lubricants</li> </ul>	YF2A2D-100UV2XLEAX	2114297
	<ul style="list-style-type: none"> <li>• <b>Connection type head A:</b> Male connector, M12, 4-pin, D-coded</li> <li>• <b>Connection type head B:</b> Male connector, M12, 4-pin, D-coded</li> <li>• <b>Signal type:</b> Ethernet</li> <li>• <b>Cable:</b> 2 m, 4-wire, PUR, halogen-free</li> <li>• <b>Description:</b> Ethernet, twisted pair, shielded</li> <li>• <b>Permitted cross-section:</b> ≥ 0.25 mm<sup>2</sup></li> <li>• <b>Application:</b> Zones with oils and lubricants, Drag chain operation</li> </ul>	YM2D24-020EA2M2D24	6034420
	<ul style="list-style-type: none"> <li>• <b>Connection type head A:</b> Male connector, M12, 4-pin, straight, D-coded</li> <li>• <b>Connection type head B:</b> Male connector, RJ45, 4-pin, straight</li> <li>• <b>Signal type:</b> Ethernet, PROFINET</li> <li>• <b>Cable:</b> 2 m, 4-wire, PUR, halogen-free</li> <li>• <b>Description:</b> Ethernet, PROFINET, shielded</li> <li>• <b>Application:</b> Drag chain operation, Zones with oils and lubricants</li> </ul>	YM2D24-020PN1MRJA4	2106182
Modules			
	<ul style="list-style-type: none"> <li>• <b>Sub product family:</b> CDB650</li> <li>• <b>Supported products:</b> Lector® series, CLV62x - CLV64x (depending on type), CLV69x, RFID read/write device, InspectorP series</li> <li>• <b>Brief description:</b> Connection device basic for connecting one sensor with 2 A fuse, 5 cable glands and RS-232 interface to sensor via M12, 17-pin female connector, all outputs available on screw/spring-loaded terminals.</li> </ul>	CDB650-204	1064114

### Recommended services

Additional services → [www.sick.com/Lector61x](http://www.sick.com/Lector61x)

	Type	Part no.
<b>Performance check</b>		
<ul style="list-style-type: none"> <li>• <b>Product area:</b> Image-based code readers</li> <li>• <b>Range of services:</b> Inspection of defined functions, e.g., reading performance</li> <li>• <b>Travel expenses:</b> The prices do not include travel costs such as hotel, flight, travel time and expenses.</li> <li>• <b>Duration:</b> Additional work will be invoiced separately</li> </ul>	Performance check Lector	1608207
<b>Maintenance</b>		
<ul style="list-style-type: none"> <li>• <b>Product area:</b> Image-based code readers</li> <li>• <b>Range of services:</b> Inspection, analysis and restoring of defined functions, Inspection and adaptation of previously defined functions of possible Lector6xx illumination, code configuration, trigger and digital inputs, interfaces and digital outputs as well as data processing</li> <li>• <b>Duration:</b> Additional work will be invoiced separately</li> <li>• <b>Travel expenses:</b> The prices do not include travel costs such as hotel, flight, travel time and expenses.</li> </ul>	Maintenance Lector	1611421
<b>Commissioning</b>		
<ul style="list-style-type: none"> <li>• <b>Product area:</b> Image-based code readers</li> <li>• <b>Range of services:</b> Inspection of connection, fine adjustment, optimization of parameters of SICK product as well as tests, Set-up of previously defined functions of possible illumination, code configuration, trigger and digital inputs, interfaces and digital outputs as well as data processing</li> <li>• <b>Travel expenses:</b> The prices do not include travel costs such as hotel, flight, travel time and expenses.</li> <li>• <b>Duration:</b> Additional work will be invoiced separately</li> </ul>	Commissioning Lector	1608206
<b>Extended warranty</b>		
<ul style="list-style-type: none"> <li>• <b>Product area:</b> Identification solutions, machine vision, Detection and ranging solutions, safety camera sensors, Safety laser scanners, Safety radar sensors</li> <li>• <b>Range of services:</b> The services correspond to the scope of the statutory manufacturer warranty (SICK general terms of delivery).</li> <li>• <b>Duration:</b> Five-year warranty from delivery date.</li> </ul>	Extended warranty for a total of five years from delivery date	1680671



## SICK AT A GLANCE

SICK is one of the leading manufacturers of intelligent sensors and sensor solutions for industrial applications. A unique range of products and services creates the perfect basis for controlling processes securely and efficiently, protecting individuals from accidents and preventing damage to the environment.

We have extensive experience in a wide range of industries and understand their processes and requirements. With intelligent sensors, we can deliver exactly what our customers need. In application centers in Europe, Asia and North America, system solutions are tested and optimized in accordance with customer specifications. All this makes us a reliable supplier and development partner.

Comprehensive services complete our offering: SICK LifeTime Services provide support throughout the machine life cycle and ensure safety and productivity.

For us, that is “Sensor Intelligence.”

## WORLDWIDE PRESENCE:

Contacts and other locations –[www.sick.com](http://www.sick.com)