



# V2D654P-2MCXXA6

InspectorP65x

2D MACHINE VISION

**SICK**  
Sensor Intelligence.



### Ordering information

Type	Part no.
V2D654P-2MCXXA6	1082304

Other models and accessories → [www.sick.com/InspectorP65x](http://www.sick.com/InspectorP65x)



### Detailed technical data

#### Features

<b>Task</b>	Classification Identifying Position determination 1D code 2D code Presence inspection Quality check Measuring, 2D OCR
<b>Technology</b>	2D snapshot
<b>Product category</b>	Programmable
<b>SensorApp</b>	Nova InspectorP
<b>License included</b>	Quality Inspection License Optional upgrade with the Intelligent Inspection Upgrade License, which enables productive use of the complete toolset.
<b>Sensor</b>	CMOS matrix sensor, grayscale values
<b>Shutter technology</b>	Global-Shutter
<b>Optical focus</b>	Adjustable focus
<b>Illumination</b>	To be ordered separately as accessories
<b>Alignment aid</b>	Laser, Red, 630 nm ... 680 nm
<b>Laser class</b>	1, complies with 21 CFR 1040.10 except for the conformance according to "Laser Notice No. 50" from June 24, 2007 (IEC 60825-1:2014, EN 60825-1:2014)
<b>Spectral range</b>	Approx. 400 nm ... 900 nm
<b>Lens</b>	C-mount
	Optical format 1"
	Note To be ordered separately as accessories

## Mechanics/electronics

<b>Connection type</b>	1 x M12, 17-pin male connector (serial, I/Os, voltage supply) 1 x M8, 4-pin female connector (USB, not used) 2 x M12, 8-pin female connector (Gigabit Ethernet, only one connection used)
<b>Supply voltage</b>	24 V DC, $\pm 20\%$
<b>Power consumption</b>	Typ. 20 W, $\pm 20\%$
<b>Enclosure rating</b>	IP65 (EN 60529 (1991-10), EN 60529/A2 (2002-02))
<b>Protection class</b>	III (EN 60950-1 (2014-08))
<b>Housing material</b>	Aluminum die cast
<b>Window material</b>	Glass
<b>Weight</b>	635 g
<b>Dimensions (L x W x H)</b>	142 mm x 90 mm x 46 mm <sup>1)</sup>

<sup>1)</sup> Housing only, without lens and optics protection hood.

## Performance

<b>Sensor resolution</b>	2,048 px x 2,048 px (4.2 Mpixel)
<b>Scan/frame rate</b>	40 Hz

## Interfaces

<b>Serial</b>	✓, RS-232, RS-422
Data transmission rate	300 Baud ... 115.2 kBaud
<b>Ethernet</b>	✓, TCP/IP
Function	FTP, HTTP
Data transmission rate	10/100/1,000 Mbit/s
<b>CAN</b>	✓
Function	SICK CAN sensor network (CAN controller/CAN device)
<b>EtherNet/IP™</b>	✓
Data transmission rate	10/100/1,000 Mbit/s
<b>PROFINET</b>	✓
Function	PROFINET Single Port, PROFINET Dual Port (optional via external connection module CDF600-2)
Data transmission rate	10/100 MBit/s
<b>Operator interfaces</b>	Web server
<b>Configuration software</b>	SICK AppStudio
<b>Data storage and retrieval</b>	Image and data logging via microSD memory card and external FTP
<b>Inputs/outputs</b>	2 opto-decoupled inputs, 4 inputs/outputs, configurable
<b>Output current</b>	$\leq 100$ mA
<b>Maximum encoder frequency</b>	1 kHz
<b>External illumination</b>	Via digital output (max. 24 V trigger)
<b>Control elements</b>	2 buttons
<b>Optical indicators</b>	21 LEDs (10 x status display, 10 x LED bar graph, 1 green feedback spot)
<b>Acoustic indicators</b>	Beeper

### Ambient data

<b>Shock load</b>	EN 60068-2-27:2009-05
<b>Vibration load</b>	EN 60068-2-6:2008-02
<b>Ambient operating temperature</b>	0 °C ... +50 °C <sup>1)</sup>
<b>Storage temperature</b>	-20 °C ... +70 °C <sup>1)</sup>

<sup>1)</sup> Permissible relative air humidity: 0 % ... 90 % (non-condensing).

### Classifications

<b>ECLASS 5.0</b>	27310205
<b>ECLASS 5.1.4</b>	27310205
<b>ECLASS 6.0</b>	27310205
<b>ECLASS 6.2</b>	27310205
<b>ECLASS 7.0</b>	27310205
<b>ECLASS 8.0</b>	27310205
<b>ECLASS 8.1</b>	27310205
<b>ECLASS 9.0</b>	27310205
<b>ECLASS 10.0</b>	27310205
<b>ECLASS 11.0</b>	27310205
<b>ECLASS 12.0</b>	27310205
<b>ETIM 5.0</b>	EC001820
<b>ETIM 6.0</b>	EC001820
<b>ETIM 7.0</b>	EC001820
<b>ETIM 8.0</b>	EC001820
<b>UNSPSC 16.0901</b>	43211731

## Dimensional drawing (Dimensions in mm (inch))

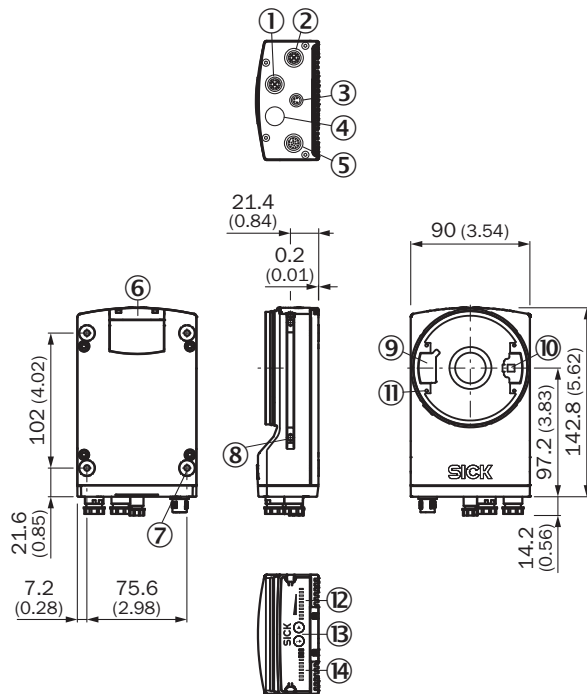

- ① "Ethernet" P1 connection
- ② P3 connection "Ethernet"
- ③ X2 "USB" connection or "trigger external lighting", depending on type
- ④ P2 connection "CAN OUT", depending on type
- ⑤ X1 "Power/Serial Data/CAN/I/O" connection or "CAN IN", depending on type
- ⑥ Cover for the microSD memory card
- ⑦ M5 blind tapped holes, 5 mm deep (4 x), for mounting the sensor
- ⑧ Sliding nut M5, 5.5 mm deep (2 x), for mounting (as alternative)
- ⑨ Plug connector for connecting the integrated lighting
- ⑩ Laser alignment aid exit
- ⑪ 2.5 mm blind tapped holes (4 x) for mounting the spacers for the integrable illumination
- ⑫ Bar graph display
- ⑬ Function button (2 x)
- ⑭ LED for status display (2 levels), 10 x

### Field of view

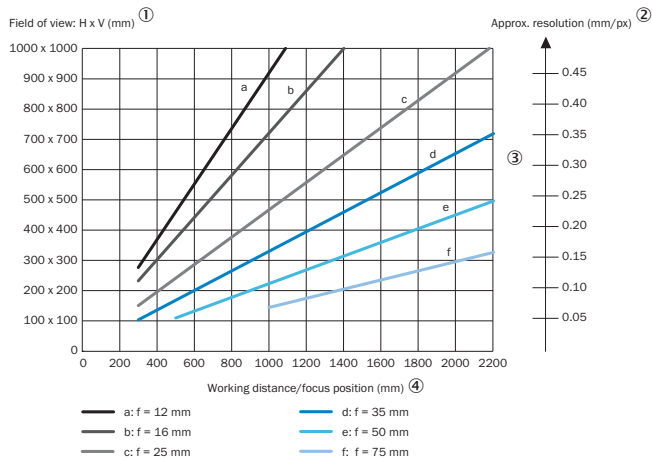

- ① Field of view: Horizontal x vertical in mm
- ② Approximate resolution in mm/px
- ③ Lens focal length
- ④ Working distance/Focus position in mm

Selection Guide

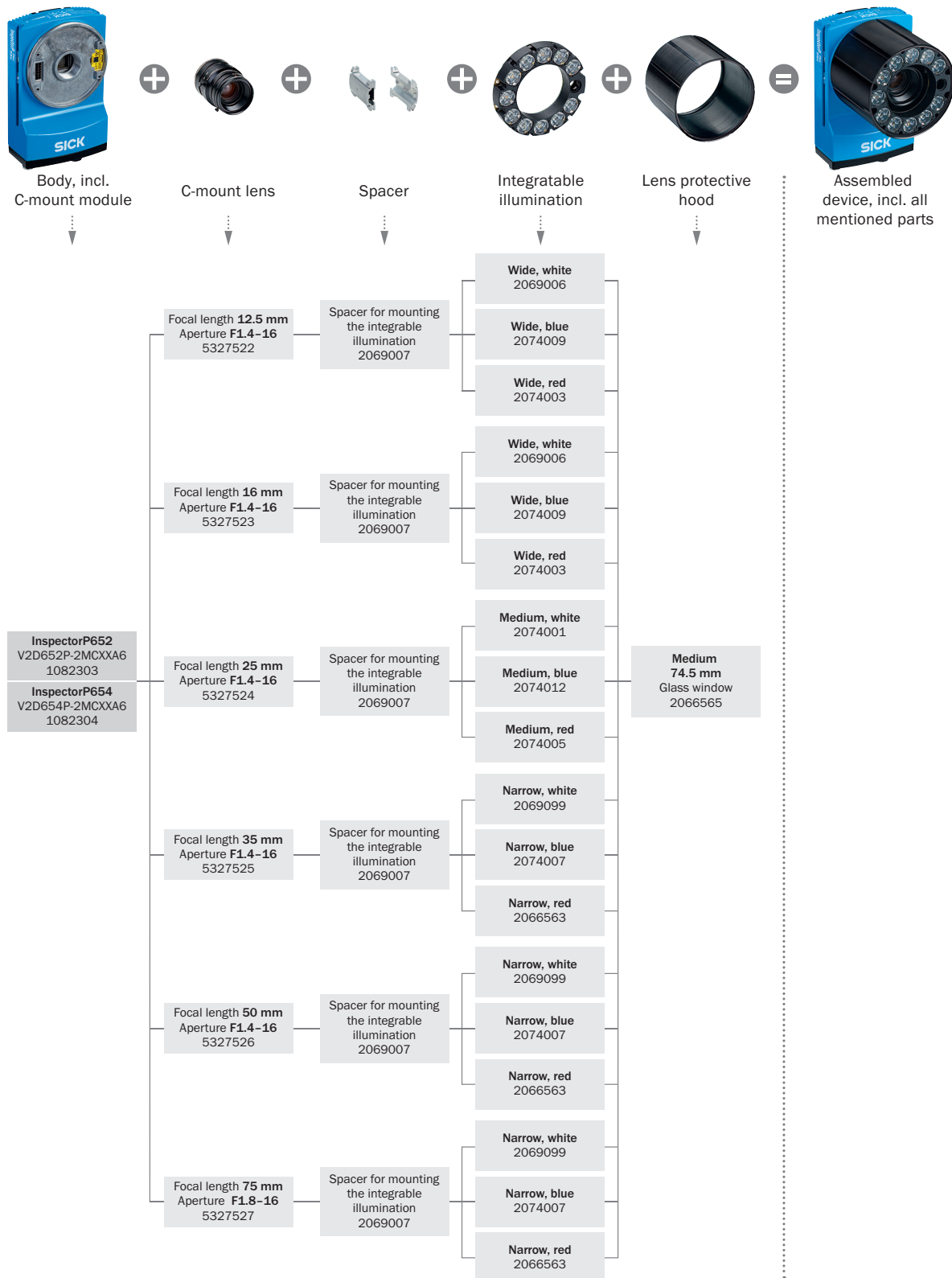



### Overview

SICK AppSpace







### Recommended accessories

Other models and accessories → [www.sick.com/InspectorP65x](http://www.sick.com/InspectorP65x)

	Brief description	Type	Part no.
<b>Lenses and accessories</b>			
	Optics kit 03 incl. lens with focal distance 25 mm, white illumination, spacer and optics protective hood	Optics kit 03	1064793
<b>Mounting brackets and plates</b>			
	Mounting bracket set consisting of mounting angle, cooling plate and screw including skew angle display	Mounting bracket kit	2069171



	Brief description	Type	Part no.
Other mounting accessories			
	Sliding nut, M5, short	Sliding nut	5324896
Plug connectors and cables			
	<ul style="list-style-type: none"> <li>• <b>Connection type head A:</b> Male connector, M12, 8-pin, straight, X-coded</li> <li>• <b>Connection type head B:</b> Male connector, RJ45, 8-pin, straight</li> <li>• <b>Signal type:</b> Ethernet, Gigabit Ethernet</li> <li>• <b>Cable:</b> 2 m, 8-wire, PUR, halogen-free</li> <li>• <b>Description:</b> Ethernet, Gigabit Ethernet, shielded</li> <li>• <b>Application:</b> Zones with oils and lubricants</li> </ul>	YM2X18-020EG1MRJA8	2106258
Others			
	<ul style="list-style-type: none"> <li>• <b>Connection type head A:</b> Female connector, M12, 17-pin, straight, A-coded</li> <li>• <b>Connection type head B:</b> Male connector, M12, 17-pin, straight, A-coded</li> <li>• <b>Signal type:</b> Power, serial, CAN, digital I/Os</li> <li>• <b>Cable:</b> 3 m, 17-wire</li> <li>• <b>Description:</b> Power, serial, CAN, digital I/Os, suitable for 2 A, shielded, to connection module CDB650</li> <li>• <b>Application:</b> Drag chain operation</li> </ul>	YM2A8D-030XXXF2A8D	6051194
Modules			
	<ul style="list-style-type: none"> <li>• <b>Sub product family:</b> CDB650</li> <li>• <b>Supported products:</b> Lector® series, CLV62x - CLV64x (depending on type), CLV69x, RFID read/write device, InspectorP series</li> <li>• <b>Brief description:</b> Connection device basic for connecting one sensor with 2 A fuse, 5 cable glands and RS-232 interface to sensor via M12, 17-pin female connector, all outputs available on screw/spring-loaded terminals.</li> </ul>	CDB650-204	1064114

## Recommended services

Additional services → [www.sick.com/InspectorP65x](http://www.sick.com/InspectorP65x)

	Type	Part no.
Extended warranty		
<ul style="list-style-type: none"> <li>• <b>Product area:</b> Identification solutions, machine vision, Detection and ranging solutions, safety camera sensors, Safety laser scanners, Safety radar sensors</li> <li>• <b>Range of services:</b> The services correspond to the scope of the statutory manufacturer warranty (SICK general terms of delivery).</li> <li>• <b>Duration:</b> Five-year warranty from delivery date.</li> </ul>	Extended warranty for a total of five years from delivery date	1680671

## SICK AT A GLANCE

SICK is one of the leading manufacturers of intelligent sensors and sensor solutions for industrial applications. A unique range of products and services creates the perfect basis for controlling processes securely and efficiently, protecting individuals from accidents and preventing damage to the environment.

We have extensive experience in a wide range of industries and understand their processes and requirements. With intelligent sensors, we can deliver exactly what our customers need. In application centers in Europe, Asia and North America, system solutions are tested and optimized in accordance with customer specifications. All this makes us a reliable supplier and development partner.

Comprehensive services complete our offering: SICK LifeTime Services provide support throughout the machine life cycle and ensure safety and productivity.

For us, that is “Sensor Intelligence.”

## WORLDWIDE PRESENCE:

Contacts and other locations –[www.sick.com](http://www.sick.com)