



# MZC1-2V2DS-KP0

MZC1

SENSORS FOR C-SLOT CYLINDERS

**SICK**  
Sensor Intelligence.



### Ordering information

Type	Part no.
MZC1-2V2DS-KP0	1087247

Other models and accessories → [www.sick.com/MZC1](http://www.sick.com/MZC1)



### Detailed technical data

#### Features

<b>Cylinder type</b>	C-slot
<b>Cylinder types with adapter</b>	SMC rail CDQ2 SMC rail ECDQ2 Round body cylinder Profile cylinders and tie-rod cylinders
<b>Housing length</b>	23.7 mm
<b>Switching frequency</b>	1,000 Hz
<b>Electrical wiring</b>	DC 2-wire
<b>Enclosure rating</b>	IP68

#### Mechanics/electronics

<b>Supply voltage</b>	10 V DC ... 30 V DC
<b>Power consumption</b>	0.8 mA, without load
<b>Voltage drop</b>	≤ 4 V
<b>Continuous current I<sub>a</sub></b>	≤ 40 mA
<b>Protection class</b>	III
<b>Response sensitivity, typ.</b>	2.2 mT
<b>Overrun distance, typ.</b>	4 mm
<b>Hysteresis, typ.</b>	≤ 0.8 mT
<b>Reproducibility</b>	≤ 0.1 mT <sup>1)</sup>
<b>Reverse polarity protection</b>	Yes
<b>Short-circuit protection</b>	Yes
<b>Status indicator LED</b>	Yes
<b>Ambient operating temperature</b>	-30 °C ... +80 °C
<b>Shock and vibration resistance</b>	30 g, 11 ms / 10 ... 55 Hz, 1 mm
<b>EMC</b>	According to EN 60947-5-2
<b>Connection type</b>	Cable with connector M8, 2-pin, drag chain use, 0.3 m

<sup>1)</sup> Supply voltage U<sub>B</sub> and constant ambient temperature T<sub>a</sub>.

<b>Connection type Detail</b>	
Conductor cross section	0.09 mm <sup>2</sup>
Cable diameter	Ø 2.2 mm
Bending radius	With fixed installation > 2 x cable diameter For flexible use > 5 x cable diameter
Torsion force	± 270° / 0.1 m
Torsion cycles	300,000
Drag chain cycles	5,000,000
Drag chain parameters	Traversing speed max. 3 m/s Acceleration max. 10 m/s <sup>2</sup> Bending cycles in the drag chain min. 5 million
Cable outlet	Axial
<b>Material</b>	
Housing	Plastic
Cable	PUR
<b>UL File No.</b>	NRKH.E181493 & NRKH7.E181493

<sup>1)</sup> Supply voltage  $U_B$  and constant ambient temperature  $T_a$ .

### Safety-related parameters

<b>MTTF<sub>D</sub></b>	1,992 years
<b>DC<sub>avg</sub></b>	0 %
<b>T<sub>M</sub> (mission time)</b>	20 years

### Classifications

<b>ECLASS 5.0</b>	27270104
<b>ECLASS 5.1.4</b>	27270104
<b>ECLASS 6.0</b>	27270104
<b>ECLASS 6.2</b>	27270104
<b>ECLASS 7.0</b>	27270104
<b>ECLASS 8.0</b>	27270104
<b>ECLASS 8.1</b>	27270104
<b>ECLASS 9.0</b>	27270104
<b>ECLASS 10.0</b>	27270104
<b>ECLASS 11.0</b>	27270104
<b>ECLASS 12.0</b>	27274301
<b>ETIM 5.0</b>	EC002544
<b>ETIM 6.0</b>	EC002544
<b>ETIM 7.0</b>	EC002544
<b>ETIM 8.0</b>	EC002544
<b>UNSPSC 16.0901</b>	39122230

## Installation note

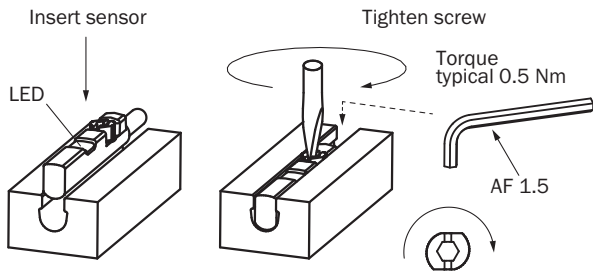

## Connection diagram

Cd-446

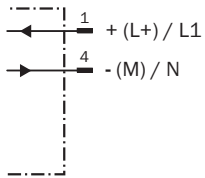

## Dimensional drawing (Dimensions in mm (inch))

Cable with connector M8

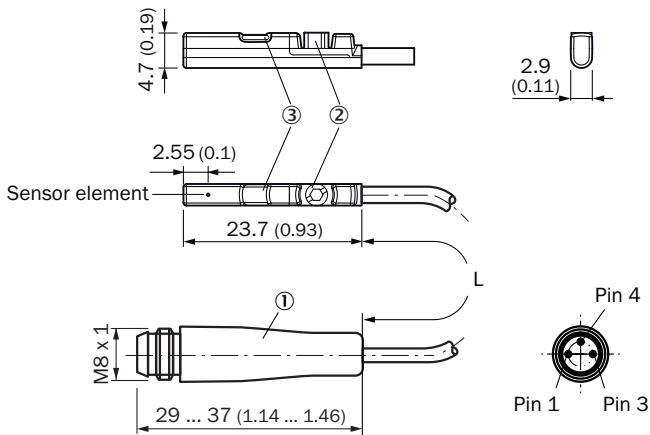





- ① Connection
- ② Fixing screw SW 1.5
- ③ Display LED

Part no.	Type	L	Number of cores
1059735	MZC1-2V2PS-KP0	300 mm	3
1059744	MZC1-2V2NS-KP0	300 mm	3
1059752	MZC1-4V3PS-KP0	300 mm	3
1059757	MZC1-4V3NS-KP0	300 mm	3
1087247	MZC1-2V2DS-KP0	300 mm	2

Recommended accessories

Other models and accessories → [www.sick.com/MZC1](http://www.sick.com/MZC1)

	Brief description	Type	Part no.
<b>Brackets for cylinder sensors</b>			
	Mounting bracket for integrated profile cylinder/tie-rod cylinder, zinc diecast, mounting hardware included	BEF-KHZ-PC1	2076170
	1 piece, Mounting bracket on round body cylinder with piston diameter of 12 mm, ambient temperature min 0 °C max 50 °C, plastic, Aluminum	BEF-KHZ-RC-12	2077673
	1 piece, Mounting bracket on round body cylinder with piston diameter of 16 mm, ambient temperature min 0 °C max 50 °C, plastic, Aluminum	BEF-KHZ-RC-16	2077672
	1 piece, Mounting bracket on round body cylinder with piston diameter of 20 mm, ambient temperature min 0 °C max 50 °C, plastic, Aluminum	BEF-KHZ-RC-20	2077671
	1 piece, Mounting bracket on round body cylinder with piston diameter of 25 mm, ambient temperature min 0 °C max 50 °C, plastic, Aluminum	BEF-KHZ-RC-25	2077670
	1 piece, Mounting bracket on round body cylinder with piston diameter of 32 mm, ambient temperature min 0 °C max 50 °C, plastic, Aluminum	BEF-KHZ-RC-32	2077669
	1 piece, Mounting bracket on round body cylinder with piston diameter of 40 mm, ambient temperature min 0 °C max 50 °C, plastic, Aluminum	BEF-KHZ-RC-40	2077668
	1 piece, Mounting bracket on round body cylinder with piston diameter of 50 mm, ambient temperature min 0 °C max 50 °C, plastic, Aluminum	BEF-KHZ-RC-50	2077667
	1 piece, Mounting bracket on round body cylinder with piston diameter of 63 mm, ambient temperature min 0 °C max 50 °C, plastic, Aluminum	BEF-KHZ-RC-63	2077666
	1 piece, Mounting bracket on round body cylinder with piston diameter of 1 mm ... 130 mm, ambient temperature min -30 °C max 80 °C, stainless steel, Aluminum	BEF-KHZ-RC1-130	2077686
	1 piece, Mounting bracket on round body cylinder with piston diameter of 1 mm ... 25 mm, ambient temperature min -30 °C max 80 °C, stainless steel, Aluminum	BEF-KHZ-RC1-25	2077685
<b>Plug connectors and cables</b>			
	<ul style="list-style-type: none"> <li>• <b>Connection type head A:</b> Female connector, M8, 3-pin, straight, A-coded</li> <li>• <b>Connection type head B:</b> Flying leads</li> <li>• <b>Signal type:</b> Sensor/actuator cable</li> <li>• <b>Cable:</b> 2 m, 3-wire, PVC</li> <li>• <b>Description:</b> Sensor/actuator cable, unshielded</li> <li>• <b>Application:</b> Zones with chemicals</li> </ul>	YF8U13-020VA1XLEAX	2095860
	<ul style="list-style-type: none"> <li>• <b>Connection type head A:</b> Female connector, M8, 3-pin, straight, A-coded</li> <li>• <b>Connection type head B:</b> Flying leads</li> <li>• <b>Signal type:</b> Sensor/actuator cable</li> <li>• <b>Cable:</b> 5 m, 3-wire, PVC</li> <li>• <b>Description:</b> Sensor/actuator cable, unshielded</li> <li>• <b>Application:</b> Zones with chemicals</li> </ul>	YF8U13-050VA1XLEAX	2095884
	<ul style="list-style-type: none"> <li>• <b>Connection type head A:</b> Female connector, M8, 3-pin, angled, A-coded</li> <li>• <b>Connection type head B:</b> Flying leads</li> <li>• <b>Signal type:</b> Sensor/actuator cable</li> <li>• <b>Cable:</b> 2 m, 3-wire, PUR, halogen-free</li> <li>• <b>Description:</b> Sensor/actuator cable, unshielded</li> <li>• <b>Application:</b> Zones with oils and lubricants, Drag chain operation, Robot</li> </ul>	YG8U13-020UA1XLEAX	2094794
	<ul style="list-style-type: none"> <li>• <b>Connection type head A:</b> Female connector, M8, 3-pin, angled, A-coded</li> <li>• <b>Connection type head B:</b> Flying leads</li> <li>• <b>Signal type:</b> Sensor/actuator cable</li> <li>• <b>Cable:</b> 2 m, 3-wire, PVC</li> <li>• <b>Description:</b> Sensor/actuator cable, unshielded</li> <li>• <b>Application:</b> Zones with chemicals</li> </ul>	YG8U13-020VA1XLEAX	2096165

	Brief description	Type	Part no.
	<ul style="list-style-type: none"> <li>• <b>Connection type head A:</b> Female connector, M8, 3-pin, angled, A-coded</li> <li>• <b>Connection type head B:</b> Flying leads</li> <li>• <b>Signal type:</b> Sensor/actuator cable</li> <li>• <b>Cable:</b> 5 m, 3-wire, PUR, halogen-free</li> <li>• <b>Description:</b> Sensor/actuator cable, unshielded</li> <li>• <b>Application:</b> Zones with oils and lubricants, Drag chain operation, Robot</li> </ul>	YG8U13-050UA1XLEAX	2095586
	<ul style="list-style-type: none"> <li>• <b>Connection type head A:</b> Female connector, M8, 3-pin, angled, A-coded</li> <li>• <b>Connection type head B:</b> Flying leads</li> <li>• <b>Signal type:</b> Sensor/actuator cable</li> <li>• <b>Cable:</b> 5 m, 3-wire, PVC</li> <li>• <b>Description:</b> Sensor/actuator cable, unshielded</li> <li>• <b>Application:</b> Zones with chemicals</li> </ul>	YG8U13-050VA1XLEAX	2096166
	<ul style="list-style-type: none"> <li>• <b>Connection type head A:</b> Female connector, M8, 3-pin, straight</li> <li>• <b>Description:</b> Unshielded</li> <li>• <b>Connection systems:</b> Screw-type terminals</li> <li>• <b>Permitted cross-section:</b> 0.14 mm<sup>2</sup> ... 0.5 mm<sup>2</sup></li> </ul>	DOS-0803-G	7902077
	<ul style="list-style-type: none"> <li>• <b>Connection type head A:</b> Female connector, M8, 3-pin, angled</li> <li>• <b>Description:</b> Unshielded</li> <li>• <b>Connection systems:</b> Solder connection</li> <li>• <b>Permitted cross-section:</b> ≤ 0.25 mm<sup>2</sup></li> </ul>	DOS-0803-W	7902078

## SICK AT A GLANCE

SICK is one of the leading manufacturers of intelligent sensors and sensor solutions for industrial applications. A unique range of products and services creates the perfect basis for controlling processes securely and efficiently, protecting individuals from accidents and preventing damage to the environment.

We have extensive experience in a wide range of industries and understand their processes and requirements. With intelligent sensors, we can deliver exactly what our customers need. In application centers in Europe, Asia and North America, system solutions are tested and optimized in accordance with customer specifications. All this makes us a reliable supplier and development partner.

Comprehensive services complete our offering: SICK LifeTime Services provide support throughout the machine life cycle and ensure safety and productivity.

For us, that is “Sensor Intelligence.”

## WORLDWIDE PRESENCE:

Contacts and other locations –[www.sick.com](http://www.sick.com)