

YN12U14-2550K4051A

Field-attachable connectors

PLUG CONNECTORS AND CABLES

SICK
Sensor Intelligence.



Ordering information

Type	Part no.
YN12U14-2550K4051A	2109295

Please consider the operational voltage of the connector. For sensors with an integrated cable and flying leads the operational voltage of the connector can be lower than the operational voltage of the sensor.

Other models and accessories → www.sick.com/Field-attachable_connectors



Detailed technical data

Technical specifications

Accessory group	Plug connectors and cables
Accessory family	Field-attachable connectors
Connection type head A	Male connector, M12, 4-pin, angled, A-coded
Connection type	IDC quick connection
Locking plug connector	Screw connection
Connector material	TPU
Connector color	Black
Locking nut material	Zinc die-cast, nickel-plated
Seal material	PUR
Tightening torque	0.6 Nm
Width across flats	13
Permitted cross-section	0.25 mm ² ... 0.5 mm ²
Reference voltage	32 V AC 32 V DC
Rated impulse voltage	0.8 kV
Current loading	4 A
Signal type	Sensor/actuator cable
Application	Zones with oils and lubricants
Authorizations	CE
Enclosure rating	IP67
Ambient operating temperature	Head -25 °C ... +85 °C
Contamination rating	3
Insulation resistance	100 MΩ
Overvoltage category	III
Specific insulation resistance	30 mΩ

Classifications

ECLASS 5.0	27279290
ECLASS 5.1.4	27279290
ECLASS 6.0	27279221
ECLASS 6.2	27279221
ECLASS 7.0	27440104
ECLASS 8.0	27440104
ECLASS 8.1	27440104
ECLASS 9.0	27440102
ECLASS 10.0	27440102
ECLASS 11.0	27440102
ECLASS 12.0	27440116
ETIM 5.0	EC002635
ETIM 6.0	EC002635
ETIM 7.0	EC002635
ETIM 8.0	EC002635
UNSPSC 16.0901	39121421

Dimensional drawing (Dimensions in mm (inch))

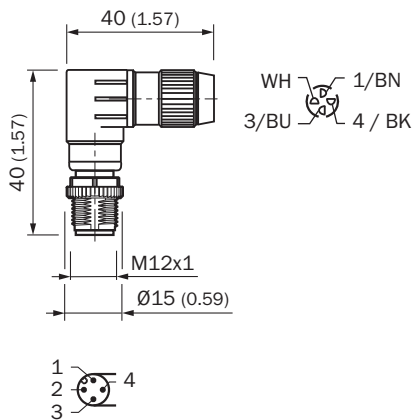

SICK AT A GLANCE

SICK is one of the leading manufacturers of intelligent sensors and sensor solutions for industrial applications. A unique range of products and services creates the perfect basis for controlling processes securely and efficiently, protecting individuals from accidents and preventing damage to the environment.

We have extensive experience in a wide range of industries and understand their processes and requirements. With intelligent sensors, we can deliver exactly what our customers need. In application centers in Europe, Asia and North America, system solutions are tested and optimized in accordance with customer specifications. All this makes us a reliable supplier and development partner.

Comprehensive services complete our offering: SICK LifeTime Services provide support throughout the machine life cycle and ensure safety and productivity.

For us, that is “Sensor Intelligence.”

WORLDWIDE PRESENCE:

Contacts and other locations –www.sick.com