

Part number

TMAP 24.40



Surface mounting housing, T-TYPE series, with 2 levers, M40 cable entry, size "104.27"

Product description

Product type	Surface mounting housing
Series	T-TYPE
Closing type	With 2 levers
Size	Size 104.27
Cable entry	With cable entry M40

Technical data

IP degree of protection IP65

Further technical details

Weight	216,00 g
Operating temperature range (min, max)	-40°C ... +90°C

Material properties

Main material	Polypropylene (PP)
Other materials	Lever: Polyamide (PA) Gasket: polyurethane (PUR)
Colour	RAL 7012 grey, RAL 7001 grey
RoHs conformity	Compliant
China RoHs - EFUP	E
REACH SVHC substances	No

Approvals / Standards

UL	ECBT2
cUL	ECBT8

General ordering information

EAN13 code	8015747168632
eCl@ss 8.1	27440202
ETIM 7.0	EC000437

Packaging Information

Packaging length	330,00 mm
Packaging height	220,00 mm
Packaging width	310,00 mm
Packaging weight	4,32 kg
Packaging volume	22,51 dm ³
Packaging description	Carton box
Packaging quantity	20 Pcs
Packaging EAN code	8015747170949
Sub-packaging weight	1,08 kg
Sub-packaging description	Plastic packaging
Sub-packaging quantity	5 Pcs
Sub-packaging EAN barcode	8015747170338

Part number

TMAP 24.40



Catalogue drawings

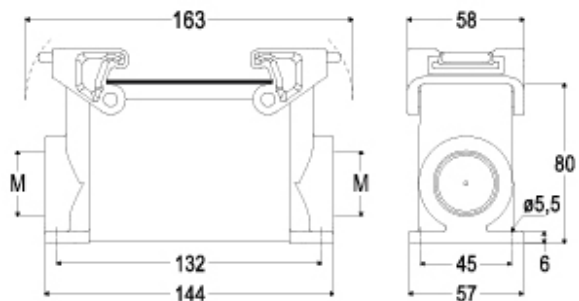

Notes

Dimensions shown in mm are not binding and may be changed without notice.
