

# DBS36E-SDAK02500

DBS36/50

INCREMENTAL ENCODERS

**SICK**  
Sensor Intelligence.

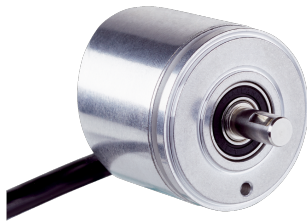

Illustration may differ



### Ordering information

Type	Part no.
DBS36E-SDAK02500	1064245

Other models and accessories → [www.sick.com/DBS36\\_50](http://www.sick.com/DBS36_50)

### Detailed technical data

#### Features

<b>Specialty</b>	For adaption on 1.25 m wire draw
------------------	----------------------------------

#### Performance

<b>Pulses per revolution</b>	2,500
<b>Measuring step</b>	90°, electric/pulses per revolution
<b>Measuring step deviation</b>	± 18° / pulses per revolution
<b>Error limits</b>	± 54° / pulses per revolution
<b>Duty cycle</b>	≤ 0.5 ± 5 %

#### Interfaces

<b>Communication interface</b>	Incremental
<b>Communication Interface detail</b>	TTL / RS-422
<b>Number of signal channels</b>	6-channel
<b>Initialization time</b>	< 3 ms
<b>Output frequency</b>	≤ 300 kHz
<b>Load current</b>	≤ 30 mA
<b>Operating current</b>	≤ 50 mA (without load)

#### Electrical data

<b>Connection type</b>	Cable, 8-wire, universal, 1.5 m
<b>Supply voltage</b>	4.5 ... 5.5 V
<b>Reference signal, number</b>	1
<b>Reference signal, position</b>	90°, electric, logically gated with A and B
<b>Short-circuit protection of the outputs</b>	✓ <sup>1)</sup>
<b>MTTFd: mean time to dangerous failure</b>	600 years (EN ISO 13849-1) <sup>2)</sup>

<sup>1)</sup> The short-circuit rating is only given if Us and GND are connected correctly.

<sup>2)</sup> This product is a standard product and does not constitute a safety component as defined in the Machinery Directive. Calculation based on nominal load of components, average ambient temperature 40°C, frequency of use 8760 h/a. All electronic failures are considered hazardous. For more information, see document no. 8015532.

## Mechanical data

<b>Mechanical design</b>	Solid shaft, Servo flange
<b>Shaft diameter</b>	6 mm Feather key groove
<b>Shaft length</b>	12 mm
<b>Weight</b>	+ 150 g (with connecting cable)
<b>Shaft material</b>	Stainless steel
<b>Flange material</b>	Aluminum
<b>Housing material</b>	Aluminum
<b>Material, cable</b>	PVC
<b>Start up torque</b>	+ 0.5 Ncm (+20 °C)
<b>Operating torque</b>	0.4 Ncm (+20 °C)
<b>Permissible shaft loading</b>	40 N (radial) <sup>1)</sup> 20 N (axial)
<b>Operating speed</b>	6,000 min <sup>-1</sup> <sup>2)</sup>
<b>Maximum operating speed</b>	≤ 8,000 min <sup>-1</sup> <sup>3)</sup>
<b>Moment of inertia of the rotor</b>	0.6 gcm <sup>2</sup>
<b>Bearing lifetime</b>	2 x 10 <sup>9</sup> revolutions
<b>Angular acceleration</b>	≤ 500,000 rad/s <sup>2</sup>

<sup>1)</sup> Higher values are possible using limited bearing life.

<sup>2)</sup> Allow for self-heating of 3.3 K per 1,000 rpm when designing the operating temperature range.

<sup>3)</sup> No permanent operation. Decreasing signal quality.

## Ambient data

<b>EMC</b>	According to EN 61000-6-2 and EN 61000-6-3 (class A)
<b>Enclosure rating</b>	IP65
<b>Permissible relative humidity</b>	90 % (Condensation not permitted)
<b>Operating temperature range</b>	-20 °C ... +85 °C, -35 °C ... +95 °C on request
<b>Storage temperature range</b>	-40 °C ... +100 °C, without package
<b>Resistance to shocks</b>	100 g, 6 ms (EN 60068-2-27)
<b>Resistance to vibration</b>	20 g, 10 Hz ... 2,000 Hz (EN 60068-2-6)

## Classifications

<b>eCl@ss 5.0</b>	27270501
<b>eCl@ss 5.1.4</b>	27270501
<b>eCl@ss 6.0</b>	27270590
<b>eCl@ss 6.2</b>	27270590
<b>eCl@ss 7.0</b>	27270501
<b>eCl@ss 8.0</b>	27270501
<b>eCl@ss 8.1</b>	27270501
<b>eCl@ss 9.0</b>	27270501
<b>eCl@ss 10.0</b>	27270501
<b>eCl@ss 11.0</b>	27270501
<b>eCl@ss 12.0</b>	27270501

<b>ETIM 5.0</b>	EC001486
<b>ETIM 6.0</b>	EC001486
<b>ETIM 7.0</b>	EC001486
<b>ETIM 8.0</b>	EC001486
<b>UNSPSC 16.0901</b>	41112113

### Dimensional drawing (Dimensions in mm (inch))

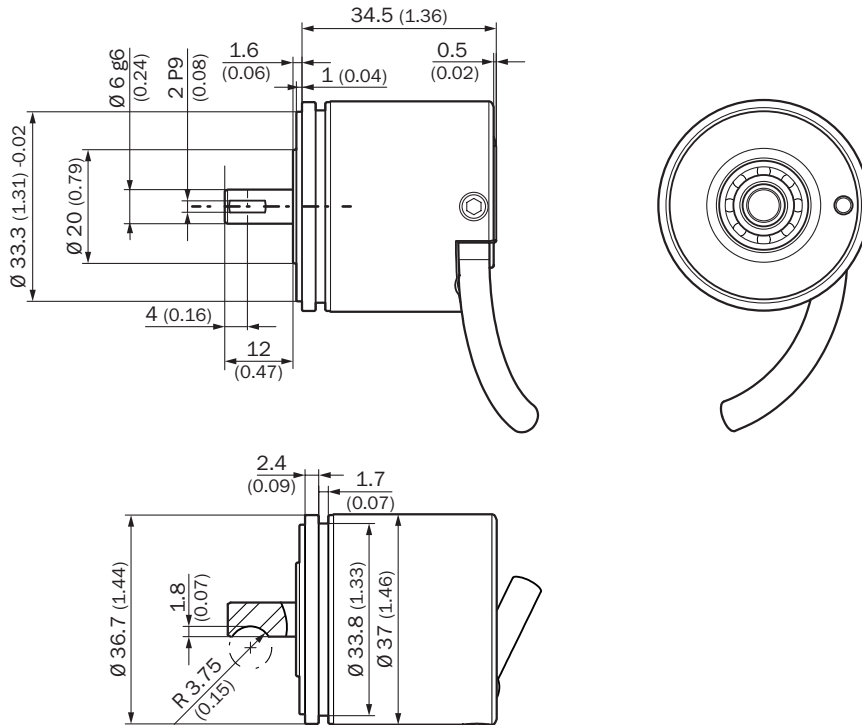

### PIN assignment

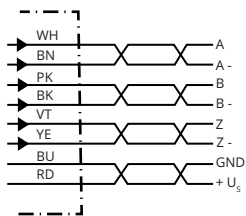

Wire colors (cable connection)	Male connector M12, 8-pin	Male connector M23, 12-pin	TTL/HTL 6-channel signal	Explanation
Brown	1	6	A-	Signal wire
White	2	5	A	Signal wire
Black	3	1	B-	Signal wire
Pink	4	8	B	Signal wire
Yellow	5	4	Z-	Signal wire

Wire colors (cable connection)	Male connector M12, 8-pin	Male connector M23, 12-pin	TTL/HTL 6-channel signal	Explanation
Purple	6	3	Z	Signal wire
Blue	7	10	GND	Ground connection
Red	8	12	+U <sub>s</sub>	Supply voltage
-	-	9	Not assigned	Not assigned
-	-	2	Not assigned	Not assigned
-	-	11	Not assigned	Not assigned
-	-	7	Not assigned	Not assigned
Screen	Screen	Screen	Screen	Screen connected to encoder housing

### Diagrams

Signal outputs for electrical interfaces TTL and HTL

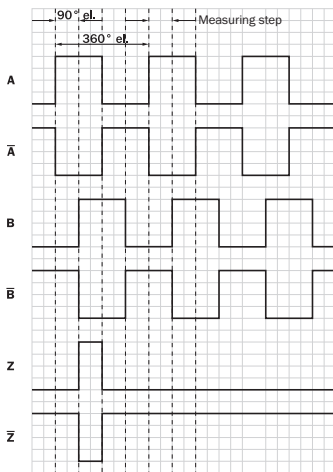































Cw with view on the encoder shaft in direction "A", compare dimensional drawing.

① Interfaces G, P, R only for channels A, B, Z.

Supply voltage	Output
4.5 V...5.5 V	TTL/RS422
7 V...30 V	TTL/RS422
7 V...30 V	HTL/Push Pull
7 V...27 V	HTL/push pull, 3 channel
4.5 V...5.5 V	Open Collector NPN, 3 channel
4.5 V...30 V	Open Collector NPN, 3 channel

### Recommended accessories

Other models and accessories → [www.sick.com/DBS36\\_50](http://www.sick.com/DBS36_50)

	Brief description	Type	Part no.
<b>Other mounting accessories</b>			
	O-ring for measuring wheels (circumference 200 mm)	BEF-OR-053-040	2064061
	O-ring for measuring wheels (circumference 300 mm), 2x O-ring	BEF-OR-083-050	2064076
	O-ring for measuring wheels (circumference 500 mm)	BEF-OR-145-050	2064074
<b>Plug connectors and cables</b>			
		LTG-2308-MWENC	6027529
		LTG-2411-MW	6027530
		LTG-2512-MW	6027531
		LTG-2612-MW	6028516
		STE-1208-GA01	6044892
		STE-2312-G01	2077273
		STE-2312-GX	6028548
<b>Shaft adaptation</b>			
		KUP-0606-B	5312981
		KUP-0606-S	2056406
		KUP-0608-S	5314179
		KUP-0610-B	5312982
		KUP-0610-D	5326697
		KUP-0610-F	5312985
		KUP-0610-J	2127056
		KUP-0610-S	2056407

## SICK AT A GLANCE

SICK is one of the leading manufacturers of intelligent sensors and sensor solutions for industrial applications. A unique range of products and services creates the perfect basis for controlling processes securely and efficiently, protecting individuals from accidents and preventing damage to the environment.

We have extensive experience in a wide range of industries and understand their processes and requirements. With intelligent sensors, we can deliver exactly what our customers need. In application centers in Europe, Asia and North America, system solutions are tested and optimized in accordance with customer specifications. All this makes us a reliable supplier and development partner.

Comprehensive services complete our offering: SICK LifeTime Services provide support throughout the machine life cycle and ensure safety and productivity.

For us, that is “Sensor Intelligence.”

## WORLDWIDE PRESENCE:

Contacts and other locations –[www.sick.com](http://www.sick.com)