

# ECLIPSE EXTERIOR

astro

GB

Products with electronic ballasts / drivers must not be installed on the same electrical circuits as products with inductive loads, for example magnetic fluorescent luminaires, motors or ventilators. Inductive loads can generate excessive voltage surges which can damage electronic ballasts.

The light source in this luminaire shall only be replaced by the manufacturer or his service agent or a similar qualified person.

PLEASE READ THE INSTRUCTIONS CAREFULLY  
BEFORE COMMENCING ASSEMBLY

Live: Normally Brown / Red  
Neutral: Normally Blue / Black  
Earth: Normally Green / Yellow

This product contains a light source of energy efficiency class F to Regulation (EU) No 2019/2015 (01/09/2021)

FR

Les luminaires utilisant un ballast électronique / drivers ne peuvent être installés sur le même circuit que des appareils avec charges inductives, tels que luminaires fluorescents magnétiques, moteurs et ventilateurs. Les charges inductives peuvent générer des voltages excessifs et ainsi endommager les ballasts électroniques.

La source lumineuse de ce luminaire devrait seulement être remplacée par le fabricant ou par un de ses agents de maintenance ou par une personne qualifiée similaire.

LIRE ATTENTIVEMENT LES INSTRUCTIONS  
AVANT DE COMMENCER LE MONTAGE

Phase: Normalement Brun / Rouge  
Neutre: Normalement Bleu / Noir  
Terre: Normalement Vert / Jaune

Ce produit contient une source lumineuse de classe d'efficacité énergétique F selon le règlement (UE) n° 2019/2015 (01/09/2021)

IT

Tutti i prodotti che includono ballast elettronici / driver non devono essere installati sugli stessi circuiti elettrici come anche prodotti con carichi induttivi quali lampadari a fluorescenza magnetica, motori o ventilatori. I carichi induttivi possono generare scariche eccessive che possono danneggiare i ballast.

La sorgente di luce in questo apparecchio può essere sostituita solo dal produttore o da un suo agente di servizio o da una persona qualificata simile.

LEGGERE ATTENTAMENTE LE ISTRUZIONI  
PRIMA DI COMINCIARE L'ASSEMBLAGGIO

Cavo positivo: normalmente marrone o rosso  
Cavo neutro: normalmente blu o nero  
Cavo terra: normalmente verde o giallo

Questo prodotto contiene una sorgente luminosa di classe di efficienza energetica F secondo il regolamento (UE) n° 2019/2015 (01/09/2021)

DE

Produkte mit elektronischen Vorschaltgeräten/ Treibern dürfen nicht im selben Stromkreislauf installiert werden wie Verbraucher mit induktiven Lasten, z.B. magnetische Leuchtstofflampen, Motoren oder Ventilatoren. Induktive Lasten können übermäßige Spannungsspitzen erzeugen, die elektronische Vorschaltgeräte beschädigen könnten.

Die Lichtquelle in dieser Leuchte darf nur vom Hersteller oder seinem Servicemitarbeiter oder einer ähnlich qualifizierten Person ausgetauscht werden.

LESEN SIE BITTE DIE ANWEISUNGEN  
SORGFÄLTIG DURCH, BEVOR SIE MIT DEM  
ZUSAMMENBAUEN BEGINNEN

Phase: Normalerweise Braun / Rot  
Nulleiter: Normalerweise Blau / Schwarz  
Erde: Normalerweise Grün / Gelb

Dieses Produkt enthält eine Lichtquelle der Energieeffizienzklasse F gemäß Verordnung (EU) Nr. 2019/2015 (01/09/2021)

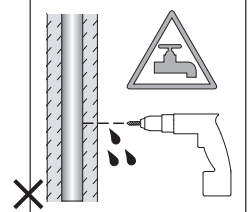
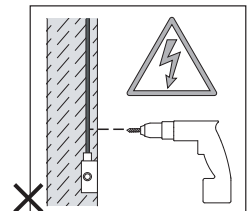
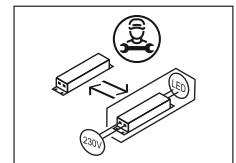
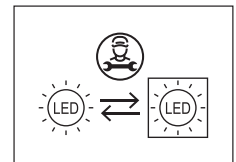

UNSUITABLE FOR DIMMING

Ne convient pour gradateur  
Non dimmerabile  
Nicht zum Dimmen geeignet



FOR WALL USE ONLY

Usage mural uniquement  
Solo per uso a parete  
Nur zur Verwendung als Wandleuchte

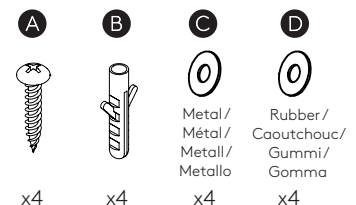
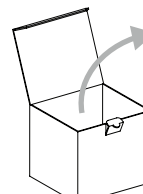
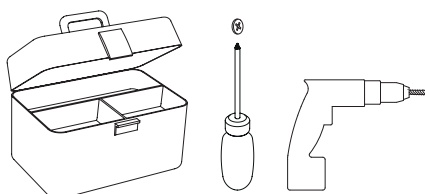

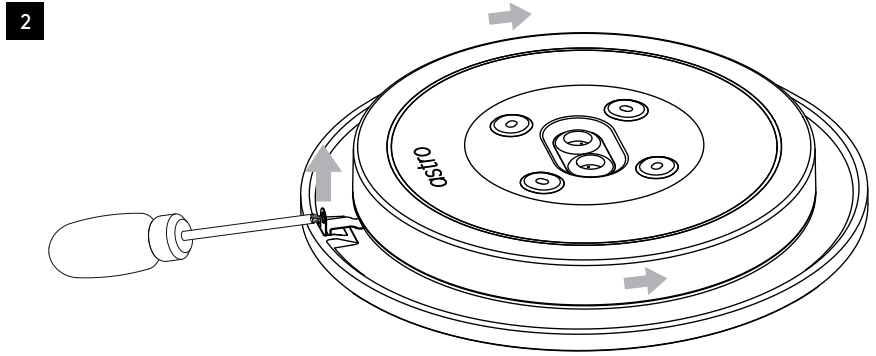
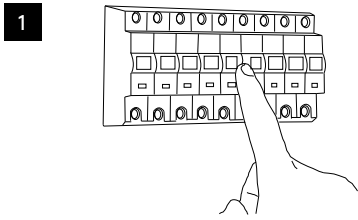

**TURN OFF POWER**  
 Couper Le Courant! / Spegner La Corrente! /  
 Strom Abstopfen!

