



Product designation

Motor protection
circuit breaker
SM1RT

Product type designation

Electrical features

Number of poles	Nr.	3	
Magnetic protection		yes	
Thermal protection		yes	
Phase failure detection		yes	
Rated insulation voltage U_i IEC/EN	V	690	
Rated impulse withstand voltage U_{imp}	kV	6	
Rated frequency	Hz	50/60	
Thermal trip adjustment range		0.1...0.16	
Rated current (I_n)	A	0.16	
Magnetic tripping		16 x I_n	
Power dissipation per pole	min	W	0.81
	max	W	2.07

Operational short-circuit current breaking capacity (I_{cs}) at AC

230V	kA	100
400V	kA	100
440V	kA	100
500V	kA	100
690V	kA	100

Maximum short-circuit current breaking capacity (I_{cu}) at AC

230V	kA	100
400V	kA	100
440V	kA	100
500V	kA	100
690V	kA	100

Tripping class

10A

IEC Utilization category

A

Operations

Mechanical life	cycles	100000
Electrical life	cycles	100000

Mechanical features

Tightening torque for terminals

min	Nm	2.5
max	Nm	3
min	lbin	22
max	lbin	26.5

Max number of wires simultaneously connectable

Nr. 2

Conductor section

AWG/Kcmil

min	16
max	8

Flexible w/o lug conductor section	min	mm ²	1
	max	mm ²	10
Flexible c/w lug conductor section	min	mm ²	1
	max	mm ²	10
Flexible with insulated spade lug conductor section	min	mm ²	1
	max	mm ²	10
Screwdriver			PH2
Power terminal protection according to IEC/EN 60529			IP20 on front
Cable stripping length	main circuit	mm	12
Ambient conditions			
Temperature			
Operating temperature	min	°C	-20
	max	°C	+60
Storage temperature	min	°C	-50
	max	°C	+80
Compensation temperature	min	°C	-20
	max	°C	+50
Max altitude		m	3000
Operating position	normal allowable		Vertical plan Any
Fixing			Screw / DIN rail 35mm
Weight		g	270
UL technical data			
Motor Disconnect	at 480V protection	kA	65 Fuse or CB
Group Motor Installation	at 480V protection	kA	65 Fuse or CB
Tap Conductor Protection	at 480Y/277V	kA	65
Maximum UL/CSA horsepower ratings single-phase	110V-120V	HP	-
	220V-240V	HP	-
Maximum UL/CSA horsepower ratings three-phase, 3-pole	200V-208V	HP	-
	220V-240V	HP	-
	440V-480V	HP	-
Dimensions			

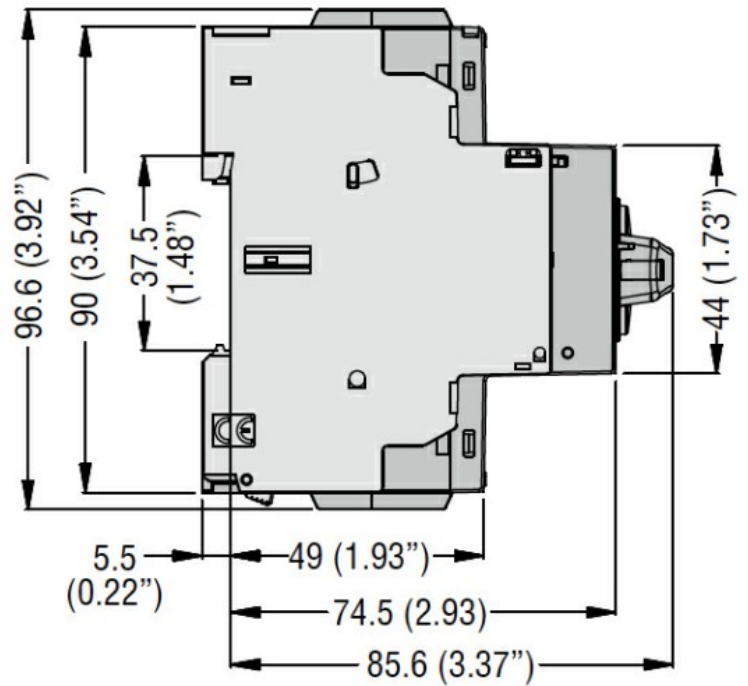
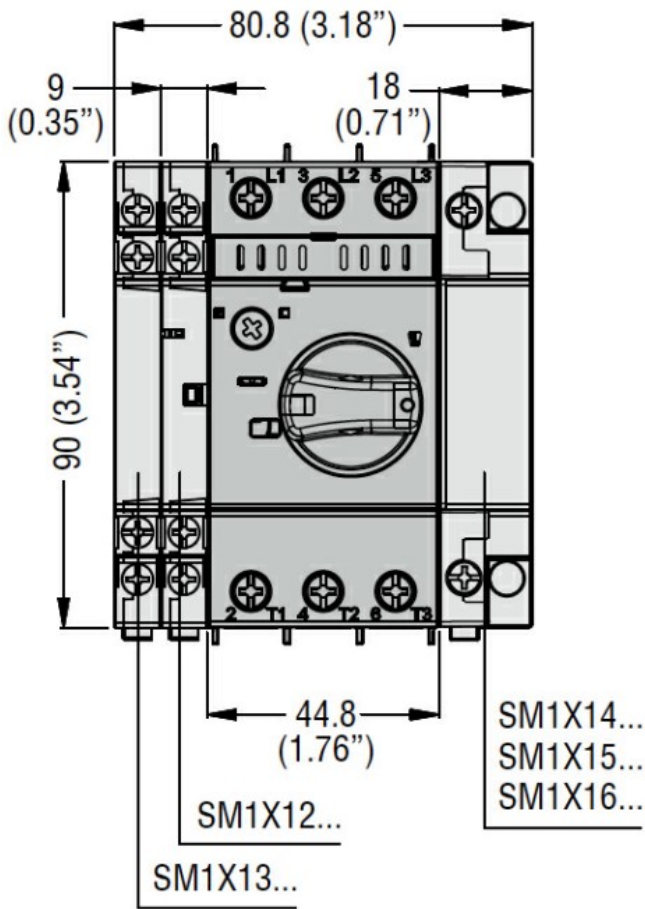

Wiring diagrams

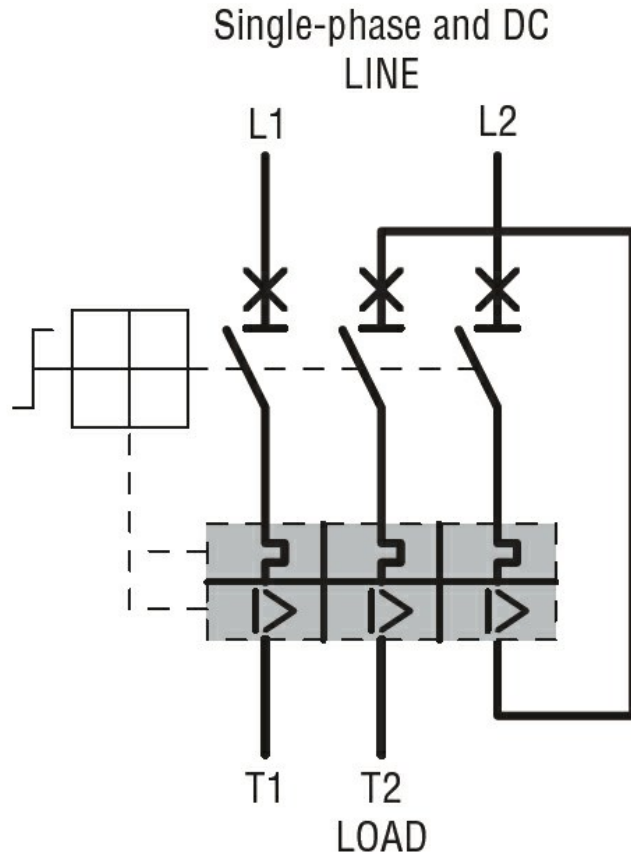
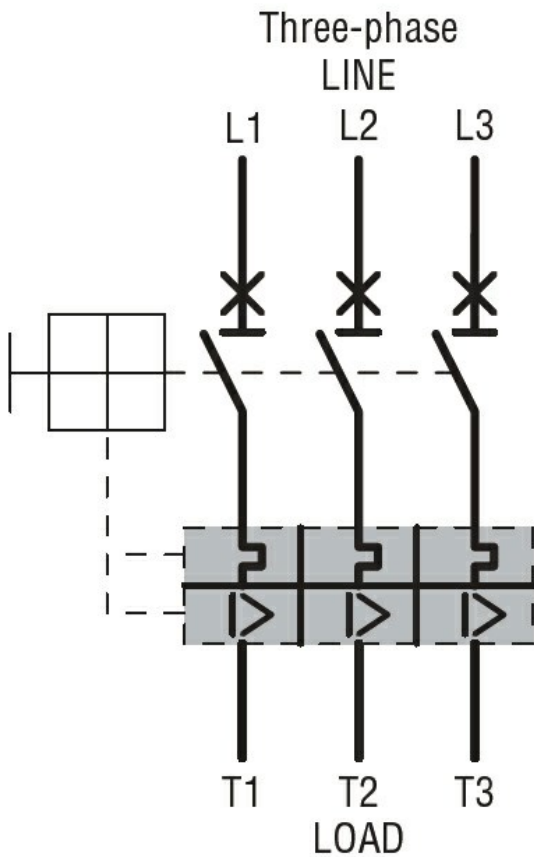

Certifications and compliance

Certifications

CSA C22.2 n° 60947-1

CSA C22.2 n° 60947-4-1

IEC/EN/BS 60947-1

IEC/EN/BS 60947-2

IEC/EN/BS 60947-4-1

UL 60947-4-1

Compliance

cULus

EAC

ETIM classification

ETIM 8.0

EC000074 -
Motor protection
circuit-breaker