



# CLV620-0830

CLV62x

FIXED MOUNT BARCODE SCANNERS

**SICK**  
Sensor Intelligence.



### Ordering information

Type	Part no.
CLV620-0830	1050940

Other models and accessories → [www.sick.com/CLV62x](http://www.sick.com/CLV62x)



### Detailed technical data

#### Features

<b>Version</b>	Mid Range
<b>Connection type</b>	Ethernet
<b>Reading field</b>	Front
<b>Sensor type</b>	Line scanner
<b>Optical focus</b>	Fixed focus
<b>Light source</b>	Light spot, laser, Visible, Red, 655 nm
<b>Laser class</b>	2 (IEC 60825-1:2014, EN 60825-1:2014)
<b>Aperture angle</b>	≤ 50°
<b>Reading distance</b>	60 mm ... 365 mm <sup>1)</sup>
<b>Scanning frequency</b>	400 Hz ... 1,200 Hz
<b>Code resolution</b>	0.2 mm ... 1 mm

<sup>1)</sup> For details see reading field diagram.

#### Mechanics/electronics

<b>Connection type</b>	2 x M12 cylindrical connectors (1 x 17-pin male connector, 4-pin female connector) on swivel connector
<b>Supply voltage</b>	10 V DC ... 30 V DC
<b>Power consumption</b>	4.5 W
<b>Housing</b>	Aluminum die cast
<b>Housing color</b>	Light blue (RAL 5012)
<b>Window material</b>	Glass
<b>Enclosure rating</b>	IP65 (DIN 40 050)
<b>Protection class</b>	III (VDE 0106/IEC 1010-1)

<sup>1)</sup> Swivel connector is 15 mm longer.

<sup>2)</sup> At 25 °C.

<b>Weight</b>	205 g, without connecting cable
<b>Dimensions (L x W x H)</b>	61 mm x 66 mm x 38 mm <sup>1)</sup>
<b>MTBF</b>	100,000 h
<b>MTTF</b>	40,000 h (Laser diode) <sup>2)</sup>

<sup>1)</sup> Swivel connector is 15 mm longer.

<sup>2)</sup> At 25 °C.

## Performance

<b>Readable code structures</b>	1D codes
<b>Bar code types</b>	All current code types
<b>Code printing process</b>	Label (printed codes)
<b>Print ratio</b>	2:1 ... 3:1
<b>No. of codes per scan</b>	1 ... 20 (Standard decoder) 1 ... 6 (SMART620)
<b>No. of codes per reading interval</b>	1 ... 50 (auto-discriminating)
<b>No. of characters per reading interval</b>	1,500 500 (for multiplexer function in CAN operation)
<b>No. of multiple readings</b>	1 ... 99

## Interfaces

<b>Ethernet</b>	✓, TCP/IP, RS-232, RS-422, RS-485
Type of fieldbus integration	Optional over external fieldbus module CDF600 Optional over external fieldbus module CDF600-2
Function	Data interface (read result output), Service interface PROFINET Single Port, PROFINET Dual Port (optional via external connection module CDF600-2) Data interface (read result output), Service interface SICK CAN sensor network CSN (CAN controller/CAN device, multiplexer/server)
Data transmission rate	10/100 MBit/s 10/100 MBit/s 10/100 MBit/s 2,400 Baud ... 115.2 kBaud, AUX: 57.6 kBaud (RS-232) 20 kbit/s ... 1 Mbit/s 20 kbit/s ... 1 Mbit/s
<b>Digital inputs</b>	4 ("Sensor 1", "Sensor 2", 2 inputs via optional parameter storage CMC600 in CDB620/CDM420)
<b>Digital outputs</b>	4 ("Result 1", "Result 2", 2 outputs via optional parameter storage CMC600 in CDB620/CDM420)
<b>Reading pulse</b>	Digital inputs
<b>Optical indicators</b>	6 LEDs (Ready, Result, laser, Data, CAN, LNK TX)
<b>Acoustic indicators</b>	Beeper/buzzer (can be switched off, can be allocated as a result indication function)
<b>Configuration software</b>	SOPAS ET

## Ambient data

<b>Electromagnetic compatibility (EMC)</b>	EN 61000-6-3 (2001-10) / EN 61000-6-2:2005
<b>Vibration resistance</b>	EN 60068-2-6 (1995)
<b>Shock resistance</b>	EN 60068-2-27 (1993)
<b>Ambient operating temperature</b>	0 °C ... +40 °C
<b>Storage temperature</b>	-20 °C ... +70 °C

<b>Permissible relative humidity</b>	90 %, Non-condensing
<b>Ambient light immunity</b>	2,000 lx, on barcode
<b>Bar code print contrast (PCS)</b>	≥ 60 %

Classifications

<b>ECLASS 5.0</b>	27280102
<b>ECLASS 5.1.4</b>	27280102
<b>ECLASS 6.0</b>	27280102
<b>ECLASS 6.2</b>	27280102
<b>ECLASS 7.0</b>	27280102
<b>ECLASS 8.0</b>	27280102
<b>ECLASS 8.1</b>	27280102
<b>ECLASS 9.0</b>	27280102
<b>ECLASS 10.0</b>	27280102
<b>ECLASS 11.0</b>	27280102
<b>ECLASS 12.0</b>	27280102
<b>ETIM 5.0</b>	EC002550
<b>ETIM 6.0</b>	EC002550
<b>ETIM 7.0</b>	EC002550
<b>ETIM 8.0</b>	EC002550
<b>UNSPSC 16.0901</b>	43211701

Dimensional drawing (Dimensions in mm (inch))

CLV62x Ethernet, front

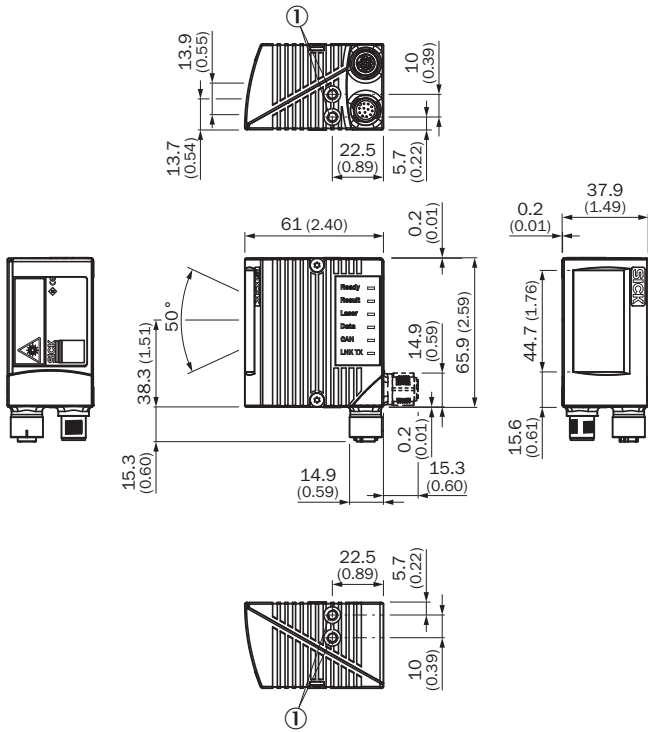

① M5

Reading field diagram

Reading field height in mm (inch)

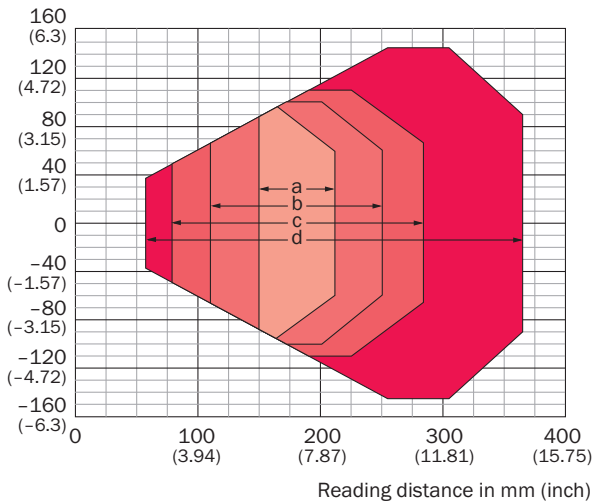





For devices with plastic reading window, the depth of field is reduced by approx. 10 %.

Resolution

- a: 0.2 mm (7.9 mil)
- b: 0.35 mm (13.8 mil)
- c: 0.50 mm (19.7 mil)
- d: 1.00 mm (39.4 mil)

Recommended accessories

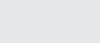
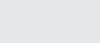
Other models and accessories → [www.sick.com/CLV62x](http://www.sick.com/CLV62x)

	Brief description	Type	Part no.
<b>Cloning modules</b>			
	External parameter memory for integration in CDB620/CDB650/CDM42x	CMC600-101	1042259
<b>Mounting brackets and plates</b>			
	Bracket with adapter board	Mounting bracket	2042902
<b>Plug connectors and cables</b>			
	<ul style="list-style-type: none"> <li>• <b>Connection type head A:</b> Male connector, M12, 4-pin, straight, D-coded</li> <li>• <b>Connection type head B:</b> Male connector, M12, 4-pin, straight, D-coded</li> <li>• <b>Signal type:</b> Ethernet, PROFINET</li> <li>• <b>Cable:</b> 2 m, 4-wire, PUR, halogen-free</li> <li>• <b>Description:</b> Ethernet, PROFINET, shielded</li> <li>• <b>Application:</b> Drag chain operation, Zones with oils and lubricants</li> </ul>	YM2D24-020PN1M2D24	2106159
	<ul style="list-style-type: none"> <li>• <b>Connection type head A:</b> Male connector, M12, 4-pin, straight, D-coded</li> <li>• <b>Connection type head B:</b> Male connector, RJ45, 4-pin, straight</li> <li>• <b>Signal type:</b> Ethernet, PROFINET</li> <li>• <b>Cable:</b> 2 m, 4-wire, PUR, halogen-free</li> <li>• <b>Description:</b> Ethernet, PROFINET, shielded</li> <li>• <b>Application:</b> Drag chain operation, Zones with oils and lubricants</li> </ul>	YM2D24-020PN1MRJA4	2106182
	<ul style="list-style-type: none"> <li>• <b>Connection type head A:</b> Male connector, M12, 4-pin, straight, D-coded</li> <li>• <b>Connection type head B:</b> Male connector, M12, 4-pin, straight, D-coded</li> <li>• <b>Signal type:</b> Ethernet, PROFINET</li> <li>• <b>Cable:</b> 3 m, 4-wire, PUR, halogen-free</li> <li>• <b>Description:</b> Ethernet, PROFINET, shielded</li> <li>• <b>Application:</b> Drag chain operation, Zones with oils and lubricants</li> </ul>	YM2D24-030PN1M2D24	2113266
	<ul style="list-style-type: none"> <li>• <b>Connection type head A:</b> Male connector, M12, 4-pin, straight, D-coded</li> <li>• <b>Connection type head B:</b> Male connector, M12, 4-pin, straight, D-coded</li> <li>• <b>Signal type:</b> Ethernet, PROFINET</li> <li>• <b>Cable:</b> 5 m, 4-wire, PUR, halogen-free</li> <li>• <b>Description:</b> Ethernet, PROFINET, shielded</li> <li>• <b>Application:</b> Drag chain operation, Zones with oils and lubricants</li> </ul>	YM2D24-050PN1M2D24	2106160
	<ul style="list-style-type: none"> <li>• <b>Connection type head A:</b> Male connector, M12, 4-pin, straight, D-coded</li> <li>• <b>Connection type head B:</b> Male connector, M12, 4-pin, straight, D-coded</li> <li>• <b>Signal type:</b> Ethernet, PROFINET</li> <li>• <b>Cable:</b> 10 m, 4-wire, PUR, halogen-free</li> <li>• <b>Description:</b> Ethernet, PROFINET, shielded</li> <li>• <b>Application:</b> Drag chain operation, Zones with oils and lubricants</li> </ul>	YM2D24-100PN1M2D24	2106161
<b>Modules</b>			
	<ul style="list-style-type: none"> <li>• <b>Sub product family:</b> CDB620</li> <li>• <b>Supported products:</b> CLV61x - CLV65x, Lector62x, RFH6xx, RFU62x</li> <li>• <b>Brief description:</b> Small connection module for one sensor, 4 cable glands, base for CMC600</li> </ul>	CDB620-001	1042256

## Recommended services

Additional services → [www.sick.com/CLV62x](http://www.sick.com/CLV62x)

	Type	Part no.
Performance check		
<ul style="list-style-type: none"> <li>• <b>Product area:</b> Fixed mount barcode scanners</li> <li>• <b>Range of services:</b> Inspection of defined functions, e.g., reading performance</li> <li>• <b>Travel expenses:</b> The prices do not include travel costs such as hotel, flight, travel time and expenses.</li> <li>• <b>Duration:</b> Additional work will be invoiced separately</li> </ul>	Performance check CLV4xx/CLV6xx	1682028
Commissioning		
<ul style="list-style-type: none"> <li>• <b>Product area:</b> Fixed mount barcode scanners</li> <li>• <b>Range of services:</b> Inspection of connection, fine adjustment, optimization of parameters of SICK product as well as tests, Setup of previously defined functions of reading configuration, code configuration, data processing and network, interfaces or inputs and outputs</li> <li>• <b>Travel expenses:</b> The prices do not include travel costs such as hotel, flight, travel time and expenses.</li> <li>• <b>Duration:</b> Additional work will be invoiced separately</li> </ul>	Commissioning CLV61x ... CLV64x	1681925
Extended warranty		
<ul style="list-style-type: none"> <li>• <b>Product area:</b> Identification solutions, machine vision, Detection and ranging solutions, safety camera sensors, Safety laser scanners, Safety radar sensors</li> <li>• <b>Range of services:</b> The services correspond to the scope of the statutory manufacturer warranty (SICK general terms of delivery).</li> <li>• <b>Duration:</b> Five-year warranty from delivery date.</li> </ul>	Extended warranty for a total of five years from delivery date	1680671

## SICK AT A GLANCE

SICK is one of the leading manufacturers of intelligent sensors and sensor solutions for industrial applications. A unique range of products and services creates the perfect basis for controlling processes securely and efficiently, protecting individuals from accidents and preventing damage to the environment.

We have extensive experience in a wide range of industries and understand their processes and requirements. With intelligent sensors, we can deliver exactly what our customers need. In application centers in Europe, Asia and North America, system solutions are tested and optimized in accordance with customer specifications. All this makes us a reliable supplier and development partner.

Comprehensive services complete our offering: SICK LifeTime Services provide support throughout the machine life cycle and ensure safety and productivity.

For us, that is “Sensor Intelligence.”

## WORLDWIDE PRESENCE:

Contacts and other locations –[www.sick.com](http://www.sick.com)