

BTL70-10000

**SICK**  
Sensor Intelligence.



## Ordering information

Type	Part no.
BTL70-10000	6078489

Magnetic tape for STL/ETL70

Other models and accessories → [www.sick.com/](http://www.sick.com/)

## Detailed technical data

### Technical specifications

<b>Accessory group</b>	Magnets
<b>Description</b>	Magnetic tape length: 10.08 m, magnetic tape width: 10 mm, magnetic tape material: 17410 hard ferrite 9/28 P, substrate tape material: steel, period length 2 mm, operating temperature range: -20 °C ... 100 °C, storage temperature range: -30 °C ... 100 °C, temperature coefficient: (11 ± 1) µm/K/m
<b>Material</b>	Covering tape: V2A, magnetic tape: 17410 hard ferrite 9/28 P, substrate tape: spring steel (11± 1) µm/K/m
<b>Temperature resistance min ... max:</b>	-20 °C ... +100 °C
<b>Dimensions (W x H x L)</b>	10 mm x 10.08 m

### Classifications

<b>eCl@ss 5.0</b>	27279209
<b>eCl@ss 5.1.4</b>	27279209
<b>eCl@ss 6.0</b>	27279209
<b>eCl@ss 6.2</b>	27279209
<b>eCl@ss 7.0</b>	27279209
<b>eCl@ss 8.0</b>	27279209
<b>eCl@ss 8.1</b>	27279209
<b>eCl@ss 9.0</b>	27272492
<b>eCl@ss 10.0</b>	27272492
<b>eCl@ss 11.0</b>	27272492
<b>eCl@ss 12.0</b>	27274392
<b>ETIM 5.0</b>	EC002594
<b>ETIM 6.0</b>	EC002594
<b>ETIM 7.0</b>	EC002594
<b>ETIM 8.0</b>	EC002594
<b>UNSPSC 16.0901</b>	39122245

Dimensional drawing (Dimensions in mm (inch))

Magnetic tape

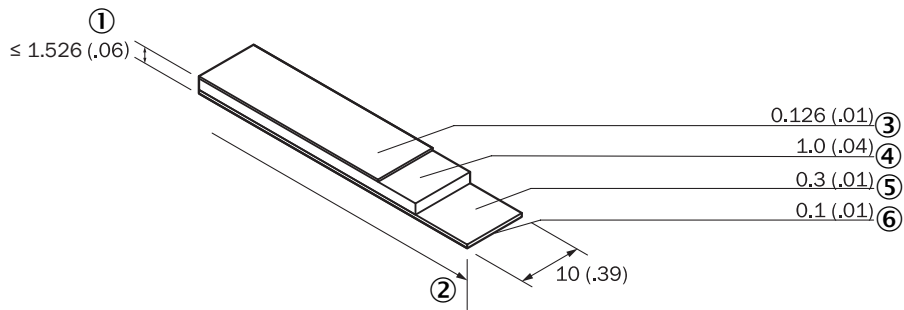

- ① Thickness
- ② Length
- ③ Minimum distance
- ④ Magnetic tape
- ⑤ Substrate tape
- ⑥ Adhesive tape

## SICK AT A GLANCE

SICK is one of the leading manufacturers of intelligent sensors and sensor solutions for industrial applications. A unique range of products and services creates the perfect basis for controlling processes securely and efficiently, protecting individuals from accidents and preventing damage to the environment.

We have extensive experience in a wide range of industries and understand their processes and requirements. With intelligent sensors, we can deliver exactly what our customers need. In application centers in Europe, Asia and North America, system solutions are tested and optimized in accordance with customer specifications. All this makes us a reliable supplier and development partner.

Comprehensive services complete our offering: SICK LifeTime Services provide support throughout the machine life cycle and ensure safety and productivity.

For us, that is “Sensor Intelligence.”

## WORLDWIDE PRESENCE:

Contacts and other locations –[www.sick.com](http://www.sick.com)