



HLG2-050E811

HLG

SWITCHING AUTOMATION LIGHT GRIDS

SICK
Sensor Intelligence.



Illustration may differ



Ordering information

Type	Part no.
HLG2-050E811	1041849

Other models and accessories → www.sick.com/HLG

Detailed technical data

Features

Sensor principle	Sender/receiver
Minimum detectable object (MDO)	Parallel beam, 2 mm
Beam separation	2 mm
Number of beams	26
Detection height	50 mm

Mechanics/electronics

Wave length	950 nm
Supply voltage V_s	DC 15 V ... 30 V ¹⁾
Power consumption sender	56.3 mA ²⁾
Power consumption receiver	125.2 mA ²⁾
Ripple	< 5 V _{pp}
Output current I_{max}	≤ 100 mA
Output load, capacitive	100 nF
Output load, Inductive	1 H
Initialization time	0.8 s
Switching output	2 x NPN ³⁾
Output mode	Q dark switching ⁴⁾
Teach-in input	PNP
Dimensions (W x H x D)	34 mm x 123 mm x 29 mm
Connection type	Male connector M12, 8-pin
Housing material	Aluminum

¹⁾ Typical value.

²⁾ , Typical value.

³⁾ Q / \bar{Q} .

⁴⁾ Q = active, if at least one beam is interrupted, /Q = active, if all of the beams are free.

Indication	LED
Synchronization	Cable
Enclosure rating	IP54
Circuit protection	U _V connections, reverse polarity protected Output Q short-circuit protected Interference pulse suppression
Protection class	III
Weight	135 g
Front screen	PMMA

¹⁾ Typical value.

²⁾ , Typical value.

³⁾ Q / \bar{Q} .

⁴⁾ Q = active, if at least one beam is interrupted, /Q = active, if all of the beams are free.

Performance

Maximum range	2 m
Minimum range	≥ 0 mm
Operating range	1.5 m
Response time	Parallel beam, 3 ms ¹⁾

¹⁾ With resistive load.

Ambient data

Shock resistance	10 g / DIN EN 60068-2-29 / 16 ms
Vibration resistance	5 g, 10 Hz ... 55 Hz (IEC 68-2-6)
EMC	EN 60947-5-2
Ambient light immunity	Indirect: ≤ 50,000 lx ¹⁾
Ambient operating temperature	-25 °C ... +55 °C
Ambient temperature, storage	-40 °C ... +70 °C

¹⁾ Sunlight.

Classifications

ECLASS 5.0	27270910
ECLASS 5.1.4	27270910
ECLASS 6.0	27270910
ECLASS 6.2	27270910
ECLASS 7.0	27270910
ECLASS 8.0	27270910
ECLASS 8.1	27270910
ECLASS 9.0	27270910
ECLASS 10.0	27270910
ECLASS 11.0	27270910
ECLASS 12.0	27270910
ETIM 5.0	EC002549
ETIM 6.0	EC002549

ETIM 7.0	EC002549
ETIM 8.0	EC002549
UNSPSC 16.0901	39121528

Dimensional drawing (Dimensions in mm (inch))

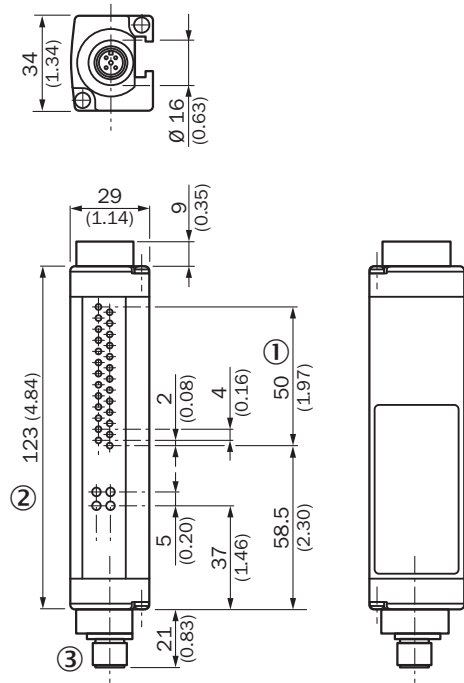

- ① Detection height: 50 mm
- ② Status indicator/power on
- ③ Male connector M12, 8-pin

Adjustments

Setting options, receiver

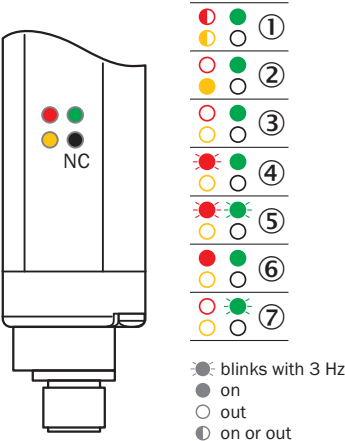

- ① Supply voltage
- ② No object in the light path
- ③ Object in the light path
- ④ Sync error
- ⑤ Weak received signal during teach-in
- ⑥ Device error
- ⑦ Teach-in process active

Connection type and diagram

Connection type and diagram

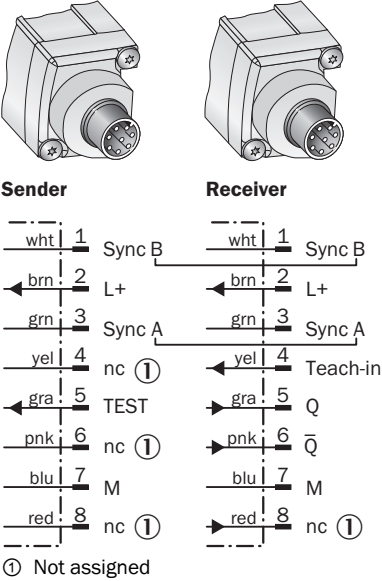

Diagramm



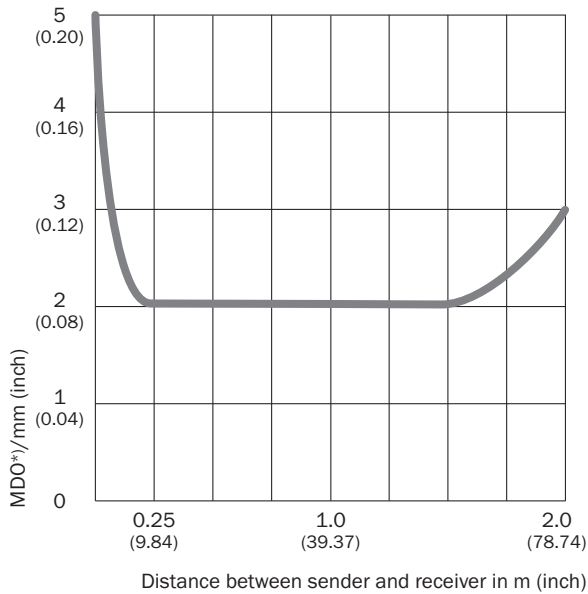

Characteristic curve: MDO



*) MDO: Minimum detectable object size measured in a direction parallel to the HLG

Recommended accessories

Other models and accessories → www.sick.com/HLG

	Brief description	Type	Part no.
Optics cloths			
	Cloth for cleaning optical surfaces	Lens cloth	4003353
Distributors			
	<ul style="list-style-type: none"> Connection type head A: Female connector, M12, 8-pin, A-coded Connection type head B: Female connector, M12, 8-pin, A-coded Connection type head C: Male connector, M12, 8-pin, A-coded Note: Male connector M12, 8-pin, straight, to 1 x female connector M12, 8-pin, straight and 1 x female connector M12, 8-pin, straight 	SBO-02F12-SM	6029306
Terminal and alignment brackets			
	4 pieces, Mounting kit 1, rotatable, swivel mount, plastic	BEF-2SMKEAKU4	2019649
Others			
	<ul style="list-style-type: none"> Connection type head A: Female connector, M12, 8-pin, straight, A-coded Connection type head B: Male connector, M12, 8-pin, straight, A-coded Signal type: Sensor/actuator cable Cable: 1 m, 8-wire, PUR, halogen-free Description: Sensor/actuator cable, shielded Application: Zones with oils and lubricants, Drag chain operation 	YF2A28-010UA6M2A28	2096108

	Brief description	Type	Part no.
	<ul style="list-style-type: none"> • Connection type head A: Female connector, M12, 8-pin, straight, A-coded • Connection type head B: Flying leads • Signal type: Sensor/actuator cable • Cable: 5 m, 8-wire, PVC • Description: Sensor/actuator cable, shielded • Application: Zones with chemicals 	<p>YF2A28-050VA6XLEAX</p>	<p>2096244</p>

SICK AT A GLANCE

SICK is one of the leading manufacturers of intelligent sensors and sensor solutions for industrial applications. A unique range of products and services creates the perfect basis for controlling processes securely and efficiently, protecting individuals from accidents and preventing damage to the environment.

We have extensive experience in a wide range of industries and understand their processes and requirements. With intelligent sensors, we can deliver exactly what our customers need. In application centers in Europe, Asia and North America, system solutions are tested and optimized in accordance with customer specifications. All this makes us a reliable supplier and development partner.

Comprehensive services complete our offering: SICK LifeTime Services provide support throughout the machine life cycle and ensure safety and productivity.

For us, that is “Sensor Intelligence.”

WORLDWIDE PRESENCE:

Contacts and other locations –www.sick.com