



Multifunction
voltage and
frequency
monitoring relays
with NFC
technology
PMV95N

Product designation

Product type designation

General characteristics

Description

Minimum and
maximum AC
voltage, minimum
and maximum
frequency, phase
loss, neutral loss,
incorrect phase
sequence and
asymmetry relay

Type of system

Three-phase
with/without
neutral

Power supply

Auxiliary supply voltage U_s Self powered

Operating voltage range 0.7...1.2 U_e

Rated frequency Hz 50/60 $\pm 5\%$

Power consumption Max VA 30

Power dissipation Max W 2.5

Control circuit

Rated voltage to control (U_e)

min VAC 380

Max VAC 575

Voltage set-point ($\%U_e$)

min % 80...95

Max % 105...115

Asymmetry set-point ($\%U_e$)

% 5...15

Frequency set-point ($\%$ rated frequency)

min % 90...99

Max % 101...110

Tripping delay

s 0.1...30

Resetting time

s 0.1...30

Resetting hysteresis

% 1...5

Instantaneous tripping for U_e

Voltage $< 70\% U_e$

Type of reset

Automatic or
manual

Repeat accuracy

% $< \pm 0.1$

Relay outputs

Number of relays

Nr. 1

Relay state	Normally energised De-energises at tripping		
Contact arrangement	1 changeover SPDT		
Rated operational voltage AC (IEC)	VAC	250	
Maximum switching voltage	VAC	400	
IEC Conventional free air thermal current Ith	A	8	
UL/CSA and IEC/EN 60947-5-1 designation	B300		
Electrical life (with rated load)	cycles	100000	
Mechanical life	cycles	30000000	

Functions

Modular version	2U		
Minimum AC voltage	Yes		
Maximum AC voltage	Yes		
Natural loss	Yes		
Phase loss	Yes		
Incorrect phase sequence	Yes		
Asymmetry	Yes		
Minimum frequency	Yes		
Maximum frequency	Yes		
Programmable via NFC technology and APP	Yes		

Indications

Indication	1 green LED for power and 5 red LEDs for tripping		
------------	---	--	--

Connections

Terminals type	Screw		
Tightening torque for terminals	max	Nm	0.8
	max	Ibin	7
Conductor cross section			
AWG/Kcmil	min	AWG	24
	Max	AWG	12
IEC	min	mm ²	0.2
	Max	mm ²	4

Insulations

Rated insulation voltage Ui	V	600	
Rated impulse withstand voltage Uimp	kV	6	
Operating frequency withstand voltage	kV	4	

Ambient conditions

Temperature			
Operating temperature	min	°C	-20
	max	°C	+60
Storage temperature	min	°C	-30
	max	°C	+80

Housing

Execution (n° of modules)	2		
---------------------------	---	--	--

Material	Self-extinguishing polyamide	
Mounting	35mm DIN rail (IEC/EN 60715)	
IEC degree of protection	IP40 on front; IP20 at terminals	
Dimensions (W x H x D)	mm	35.8 x 104.7 x 64.9
Weight	g	130

Dimensions

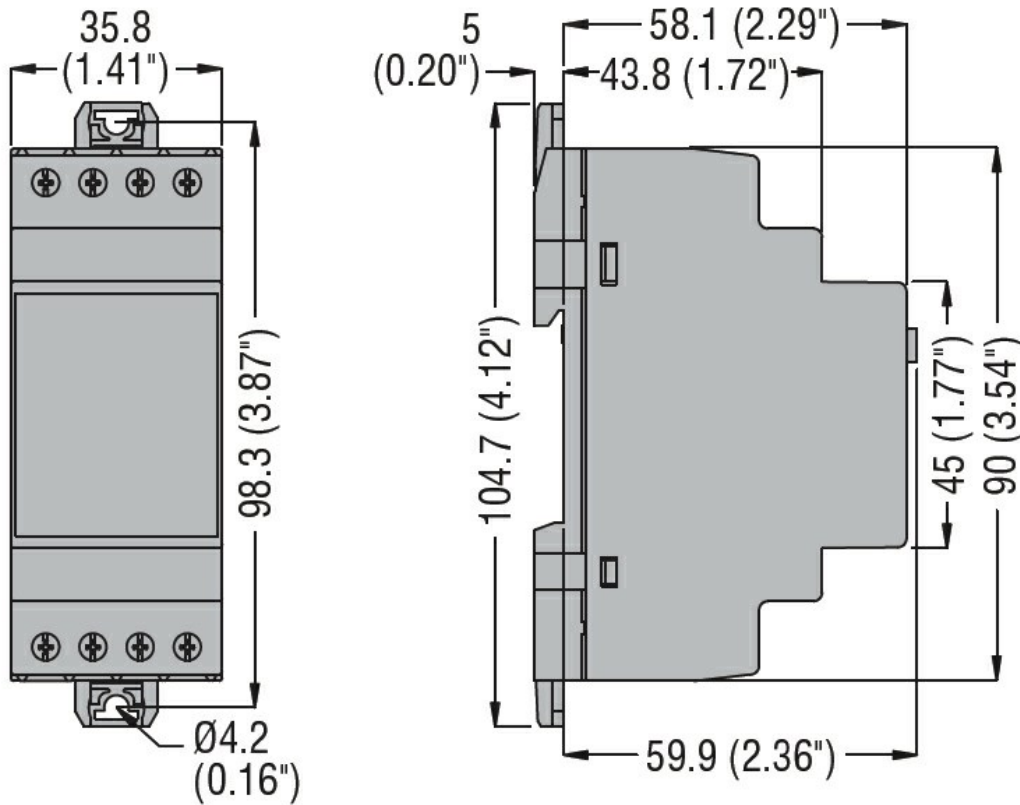

Wiring diagrams

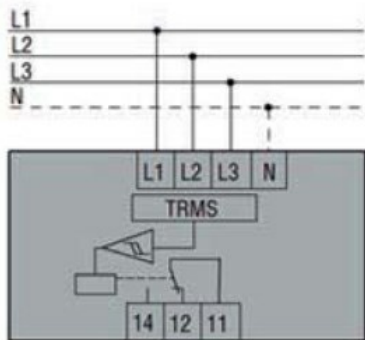

Certifications and compliance

Compliance

CSA C22.2 n°14
IEC/EN 60255-26
IEC/EN 60255-27
UL508

Certificates

cULus
EAC

ETIM classification

ETIM 8.0

EC001438 -
Voltage
monitoring relay