

YM2A8D-050XXXF2A8D

Sensor/actuator cable

PLUG CONNECTORS AND CABLES

SICK
Sensor Intelligence.

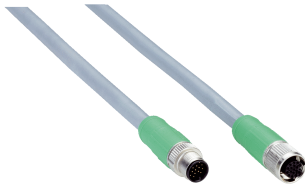

Ordering information

Type	Part no.
YM2A8D-050XXXF2A8D	6051195

Other models and accessories → www.sick.com/Sensor_actuator_cable

Detailed technical data

Technical specifications

Connection type head A	Female connector, M12, 17-pin, straight, A-coded						
Connection type head B	Male connector, M12, 17-pin, straight, A-coded						
Locking plug connector	Quick screw connection						
Cable	5 m, 17-wire						
Cable diameter	9.1 mm						
Shielding	Shielded						
Bending radius	<table border="0"> <tr> <td>Flexible use</td> <td>> 10 x cable diameter</td> </tr> <tr> <td>Stationary position</td> <td>> 5 x cable diameter</td> </tr> <tr> <td>Drag chain operation</td> <td>> 10 x cable diameter</td> </tr> </table>	Flexible use	> 10 x cable diameter	Stationary position	> 5 x cable diameter	Drag chain operation	> 10 x cable diameter
Flexible use	> 10 x cable diameter						
Stationary position	> 5 x cable diameter						
Drag chain operation	> 10 x cable diameter						
Bending cycles	1,000,000						
Signal type	Power, serial, CAN, digital I/Os						
Special feature	Suitable for 2 A						
Application	Drag chain operation						
Enclosure rating	IP68						
Description	To connection module CDB650						
Operating temperature	<table border="0"> <tr> <td>Flexible use</td> <td>-25 °C ... +80 °C</td> </tr> <tr> <td>Stationary position</td> <td>-40 °C ... +80 °C</td> </tr> </table>	Flexible use	-25 °C ... +80 °C	Stationary position	-40 °C ... +80 °C		
Flexible use	-25 °C ... +80 °C						
Stationary position	-40 °C ... +80 °C						

Classifications

ECLASS 5.0	19030312
ECLASS 5.1.4	19030312
ECLASS 6.0	27060304
ECLASS 6.2	27060304
ECLASS 7.0	27060304
ECLASS 8.0	27060304
ECLASS 8.1	27060304
ECLASS 9.0	27060304
ECLASS 10.0	27060304
ECLASS 11.0	27060304
ECLASS 12.0	27060304

ETIM 5.0	EC000830
ETIM 6.0	EC000830
ETIM 7.0	EC003249
ETIM 8.0	EC003249
UNSPSC 16.0901	26121604

PIN assignment

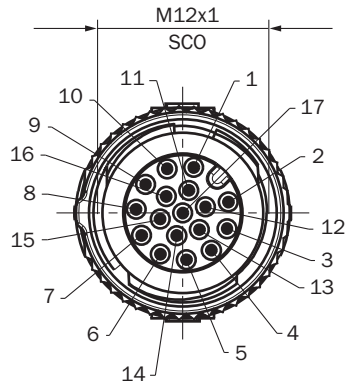

- ① Blue
- ② Brown
- ③ Green
- ④ White
- ⑤ Pink
- ⑥ Yellow
- ⑦ Black
- ⑧ Gray
- ⑨ White/black
- ⑩ Violet
- ⑪ Gray/pink
- ⑫ Red/blue
- ⑬ White/green
- ⑭ Brown/green
- ⑮ White/yellow
- ⑯ Brown/yellow
- ⑰ White/grey

SICK AT A GLANCE

SICK is one of the leading manufacturers of intelligent sensors and sensor solutions for industrial applications. A unique range of products and services creates the perfect basis for controlling processes securely and efficiently, protecting individuals from accidents and preventing damage to the environment.

We have extensive experience in a wide range of industries and understand their processes and requirements. With intelligent sensors, we can deliver exactly what our customers need. In application centers in Europe, Asia and North America, system solutions are tested and optimized in accordance with customer specifications. All this makes us a reliable supplier and development partner.

Comprehensive services complete our offering: SICK LifeTime Services provide support throughout the machine life cycle and ensure safety and productivity.

For us, that is “Sensor Intelligence.”

WORLDWIDE PRESENCE:

Contacts and other locations –www.sick.com