



Flush-mount LCD  
multimeters.  
expandable  
DMG610  
Three-phase +  
neutral

Product designation

Product type designation

Type

### Auxiliary supply Us

Auxiliary rated supply voltage AC	VAC	100...440
Auxiliary rated supply voltage DC	VDC	120...250
Auxiliary operating voltage range		
AC		
	min	VAC 90
	Max	VAC 484
DC		
	min	VDC 93.5
	Max	VDC 300

Operational frequency

min	Hz	45
max	Hz	66

Power consumption

Max	VA	9.5
-----	----	-----

Power dissipation Max

	W	3.5
--	---	-----

### Measuring voltage inputs

Rated voltage (Ue)			
	phase-phase	VAC	600
	phase-neutral	VAC	300

Operating voltage range

phase-phase	VAC	50...720
phase-neutral	VAC	30...360

Voltage inputs operational frequency

min	Hz	45
max	Hz	66

Voltage inputs measurement method

True RMS

Connection method

Single. two.  
three-phase with  
or without neutral.  
balanced three-  
phase system

### Current inputs

Rated current (Ie)	A	1A/5A
Measurement range		0.025...6A
Measurement method		TRMS
Overload capacity		+20% Ie by external CT with 5A secondary
Overload peak	A	50A for 1s

### Accuracy

VLN voltage	±0.5%
VLL voltage	±0.5%
Current	±0.5%
Frequency	±0.05%
Active power	±0.5%
Active energy	Class 1 (IEC/EN 62053-21)
Reactive energy	Class 2 (IEC/EN 62053-23)

### RS485 serial interface

Baud rate	bps	Programmable 1200...115200
-----------	-----	-------------------------------

### Insulations

Rated insulation voltage Ui IEC/EN	V	600
Rated impulse withstand voltage Uimp	kV	9.5
Operating frequency withstand voltage	kV	5.2

### Functions

Harmonic analysis	15th order
PLC logic	No
Type of communication port	RS485
Ethernet-RS485 gateway function	No

### Mechanical features

Housing type	Polyamide
Terminals type	Removable
Conductor cross section	min mm <sup>2</sup> 0.2 Max mm <sup>2</sup> 2.5 min AWG 24 Max AWG 12

Tightening torque (Max)	Nm 0.5 lbin 4.5
-------------------------	--------------------

Fixing	Flush-mounting
Weight	g 350

### Ambient conditions

Temperature	Operating temperature	min °C -20 max °C +60
-------------	-----------------------	--------------------------

Storage temperature	min °C -30 max °C +80
---------------------	--------------------------

Relative humidity	% <90
Maximum Pollution degree	2
Protection degree	IP54

### Dimensions

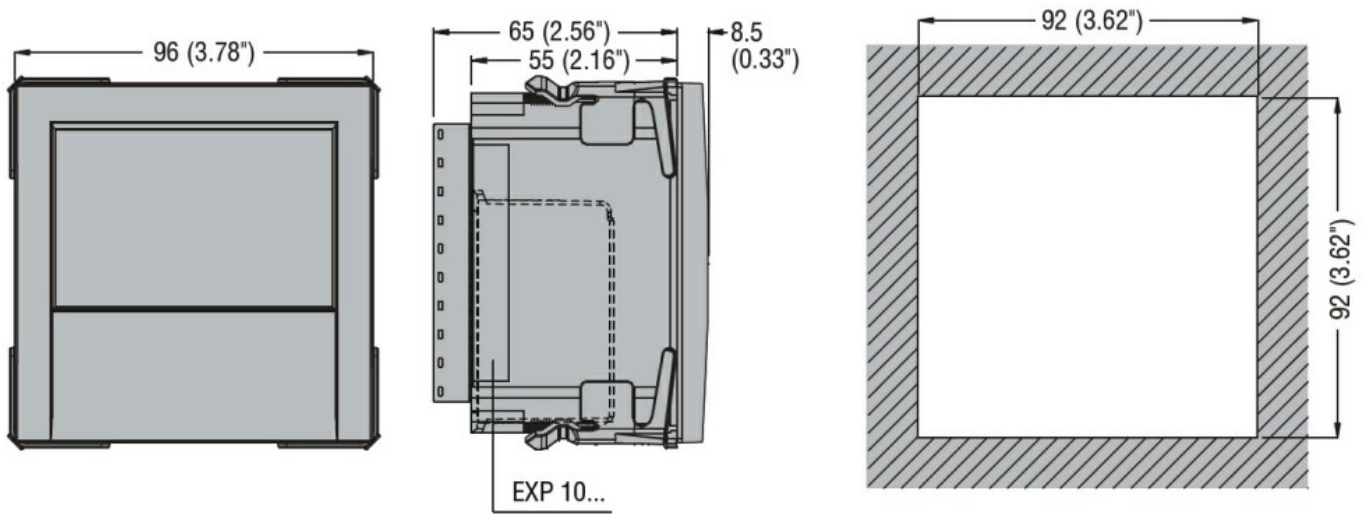

### Wiring diagrams

#### Single-phase

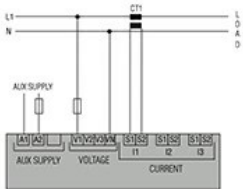

#### Two-phase

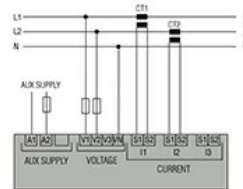

#### Three-phase with or without neutral

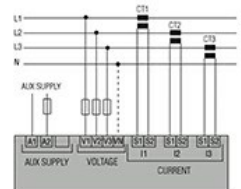

#### Three-phase without neutral in ARON connection

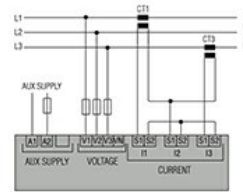
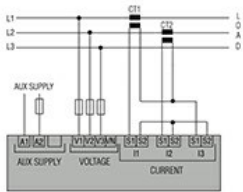

#### Balanced 3-phase connection with or without neutral

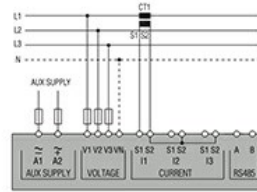

CODE	AUX SUPPLY
DMG100-110-200-210-300	100...240VAC 110...250VDC
DMG6...	100...440VAC 110...250VDC
DMG7000-7500-8000-9000	100...240VAC 110...250VDC



### Certifications and compliance

#### Compliance

CSA 22.2 n°61010-1  
IEC/EN 61000-6-2  
IEC/EN 61000-6-3  
IEC/EN 61010-1  
IEC/EN 61010-2-030  
UL61010-1

#### Certificates

cULus  
EAC  
GOST  
RCM

### ETIM classification

ETIM 8.0

EC002301 -  
Multifunction  
measuring  
instrument