



DFS60E-S1WA01024

DFS60

INCREMENTAL ENCODERS

SICK
Sensor Intelligence.



Illustration may differ



Ordering information

| Type | Part no. |
|------------------|----------|
| DFS60E-S1WA01024 | 1057689 |

Other models and accessories → www.sick.com/DFS60

Detailed technical data

Performance

| | |
|---|-------------------------------------|
| Pulses per revolution | 1,024 ¹⁾ |
| Measuring step | 90°, electric/pulses per revolution |
| Measuring step deviation at binary number of lines | ± 0.15° |
| Error limits | ± 0.3° |

¹⁾ See maximum revolution range.

Interfaces

| | |
|--|---|
| Communication interface | Incremental |
| Communication Interface detail | HTL / Push pull |
| Number of signal channels | 6-channel |
| 0-set function via hardware pin | ✓ |
| 0-SET function | H-active, L = 0 - 3 V, H = 4,0 - U _s V ¹⁾ |
| Initialization time | 30 ms |
| Output frequency | ≤ 300 kHz |
| Load current | ≤ 30 mA |
| Power consumption | ≤ 0.7 W (without load) |

¹⁾ Only with devices with M23 connector in connection with electrical interfaces M, U, V and W.

Electrical data

| | |
|---------------------------------|-------------------------------------|
| Connection type | Male connector, M23, 12-pin, radial |
| Supply voltage | 4.5 ... 32 V |
| Reference signal, number | 1 |

¹⁾ Short-circuit opposite to another channel, US or GND permissible for maximum 30 s.

²⁾ This product is a standard product and does not constitute a safety component as defined in the Machinery Directive. Calculation based on nominal load of components, average ambient temperature 40°C, frequency of use 8760 h/a. All electronic failures are considered hazardous. For more information, see document no. 8015532.

| | |
|--|---|
| Reference signal, position | 90°, electric, logically gated with A and B |
| Reverse polarity protection | ✓ |
| Short-circuit protection of the outputs | ✓ ¹⁾ |
| MTTFd: mean time to dangerous failure | 300 years (EN ISO 13849-1) ²⁾ |

¹⁾ Short-circuit opposite to another channel, US or GND permissible for maximum 30 s.

²⁾ This product is a standard product and does not constitute a safety component as defined in the Machinery Directive. Calculation based on nominal load of components, average ambient temperature 40 °C, frequency of use 8760 h/a. All electronic failures are considered hazardous. For more information, see document no. 8015532.

Mechanical data

| | |
|---------------------------------------|---|
| Mechanical design | Solid shaft, Servo flange |
| Shaft diameter | 6 mm |
| Shaft length | 10 mm |
| Weight | + 0.3 kg |
| Shaft material | Stainless steel |
| Flange material | Aluminum |
| Housing material | Aluminum die cast |
| Start up torque | 0.5 Ncm (+20 °C) |
| Operating torque | 0.3 Ncm (+20 °C) |
| Permissible shaft loading | 80 N (radial) 40 N (axial) |
| Operating speed | ≤ 9,000 min ⁻¹ ¹⁾ |
| Moment of inertia of the rotor | 6.2 gcm ² |
| Bearing lifetime | 3.6 x 10 ¹⁰ revolutions |
| Angular acceleration | ≤ 500,000 rad/s ² |

¹⁾ Allow for self-heating of 3.3 K per 1,000 rpm when designing the operating temperature range.

Ambient data

| | |
|--------------------------------------|--|
| EMC | According to EN 61000-6-2 and EN 61000-6-3 |
| Enclosure rating | IP67, Housing side, male connector (IEC 60529) ¹⁾ IP65, shaft side (IEC 60529) |
| Permissible relative humidity | 90 % (Condensation not permitted) |
| Operating temperature range | 0 °C ... +85 °C |
| Storage temperature range | -40 °C ... +100 °C, without package |
| Resistance to shocks | 50 g, 6 ms (EN 60068-2-27) |
| Resistance to vibration | 20 g, 10 Hz ... 2,000 Hz (EN 60068-2-6) |

¹⁾ With mating connector fitted.

Classifications

| | |
|---------------------|----------|
| eCl@ss 5.0 | 27270501 |
| eCl@ss 5.1.4 | 27270501 |
| eCl@ss 6.0 | 27270590 |
| eCl@ss 6.2 | 27270590 |
| eCl@ss 7.0 | 27270501 |

| | |
|-----------------------|----------|
| eCl@ss 8.0 | 27270501 |
| eCl@ss 8.1 | 27270501 |
| eCl@ss 9.0 | 27270501 |
| eCl@ss 10.0 | 27270501 |
| eCl@ss 11.0 | 27270501 |
| eCl@ss 12.0 | 27270501 |
| ETIM 5.0 | EC001486 |
| ETIM 6.0 | EC001486 |
| ETIM 7.0 | EC001486 |
| ETIM 8.0 | EC001486 |
| UNSPSC 16.0901 | 41112113 |

Dimensional drawing (Dimensions in mm (inch))

Servo flange, M12 and M23 radial male connector

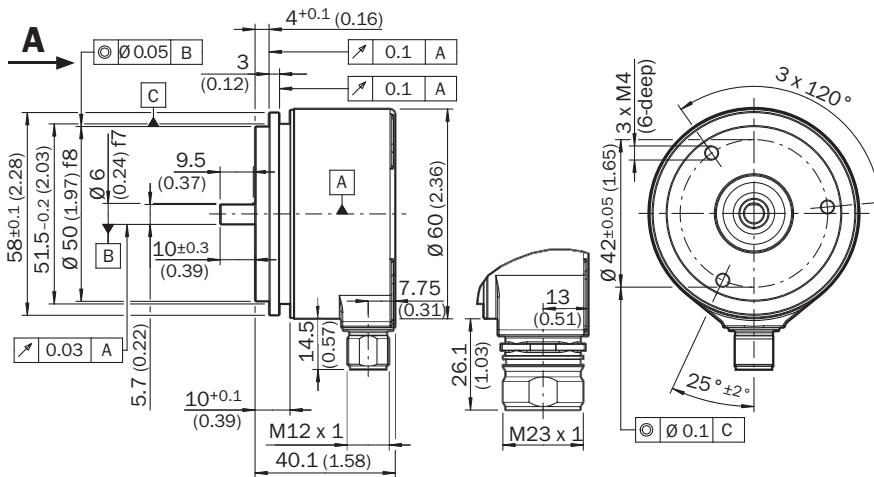

General tolerances according to DIN ISO 2768-mk

Attachment specifications

Mounting requirements for half-shell servo clamp

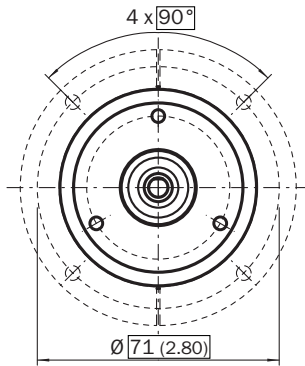

All dimensions in mm (inch)

Part no. 2029165

Mounting requirements for small servo clamp

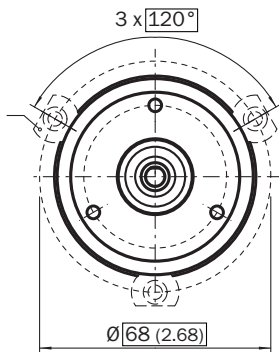

All dimensions in mm (inch)

Part no. 2029166

PIN assignment

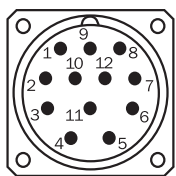

View of M23 male device connector on encoder

| PIN Male connector M12, 8-pin | PIN Male connector M23, 12-pin | Wire colors (cable connection) | TTL/HTL signal | Sin/Cos 1.0 V _{pp} | Explanation |
|----------------------------------|-----------------------------------|--------------------------------|----------------|-----------------------------|-------------|
| 1 | 6 | Brown | \bar{A} | COS- | Signal wire |
| 2 | 5 | White | A | COS+ | Signal wire |
| 3 | 1 | Black | \bar{B} | SIN- | Signal wire |
| 4 | 8 | Pink | B | SIN+ | Signal wire |
| 5 | 4 | Yellow | \bar{Z} | \bar{Z} | Signal wire |
| 6 | 3 | Purple | Z | Z | Signal wire |

| PIN Male connector M12, 8-pin | PIN Male connector M23, 12-pin | Wire colors (cable connection) | TTL/HTL signal | Sin/Cos 1.0 V _{PP} | Explanation |
|----------------------------------|-----------------------------------|--------------------------------|---------------------|-----------------------------|---|
| 7 | 10 | Blue | GND | GND | Ground connection |
| 8 | 12 | Red | +U _S | +U _S | Supply voltage |
| - | 9 | - | N.c. | N.c. | Not assigned |
| - | 2 | - | N.c. | N.c. | Not assigned |
| - | 11 | - | N.c. | N.c. | Not assigned |
| - | 7 ¹⁾ | Orange | 0-SET ¹⁾ | N.c. | Set zero pulse ¹⁾ |
| Screen | Screen | Screen | Screen | Screen | Screen connected to housing on encoder side. Connected to ground on control side. |

1)

For electrical interfaces only: M, U, V, W with 0-SET function on PIN 7 on M23 plug. The 0-SET input is used to set the zero pulse to the current shaft position. If the 0-SET input is applied to US for longer than 250 ms after it has previously been open or applied to GND for at least 1,000 ms, the current shaft position is assigned zero pulse signal "Z".

Diagrams

Signal outputs

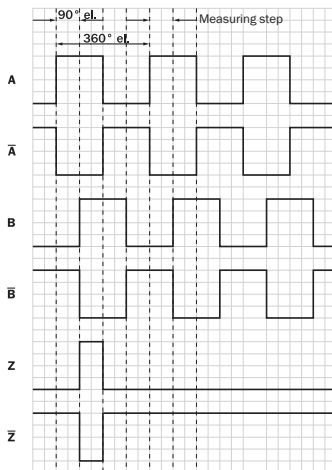

CW with view on the encoder shaft in direction "A", compare dimensional drawing.





Maximum revolution range











| Supply voltage | Output |
|-----------------|--------|
| 4,5 V ... 5,5 V | TTL |
| 10 V ... 32 V | TTL |
| 10 V ... 32 V | HTL |

Recommended accessories

Other models and accessories → www.sick.com/DFS60

| | Brief description | Type | Part no. |
|---|---|----------------|----------|
| Other mounting accessories | | | |
|  | Aluminium measuring wheel with O-ring (NBR70) for 6 mm solid shaft, circumference 200 mm | BEF-MR006020R | 2055222 |
| | Measuring wheel with O-ring (NBR70) for 6 mm solid shaft, circumference 300 mm | BEF-MR006030R | 2055634 |
| | Aluminium measuring wheel with O-ring (NBR70) for 6 mm solid shaft, circumference 500 mm | BEF-MR006050R | 2055225 |
|  | Aluminum measuring wheel with cross-knurled surface for 6 mm solid shaft, circumference 200 mm | BEF-MR06200AK | 4084745 |
|  | Aluminum measuring wheel with smooth polyurethane surface for 6 mm solid shaft, circumference 200 mm | BEF-MR06200AP | 4084746 |
|  | Aluminum measuring wheel with ridged polyurethane surface for 6 mm solid shaft, circumference 200 mm | BEF-MR06200APG | 4084748 |
|  | Aluminum measuring wheel with studded polyurethane surface for 6 mm solid shaft, circumference 200 mm | BEF-MR06200APN | 4084747 |

| | Brief description | Type | Part no. |
|---|--|------------------|----------|
|  | Mounting bell for encoder with servo flange, 50 mm spigot, mounting kit included | BEF-MG-50 | 5312987 |
|  | Bearing block for servo and face mount flange encoder. The heavy-duty bearing block is used to absorb very large radial and axial shaft loads. Particularly when using belt pulleys, chain sprockets, friction wheels. Operating speed max. 4,000 rpm ⁻¹ , axial shaft load 150 N, radial shaft load 250 N, bearing service life 3.6 x 10 ⁹ revolutions | BEF-FA-LB1210 | 2044591 |
| | Mounting kit for servo flange encoder on the bearing block, 1 bar coupling SKPS 1520 06/06 1 hexagon socket wrench SW1.5 DIN 911, 3 mounting eccentric BEMN 1242 49 3 screws M4 x 10 DIN 912, 1 hexagon socket wrench SW3 DIN 911, 1 bar coupling SKPS 1520 06/06 1 hexagon socket wrench SW1.5 DIN 911, 3 mounting eccentric BEMN 1242 49 3 screws M4 x 10 DIN 912, 1 hexagon socket wrench SW3 DIN 911 | BEF-MK-LB | 5320872 |
|  | Servo clamps, large, for servo flange (clamps, eccentric fastener), 3 pcs, without mounting material, without mounting hardware | BEF-WK-SF | 2029166 |
| Plug connectors and cables | | | |
|  | Head A: female connector, M23, 12-pin, straight Head B: Flying leads Cable: Incremental, PUR, shielded, 2 m | DOL-2312-G02MLD1 | 2062202 |
|  | Head A: female connector, M23, 12-pin, straight Head B: Flying leads Cable: Incremental, PUR, halogen-free, shielded, 3 m | DOL-2312-G03MMD1 | 2062243 |
| | Head A: female connector, M23, 12-pin, straight Head B: Flying leads Cable: Incremental, PUR, halogen-free, shielded, 5 m | DOL-2312-G05MMD1 | 2062244 |
|  | Head A: female connector, M23, 12-pin, straight Head B: Flying leads Cable: Incremental, PUR, shielded, 7 m | DOL-2312-G07MLD1 | 2062203 |
| | Head A: female connector, M23, 12-pin, straight Head B: Flying leads Cable: Incremental, PUR, shielded, 10 m | DOL-2312-G10MLD1 | 2062204 |
|  | Head A: female connector, M23, 12-pin, straight Head B: Flying leads Cable: Incremental, PUR, halogen-free, shielded, 10 m | DOL-2312-G10MMD1 | 2062245 |
|  | Head A: female connector, M23, 12-pin, straight Head B: Flying leads Cable: Incremental, PUR, shielded, 15 m | DOL-2312-G15MLD1 | 2062205 |
|  | Head A: female connector, M23, 12-pin, straight Head B: Flying leads Cable: Incremental, PUR, halogen-free, shielded, 1.5 m | DOL-2312-G1M5MD1 | 2062240 |
|  | Head A: female connector, M23, 12-pin, straight Head B: Flying leads Cable: Incremental, PUR, shielded, 20 m | DOL-2312-G20MLD1 | 2062206 |
|  | Head A: female connector, M23, 12-pin, straight Head B: Flying leads Cable: Incremental, PUR, halogen-free, shielded, 20 m | DOL-2312-G20MMD1 | 2062246 |
|  | Head A: female connector, M23, 12-pin, straight Head B: Flying leads Cable: Incremental, PUR, shielded, 25 m | DOL-2312-G25MLD1 | 2062207 |
| | Head A: female connector, M23, 12-pin, straight Head B: Flying leads Cable: Incremental, PUR, shielded, 30 m | DOL-2312-G30MLD1 | 2062208 |
|  | Head A: female connector, M23, 12-pin, straight Head B: Flying leads Cable: Incremental, PUR, halogen-free, shielded, 30 m | DOL-2312-G30MMD1 | 2062247 |

| | Brief description | Type | Part no. |
|---|---|--------------|----------|
|  | Head A: female connector, M23, 12-pin, straight Cable: HIPERFACE [®] , SSI, Incremental, shielded | DOS-2312-G02 | 2077057 |
|  | Head A: female connector, M23, 12-pin, angled Cable: HIPERFACE [®] , SSI, Incremental, shielded | DOS-2312-W01 | 2072580 |
| Shaft adaptation | | | |
|  | Bellows coupling, shaft diameter 6 mm / 6 mm, maximum shaft offset: radial ± 0.25 mm, axial ± 0.4 mm, angular $\pm 4^\circ$; max. speed 10,000 rpm, -30°C to $+120^\circ\text{C}$, max. torque 120 Ncm; material: stainless steel bellows, aluminum hub | KUP-0606-B | 5312981 |
|  | Cross-slotted coupling, shaft diameter 6 mm / 6 mm, maximum shaft offset: radial ± 0.3 mm, axial ± 0.2 mm, angle $\pm 3^\circ$; max. speed 10,000 rpm, -10° to $+80^\circ\text{C}$, max. torque 80 Ncm; material: fiber-glass reinforced polyamide, aluminum hub | KUP-0606-S | 2056406 |
| | Bar coupling, shaft diameter 6 mm / 8 mm, maximum shaft offset radial ± 0.3 mm, axial ± 0.2 mm, angle $\pm 3^\circ$, max. speed 10,000 rpm, torsion spring rigidity 38 Nm/wheel; material: fiber-glass reinforced polyamide, aluminum hub | KUP-0608-S | 5314179 |
|  | Bellows coupling, shaft diameter 6 mm / 10 mm, maximum shaft offset: radial ± 0.25 mm, axial ± 0.4 mm, angular $\pm 4^\circ$; max. speed 10,000 rpm, -30°C to $+120^\circ\text{C}$, max. torque 120 Ncm; material: stainless steel bellows, aluminum hub | KUP-0610-B | 5312982 |
|  | Double loop coupling, shaft diameter 6 mm / 10 mm, max. shaft offset: radially $\pm 2,5$ mm, axially ± 3 mm, angle ± 10 degrees; max. speed 3.000 rpm, -30 to $+80$ degrees Celsius, torsional spring stiffness of 25 Nm/rad | KUP-0610-D | 5326697 |
|  | Spring washer coupling, shaft diameter 6 mm / 10 mm, Maximum shaft offset: radial ± 0.3 mm, axial ± 0.4 mm, angular $\pm 2.5^\circ$; max. speed 12,000 rpm, -10° to $+80^\circ\text{C}$, max. torque 60 Ncm; material: aluminum flange, glass fiber-reinforced polyamide membrane and hardened steel coupling pin | KUP-0610-F | 5312985 |
|  | Claw coupling, shaft diameter 6 mm / 10 mm, damping element 80 shore blue, maximum shaft offset: radial ± 0.22 mm, axial ± 1 mm angular $\pm 1.3^\circ$, max. speed 19,000 rpm, angle of twist max. 10° , -30°C to $+80^\circ\text{C}$, max. torque 800 Ncm, tightening torque of screws: ISO 4029 150 Ncm, material: aluminum flange, damping element: polyurethane | KUP-0610-J | 2127056 |
|  | Bar coupling, shaft diameter 6 mm / 10 mm, max. shaft offset: radial $\pm 0,3$ mm, axial $\pm 0,3$ mm, angular $\pm 3^\circ$; max. speed 10.000 rpm, -10° to $+80^\circ\text{C}$, max. torque: 80 Ncm, material: fiber-glass reinforced polyamide, aluminum hub | KUP-0610-S | 2056407 |

SICK AT A GLANCE

SICK is one of the leading manufacturers of intelligent sensors and sensor solutions for industrial applications. A unique range of products and services creates the perfect basis for controlling processes securely and efficiently, protecting individuals from accidents and preventing damage to the environment.

We have extensive experience in a wide range of industries and understand their processes and requirements. With intelligent sensors, we can deliver exactly what our customers need. In application centers in Europe, Asia and North America, system solutions are tested and optimized in accordance with customer specifications. All this makes us a reliable supplier and development partner.

Comprehensive services complete our offering: SICK LifeTime Services provide support throughout the machine life cycle and ensure safety and productivity.

For us, that is “Sensor Intelligence.”

WORLDWIDE PRESENCE:

Contacts and other locations –www.sick.com