

PacT Series

ComPacT NS - MicroLogic P Trip Units

User Guide

PacT Series offers world-class breakers and switches.

DOCA0219EN-00
01/2022



Legal Information

The Schneider Electric brand and any trademarks of Schneider Electric SE and its subsidiaries referred to in this guide are the property of Schneider Electric SE or its subsidiaries. All other brands may be trademarks of their respective owners.

This guide and its content are protected under applicable copyright laws and furnished for informational use only. No part of this guide may be reproduced or transmitted in any form or by any means (electronic, mechanical, photocopying, recording, or otherwise), for any purpose, without the prior written permission of Schneider Electric.

Schneider Electric does not grant any right or license for commercial use of the guide or its content, except for a non-exclusive and personal license to consult it on an "as is" basis. Schneider Electric products and equipment should be installed, operated, serviced, and maintained only by qualified personnel.

As standards, specifications, and designs change from time to time, information contained in this guide may be subject to change without notice.

To the extent permitted by applicable law, no responsibility or liability is assumed by Schneider Electric and its subsidiaries for any errors or omissions in the informational content of this material or consequences arising out of or resulting from the use of the information contained herein.

As part of a group of responsible, inclusive companies, we are updating our communications that contain non-inclusive terminology. Until we complete this process, however, our content may still contain standardized industry terms that may be deemed inappropriate by our customers.

Table of Contents

Safety Information.....	5
About the Book.....	6
Introduction to MicroLogic P Trip Unit.....	7
Presentation.....	8
Description.....	10
LEDs and Display Screens.....	14
Go2SE Landing Page.....	17
Using the MicroLogic P Human Machine Interface.....	18
MicroLogic P HMI Description.....	19
Tree Navigation.....	20
MicroLogic P Screens.....	22
Metering Menu.....	23
History, Maintenance, and Setup Menu.....	25
Protection Menu.....	27
Setting Up the MicroLogic Functions.....	30
Setting Up the MicroLogic Trip Unit.....	31
Setting Up the Metering Functions.....	38
Setting Up the COM Communications Option.....	42
Protection Settings for MicroLogic P Trip Unit.....	46
Setting Principles.....	47
Setting the Current Protection Functions.....	50
Setting MicroLogic 5.0 P Trip Unit.....	50
Setting MicroLogic 6.0 P Trip Unit.....	52
Setting MicroLogic 7.0 P Trip Unit.....	54
Setting the Neutral Protection.....	56
Setting Additional Protection Functions.....	58
Setting Load Shedding And Reconnection Function.....	61
Protection Functions of MicroLogic P Trip Unit.....	62
Current Protection for MicroLogic P Trip Unit.....	63
Long-Time Protection.....	64
Short-Time Protection.....	67
Instantaneous Protection.....	68
Ground-Fault Protection on MicroLogic 6.0 P Trip Unit.....	70
Earth-Leakage Protection on MicroLogic 7.0 P Trip Unit.....	71
Neutral Protection.....	72
Additional Protection for MicroLogic P Trip Unit.....	74
Additional Current Protection Functions.....	74
Voltage Protection Functions.....	76
Other Protection Functions.....	78
Load Shedding and Reconnection.....	80
Other Functions of MicroLogic P Trip Unit.....	81
Measurements.....	82
Current and Voltage.....	82
Power, Energy, and Frequency.....	84
Alarms.....	86
Event Histories.....	88
Operation Counter and Contact Wear Indicator.....	89

Communication Function.....	90
Maintenance of MicroLogic Trip Unit.....	91
Viewing the Event Histories	92
Viewing the Operation Counter and Contact Wear Indicator	93
Checking and Replacing the Battery	94
Testing the Ground-Fault and Earth-Leakage Functions	96
Testing the MicroLogic P Trip Unit	97
Technical Appendix.....	98
Tripping Curves	99
Voltage Measurements	101
Long-Time Rating Plug	104
Zone Selective Interlocking (ZSI)	107
Power Supply	110
Thermal Memory	113
Threshold and Time-Delay Settings	114
Other Settings	117
Measurement Ranges and Accuracy	119
Power Factor Sign Conventions	121

Safety Information

Important Information

Read these instructions carefully, and look at the equipment to become familiar with the device before trying to install, operate, service, or maintain it. The following special messages may appear throughout this documentation or on the equipment to warn of potential hazards or to call attention to information that clarifies or simplifies a procedure.



The addition of this symbol to a “Danger” or “Warning” safety label indicates that an electrical hazard exists which will result in personal injury if the instructions are not followed.



This is the safety alert symbol. It is used to alert you to potential personal injury hazards. Obey all safety messages that follow this symbol to avoid possible injury or death.

DANGER

DANGER indicates a hazardous situation which, if not avoided, **will result in** death or serious injury.

WARNING

WARNING indicates a hazardous situation which, if not avoided, **could result in** death or serious injury.

CAUTION

CAUTION indicates a hazardous situation which, if not avoided, **could result in** minor or moderate injury.

NOTICE

NOTICE is used to address practices not related to physical injury.

Please Note

Electrical equipment should be installed, operated, serviced, and maintained only by qualified personnel. No responsibility is assumed by Schneider Electric for any consequences arising out of the use of this material.

A qualified person is one who has skills and knowledge related to the construction and operation of electrical equipment and its installation, and has received safety training to recognize and avoid the hazards involved.

About the Book

Document Scope

The aim of this guide is to provide users, installers and maintenance personnel with the technical information needed to operate MicroLogic™ P trip units in ComPacT™ NS circuit breakers.

Validity Note

This guide applies to ComPacT NS MicroLogic P trip units.

Online Information

The information contained in this guide is likely to be updated at any time. Schneider Electric strongly recommends that you have the most recent and up-to-date version available on www.se.com/ww/en/download.

The technical characteristics of the devices described in this guide also appear online. To access the information online, go to the Schneider Electric home page at www.se.com.

Related Documents

Title of documentation	Reference number
<i>ComPacT NS - Circuit Breakers and Switch-Disconnectors - User Guide</i>	DOCA0221EN
<i>ComPacT NS - Modbus Communication Guide</i>	DOCA0220EN
<i>ComPacT NS630b-1600 - Fixed Circuit Breaker or Switch-Disconnecter - Instruction Sheet</i>	JYT6180003
<i>ComPacT NS630b-1600 - Withdrawable Circuit Breaker or Switch-Disconnecter - Instruction Sheet</i>	JYT6180103
<i>ComPacT NS1600b-3200 - Fixed Circuit Breaker or Switch-Disconnecter - Instruction Sheet</i>	JYT6180203

You can download these technical publications and other technical information from our website at www.se.com/ww/en/download.

Introduction to MicroLogic P Trip Unit

What's in This Part

Presentation	8
Description	10
LEDs and Display Screens.....	14
Go2SE Landing Page	17

Presentation

PacT Series Master Range

Future-proof your installation with Schneider Electric's low-voltage and medium-voltage PacT Series. Built on legendary Schneider Electric innovation, the PacT Series comprises world-class circuit breakers, switches, residual current devices and fuses, for all standard and specific applications. Experience robust performance with PacT Series within the EcoStruxure-ready switchgear, from 16 to 6300 A in low-voltage and up to 40.5 kV in medium-voltage.

Introduction

ComPacT NS630–3200 circuit breakers are equipped with a MicroLogic trip unit designed to help protect power circuits and connected loads.

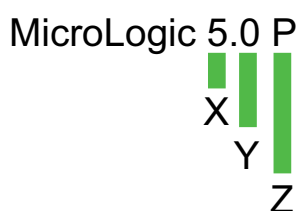

X : Type of protection

- 2 : for basic protection
- 5 : for selective selection
- 6 : for selective + ground-fault protection
- 7 : for selective + earth-leakage protection

Y : Version number

Identification of the trip unit generation (0 is the first generation.)

Z : Type of measurement

- A : Ammeter
- E : Energy meter
- P : Power meter
- No indication : No measurements

Range of MicroLogic P Trip Units

The functions provided by MicroLogic 5.0 P, 6.0 P and 7.0 P trip units optimize continuity of service and power management in your installation

The MicroLogic P trip units offer current, voltage, frequency, power and energy measurements.

The following table indicates the standard functions available on ComPacT NS circuit breakers with MicroLogic P trip units:

MicroLogic trip unit		5.0 P	6.0 P	7.0 P
Standard protection functions	Long-time overcurrent protection (L)	✓	✓	✓
	Short-time overcurrent protection (S)	✓	✓	✓
	Instantaneous overcurrent protection (I)	✓	✓	✓
	Ground-fault protection (G)	–	✓	–
	Earth-leakage protection (E)	–	–	✓
	Neutral protection on 4P circuit breaker	✓	✓	✓
	Overload LED	✓	✓	✓

MicroLogic trip unit		5.0 P	6.0 P	7.0 P
	Trip cause indicators	✓	✓	✓
Additional protection functions	Current unbalance	✓	✓	✓
	Voltage unbalance	✓	✓	✓
	Undervoltage protection	✓	✓	✓
	Overvoltage protection	✓	✓	✓
	Reverse active power protection	✓	✓	✓
	Underfrequency protection	✓	✓	✓
	Overfrequency protection	✓	✓	✓
Additional control functions	Load shedding and reconnection	✓	✓	✓

Description

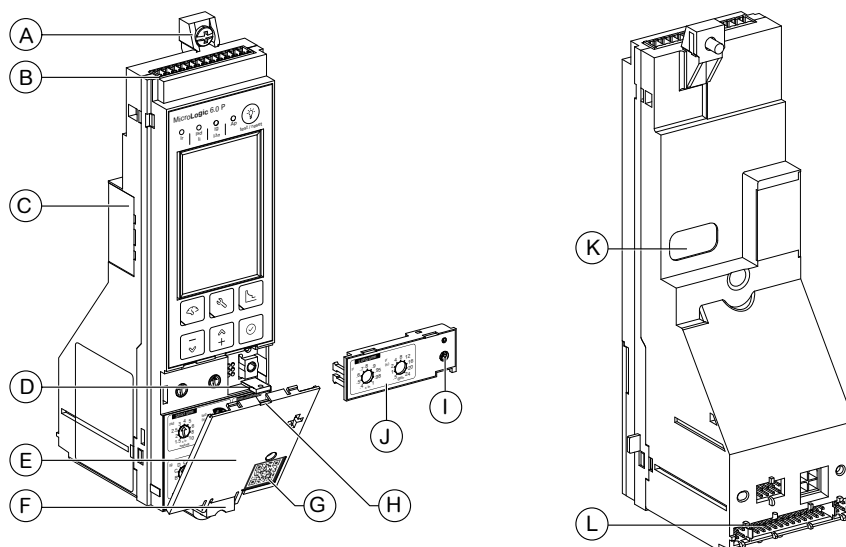

- A. Top fastener
- B. Terminal block for external connections
- C. Battery compartment
- D. Lead-seal fixture for protective cover
- E. Protective cover
- F. Bottom fastener
- G. QR code on protective cover, to access product information
- H. Cover opening point
- I. Screw for long-time rating plug
- J. Long-time rating plug
- K. Infrared link with communication interface
- L. Connection with circuit breaker

MicroLogic 5.0 P Trip Unit

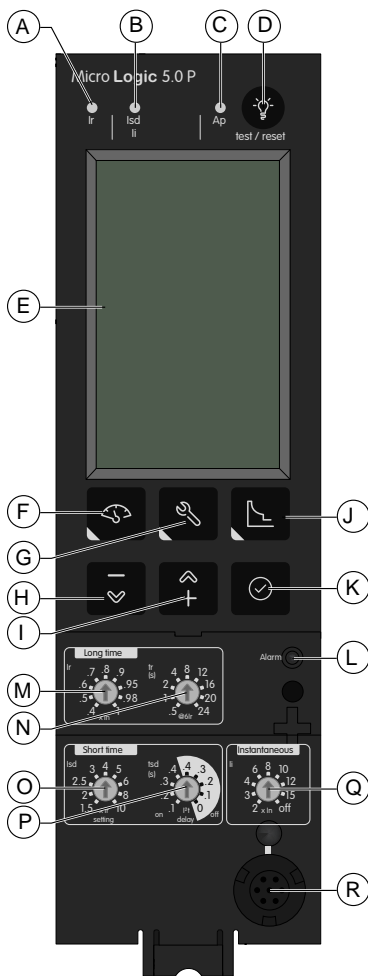

- A. Long-time trip cause indication LED
- B. Short-time or instantaneous trip cause indication LED
- C. Additional protection or auto-protection trip cause indication LED
- D. Fault-trip reset and battery test button
- E. Digital display
- F. Metering menu button with LED
- G. History, maintenance and setup menu button with LED
- H. Scroll down or reduce displayed value button
- I. Scroll up or increase displayed value button
- J. Protection menu button with LED
- K. Menu selection button
- L. LED indicating an overload
- M. Long-time current setting Ir
- N. Long-time time delay tr
- O. Short-time pickup Isd
- P. Short-time time delay tsd
- Q. Instantaneous pickup li
- R. Test connector

MicroLogic 6.0 P Trip Unit

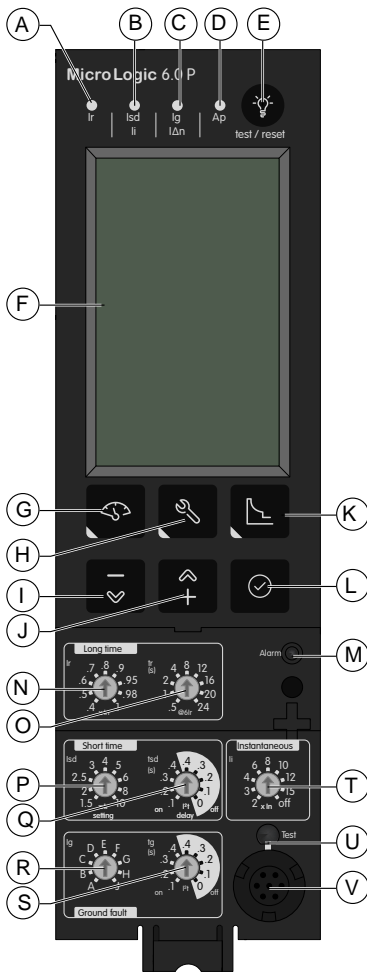

- A. Long-time trip cause indication LED
- B. Short-time or instantaneous trip cause indication LED
- C. Ground-fault trip cause indication LED
- D. Additional-protection or auto-protection trip cause indication LED
- E. Fault-trip reset and battery test button
- F. Digital display
- G. Metering menu button with LED
- H. History, maintenance and setup menu button with LED
- I. Scroll down or reduce displayed value button
- J. Scroll up or increase displayed value button
- K. Protection menu button with LED
- L. Menu selection button
- M. LED indicating an overload
- N. Long-time current setting I_r
- O. Long-time time delay t_r
- P. Short-time pickup I_{sd}
- Q. Short-time time delay t_{sd}
- R. Ground-fault pickup I_g
- S. Ground-fault time delay t_g
- T. Instantaneous pickup I_i
- U. Test button for ground-fault protection
- V. Test connector

MicroLogic 7.0 P Trip Unit

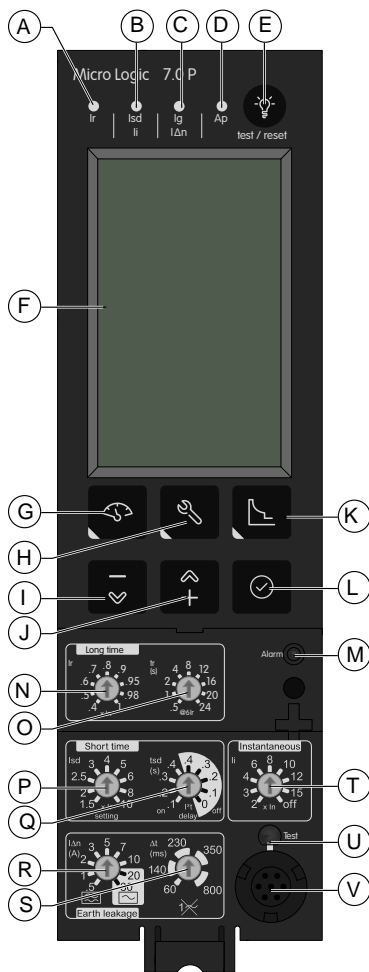

- A. Long-time trip cause indication LED
- B. Short-time or instantaneous trip cause indication LED
- C. Earth-leakage trip cause indication LED
- D. Additional-protection or auto-protection trip cause indication LED
- E. Fault-trip reset and battery test button
- F. Digital display
- G. Metering menu button with LED
- H. History, maintenance and setup menu button with LED
- I. Scroll down or reduce displayed value button
- J. Scroll up or increase displayed value button
- K. Protection menu button with LED
- L. Menu selection button
- M. LED indicating an overload
- N. Long-time current setting Ir
- O. Long-time time delay tr
- P. Short-time pickup Isd
- Q. Short-time time delay tsd
- R. Earth-leakage pickup IΔn
- S. Earth-leakage time delay Δt
- T. Instantaneous pickup Ii
- U. Test button for earth-leakage protection
- V. Test connector

LEDs and Display Screens

MicroLogic P trip units are equipped with overload and fault indication LEDs.

Overload LED

The overload LED indicates that the long-time current setting I_r has been overrun. The bar graph displays the overload as a percentage of I_r . The load level on each phase is displayed, with the most heavily loaded phase outlined.

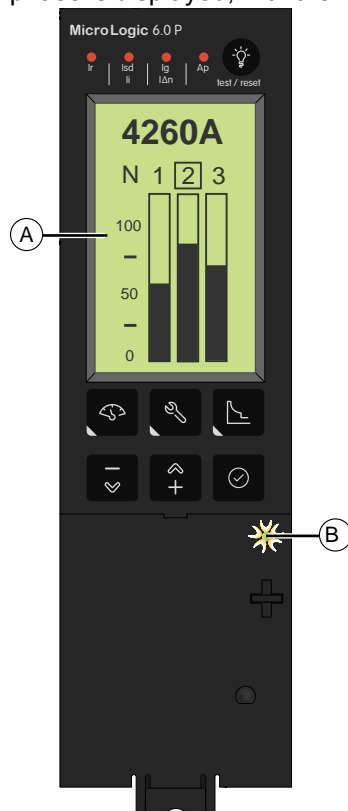

- A. Overload bar graph on the default screen
- B. LED Indicator

Trip Cause Indications

A trip is signalled by the following means:

- Trip cause indication LEDs
- Trip cause notification displayed on the screen

The trip cause notifications depend on the following factors:

- The presence of an external power supply. For more information about external power supplies, refer to [Power supply](#), page 110.
- The connection of voltage measurement inputs upstream or downstream.

Example showing trip unit without an external power supply and with voltage measurement input connected downstream

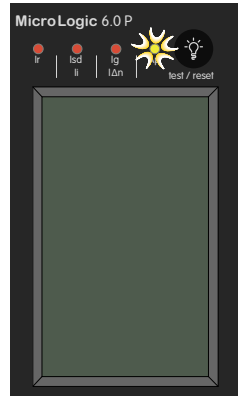

Example showing trip unit with an external power supply or with voltage measurement input connected upstream

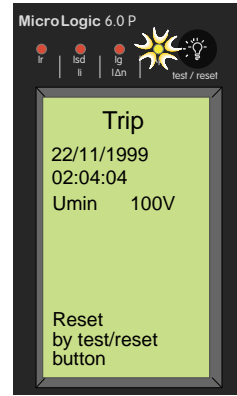

Trip Cause Indication LEDs

The indications of the four trip cause LEDs depend on the type of MicroLogic trip unit.

LED	Description
	MicroLogic 5.0 P, 6.0 P, 7.0 P: Trip due to long-time protection
	MicroLogic 5.0 P, 6.0 P, 7.0 P: Trip due to short-time protection or instantaneous protection
	<ul style="list-style-type: none"> MicroLogic 5.0 P: Not applicable MicroLogic 6.0 P: Trip due to ground-fault protection MicroLogic 7.0 P: Trip due to earth-leakage protection
	<p>MicroLogic 5.0 P, 6.0 P, 7.0 P: Trip due to auto-protection or additional protection</p> <p>Auto-protection functions:</p> <ul style="list-style-type: none"> Temperature ASIC power supply Instantaneous pickup for circuit breaker self protection <p>Additional protection functions:</p> <ul style="list-style-type: none"> Current unbalance I unbal Maximum current I1 max, I2 max, I3 max, IN max Voltage unbalance U unbal Overvoltage U max Undervoltage U min Reverse power rP max Overfrequency F max Overfrequency F min

When activated, a LED remains ON until it is locally reset.

NOTE:

- A number of simultaneous causes may result in tripping. The LED signalling the last trip cause chronologically is the only one to remain ON.
- The battery maintains the trip cause indications. If there are no indications, check the battery.

Resetting Trip Cause Indications

1. Determine why the circuit breaker tripped. The trip cause indication is maintained until it is reset on the trip unit.
2. Press  to reset the trip cause indication LED.

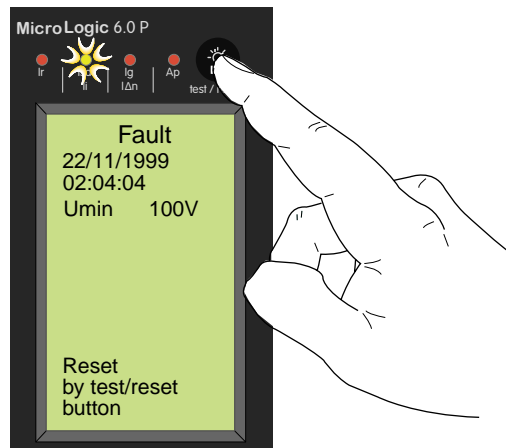

NOTE: If the circuit breaker remains closed and the Ap LED remains ON after the reset, open the circuit breaker and contact your field service representative.

For more information about the procedure for resetting and closing the circuit breaker after a trip, refer to [DOCA0221EN ComPacT NS - Circuit Breakers and Switch-Disconnectors - User Guide](#).

Go2SE Landing Page

Presentation

When the QR code on the front face of a ComPacT NS device is scanned with a smartphone running a QR code reader and connected to the Internet, the Go2SE landing page is displayed.

The landing page displays information about the device and a list of menus.

Landing Page Description

The landing page is accessible from Android and iOS smartphones. It displays the same list of menus with slight differences in presentation.

The following example shows the landing page displayed on an Android smartphone:

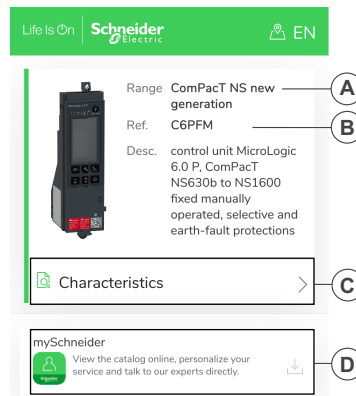

- A. Commercial reference of MicroLogic trip unit
- B. Type of MicroLogic trip unit
- C. Landing page menus. See the following menu descriptions for details.
- D. Downloadable applications

Characteristics

Selecting this menu gives access to a product datasheet with detailed information about the MicroLogic trip unit.

Documentation

Selecting this menu gives access to the ComPacT NS technical publications.

mySchneider App

Selecting this application gives access to the Schneider Electric customer care mobile application **mySchneider** app that can be downloaded on Android and iOS smartphones. For smartphone compatibility, check on your application store. The customer care application offers self-service instructions and easy access to expert support and information.

Using the MicroLogic P Human Machine Interface

What's in This Part

MicroLogic P HMI Description	19
Tree Navigation.....	20
MicroLogic P Screens.....	22
Setting Up the MicroLogic Functions.....	30

MicroLogic P HMI Description

The human machine interface (HMI) of the MicroLogic P trip unit includes:

- A graphic display screen
- Buttons to navigate through the menu structure, and access monitored parameters and configuration settings

Display Screen and Buttons

The MicroLogic P trip unit includes the following display screen and buttons:

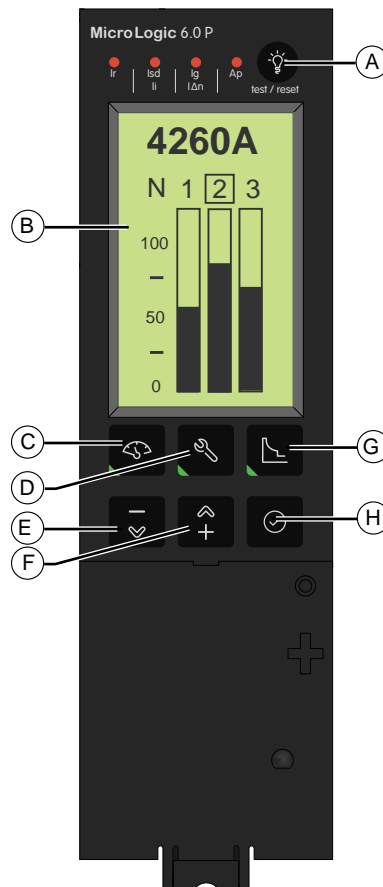

- A. Fault-trip reset and battery test button
- B. Digital display
- C. Metering menu button with LED
- D. History, maintenance and setup menu button with LED
- E. Scroll down or reduce displayed value button
- F. Scroll up or increase displayed value button
- G. Protection menu button with LED
- H. Menu selection button

Menu LEDs

The activated LED indicates the menu for which the screen is displayed:

- **Metering**
- **History, maintenance and setup**
- **Protection**

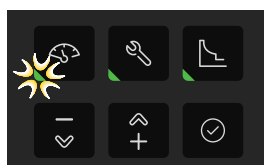



Tree Navigation

Tree Structure Screen Display

The navigation trees provide access to all the screens of MicroLogic P trip units.

The different screens are organized in branches corresponding to a given type of information.

The following branches are available, in the indicated order, depending on the type of MicroLogic trip unit:

Branch (type of information)	Button to access branch	Screens
Metering, page 23		Current I
		Voltage V
		Power P
		Energy E
		Frequency F
History and setup, page 25		Event history
		Contacts M2C/M6C
		MicroLogic setup
		Com. setup
Protection, page 27		Current protection
		Voltage protection
		Other protection
		Load shedding I
		Load shedding P

Default Screen

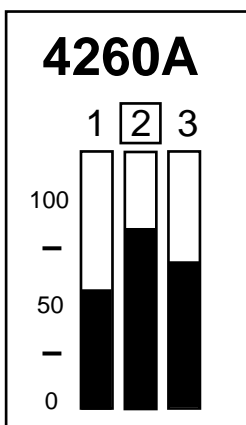

All menu selections start at the default screen.

The default screen displays:

- A bar graph representing the instantaneous values of the phase currents I1, I2, I3 and the neutral current IN (for 4–pole circuit breakers).
- The value in amperes of the most heavily loaded phase. The number for that phase is presented in a square.





The current in the neutral is displayed if the neutral CT is set as internal or external (refer to **Ineutral (A)** settings in the **Current protection** menu, page 57).

Navigating with the Keypad Buttons

Use the keypad buttons on the face of the MicroLogic P trip unit to navigate in the menu structure, and to access displayed values and configurable settings.

The possible operations are listed below:



- Display data, for example, energy values
- Reset values or counters, for example, reset the maximum power
- Select options in a list, for example, language
- Set protection functions, for example, long-time protection

Button	Description
	Press the branch menu buttons to: <ul style="list-style-type: none"> • Open the branch of a tree. The green LED on the button lights. • Return to the previous screen (if LED is lit) • Return to the default screen (if LED is not lit) NOTE: The LED goes OFF on exiting the menu. 
	Press the arrow buttons to: <ul style="list-style-type: none"> • Scroll up or down through the different screens of a branch. • Reduce or increase the displayed value. Press the - button to reset the displayed values Press the + button to cancel the reset of the displayed values
	Press this button to select or confirm a choice.

Whatever the screen displayed, if no further action is taken, the system returns to the default screen after a few minutes.

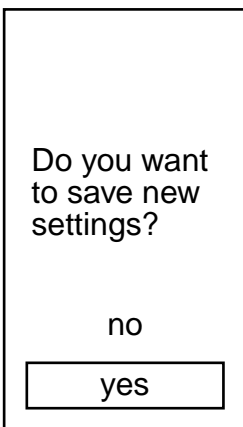
Saving Settings



When a setting is changed in any of the three menus, pressing one of the three buttons ,  or  displays the screen used to save the modification(s).

- Select **yes** to save the modifications.
- Select **no** to cancel and maintain the previous settings.
- This screen is displayed until **yes** or **no** is selected.

Reset Maximum Values

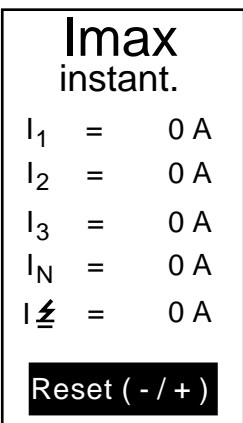

The maximum values can be reset when they are displayed on the screen:

- Press - to reset all maximum values displayed on the screen
- Press + to cancel the reset and restore the maximum values

MicroLogic P Screens

What's in This Chapter

Metering Menu	23
History, Maintenance, and Setup Menu	25
Protection Menu	27

Metering Menu

Description

I	(A)
U	(V)
P	(kW)
E	(kWh)
F	(Hz)

The **Metering** menu contains the following submenus:

Level 1	Level 2	Function description
Default screen	I (A)	Current measurements
	U (V)	Voltage measurements
	P (kW)	Power measurements
	E (kWh)	Energy measurements
	F (Hz)	Frequency measurements

Navigation

Use the buttons below the display screen to navigate the menus, page 20.

Current Measurements

I inst.
I1, I2, I3, IN
Max

Level 2	Level 3	Level 4	Description	
I (A)	I inst	I1	<ul style="list-style-type: none"> I1: Instantaneous current on phase 1 I2: Instantaneous current on phase 2 I3: Instantaneous current on phase 3 IN: Instantaneous current on neutral (depending on the type of system) 	
		I2		
		I3		
		IN		
			Max	Storing and reset of the maximum instantaneous currents
	Demand	$\bar{I}1$	<ul style="list-style-type: none"> $\bar{I}1$: demand current on phase 1 $\bar{I}2$: demand current on phase 2 $\bar{I}3$: demand current on phase 3 $\bar{I}N$: demand current on neutral (depending on the type of system) 	
		$\bar{I}2$		
		$\bar{I}3$		
$\bar{I}N$				
		Max	Storing and reset of the maximum demand currents	

Voltage Measurements

U (V)
Instant.
Average 3Φ
Unbal 3Φ
Phase rotation

Level 2	Level 3	Description
U (V)	Instant.	Instantaneous phase-to-phase U12, U23, U31 and phase-to-neutral V1N, V2N, V3N voltages (depending on the type of system)
	Average 3 Φ	Average voltage U average of the phase-to-phase voltages.
	Unbal 3 Φ	Unbalance voltage U unbal. of the phase-to-phase voltages.
	Phase rotation	Phase sequence

Power Measurements

P_{inst.}
P, Q, S
Power factor

Level 2	Level 3	Level 4	Description
P (kW)	P inst.	P, Q, S	<ul style="list-style-type: none"> • Total active power P • Total reactive power Q • Total apparent power S
		Power factor	Power factor PF
	Demand	$\bar{P}, \bar{Q}, \bar{S}$	Demand values for: <ul style="list-style-type: none"> • Total active power P • Total reactive power Q • Total apparent power S
		Max	Storing and reset of the maximum demand power values

Energy Measurements

E (kWh)
E total
E in
E out
Reset Energy

Level 2	Level 3	Description
E (kWh)	E total	<ul style="list-style-type: none"> • Total active energy E.P • Total reactive energy E.Q • Total apparent energy E.S
	E in	Positive component of: <ul style="list-style-type: none"> • The total active energy E.P • The total reactive energy E.Q
	E out	Negative component of: <ul style="list-style-type: none"> • The total active energy E.P • The total reactive energy E.Q
	Reset Energy	Reset all the energy values to zero.

Frequency Measurements

F (Hz)
60.0

Level 2	Description
F (Hz)	Frequency F

History, Maintenance, and Setup Menu

Description

The **History, Maintenance, and Setup** menu contains the following submenus:

Level 1	Level 2	Function description
Default screen	Event history	Displays information about trips, alarms, operations and contact wear.
	M2C / M6C contacts	Not applicable
	MicroLogic setup	Gives access to setup of the MicroLogic trip unit.
	Metering setup	Gives access to the setup of the metering parameters.
	Com. setup	Gives access to setup of communication option.

Navigation

Use the buttons below the display screen to navigate the menus, page 20.

Event History

Event history
Contacts M2C / M6C
Micrologic setup
Metering setup
Com. setup

Level 2	Level 3	Description
Event history	Trip history	The last ten trips recorded
	Alarm history	The last ten alarms recorded
	Operation counter	Number of operations (opening or closing)
	Contact wear	Wear of the circuit breaker main contacts

MicroLogic Setup

Event history
Contacts M2C / M6C
Micrologic setup
Metering setup
Com. setup

Level 2	Level 3	Description
MicroLogic setup	Language	Selection of the display language
	Date / time	Setting of the date and time
	Breaker selection	Indication of the circuit breaker type
	Power sign	Setting the power sign
	VT ratio	Selection of the primary and secondary voltages of the voltage transformation ratio
	System frequency	Indication of the rated system frequency

Metering Setup

Event history
Contacts M2C / M6C
Micrologic setup
Metering setup
Com. setup

Level 2	Level 3	Description
Metering setup	System type	<ul style="list-style-type: none"> • 3 phases, 3 wires, 3 CTs: method using two wattmeters • 3 phases, 4 wires, 3 CTs: method using three wattmeters • 3 phases, 4 wires, 4 CTs: method using three wattmeters with measurement of the neutral current
	Current demand	Selection of the calculation method and setting of the parameters for the calculation
	Power demand	Selection of the calculation method and setting of the parameters for the calculation
	Sign convention	Setting of the sign convention for the power factor and reactive power, i.e. IEEE, IEEE alternate or IEC (see Power Factor Sign Conventions , page 121 to determine the sign convention)

Communication Option Setup

Event history
Contacts M2C / M6C
Micrologic setup
Metering setup
Com. setup

Level 2	Level 3	Description
Com. setup	Com. parameter	Setting of parameters for the COM communications option
	Remote settings	Authorisation of access to settings via the COM communications option
	Remote control	Authorisation of access to the circuit breaker ON and OFF commands via the COM communications option
	IP Data	Displays the IP address of the IFE

Protection Menu

Description

The **Protection** menu contains the following submenus:



Level 1	Level 2	Function description
Default screen	Current protection	Current protection functions.
	Voltage protection	Minimum, maximum and unbalance protection functions.
	Other protection	Reverse power, frequency , and phase rotation functions.
	Load shedding I	Load shedding depending on current.
	Load shedding P	Load shedding depending on power.

Navigation

Use the buttons below the display screen to navigate the menus, page 20.

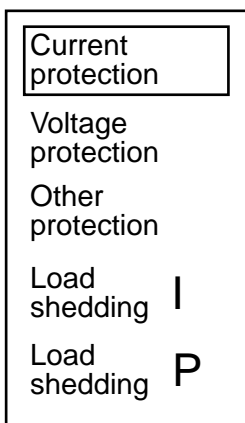
Current Protection



Level 2	Level 3	Description
Current protection	I (A)	Fine settings of the I ² t long-time, short-time and instantaneous protection functions
	Idmtl (A)	Fine settings of the Idmtl long-time, short-time and instantaneous protection functions
	I  (A)	Fine settings of the: <ul style="list-style-type: none"> • Ground-fault protection on MicroLogic 6.0 P trip unit • Earth-leakage protection on MicroLogic 7.0 P trip unit
	Ineutral (A)	Selection of the type of neutral sensor and type of neutral protection
	I  alarm	Setting of the I  alarm
	Iunbal (%)	Setting of the current-unbalance protection I unbal
	I1 max (A)	Setting of the maximum-current protection I1 max
	I2 max (A)	Setting of the maximum-current protection I2 max
	I3 max (A)	Setting of the maximum-current protection I3 max
	IN max (A)	Setting of the maximum-current protection IN max

Voltage Protection

Current protection

Voltage protection

Other protection

Load shedding I

Load shedding P

Level 2	Level 3	Description
Voltage protection	U min (V)	Setting of the minimum-voltage protection U min
	U max (V)	Setting of the maximum-voltage protection U max
	U unbal (%)	Setting of the voltage-unbalance protection U unbal

Other Protection

Current protection

Voltage protection

Other protection

Load shedding I

Load shedding P

Level 2	Level 3	Description
Other protection	rP max (W)	Setting of the reverse-power protection rP max
	F min (Hz)	Setting of the minimum-frequency protection F min
	F max (Hz)	Setting of the maximum-frequency protection F max
	Phase rotation	Setting of the phase-rotation protection

Load Shedding Depending on Current

Current protection

Voltage protection

Other protection

Load shedding I

Load shedding P

Level 2	Description
Load shedding I	Load shedding depending on current

Load Shedding Depending on Power

Current protection
Voltage protection
Other protection
Load shedding I
Load shedding P

Level 2	Description
Load shedding P	Load shedding depending on power

Setting Up the MicroLogic Functions

What's in This Chapter









Setting Up the MicroLogic Trip Unit	31
Setting Up the Metering Functions	38
Setting Up the COM Communications Option	42

Setting Up the MicroLogic Trip Unit

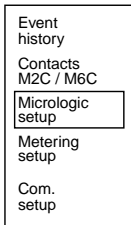
Prior to setting up the protection functions or carrying out measurements, set up the following parameters of the MicroLogic trip unit:

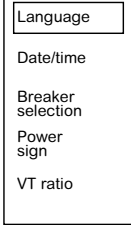
- Display language
- Date and time
- Circuit breaker type
- Power sign
- Transformation ratio between the primary and secondary windings (if an auxiliary voltage transformer is installed)
- Rated frequency





Selecting the Display Language

Step	Action	
1	Press  . The History, Maintenance and Setup menu opens. Press  to select MicroLogic setup	
2	Press  . The MicroLogic setup menu opens. The Language menu is selected by default.	
3	Press  . The Language menu opens. Press  to select the required language.	
4	Press  to confirm the selection. The hour glass displays while the settings is being saved.	

Returning to English

1. Return to the default screen by pressing any of the three buttons without a lit LED:















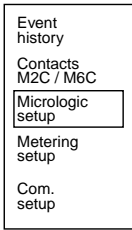

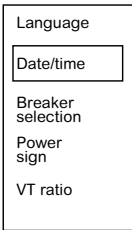

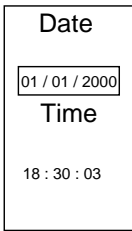

or press  followed by any of the three buttons   .

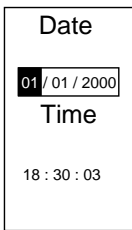

2. Select the **History, maintenance and setup** menu by pressing .
3. Move the cursor to the first menu item and then down to the third menu item to select the **MicroLogic setup** menu .

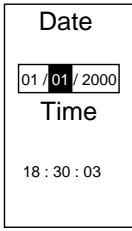
4. Select **Language** by moving the cursor up to the first menu item. Press  to confirm the selection.
5. Select English from the list and confirm the selection.

Setting the Date and Time

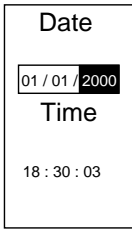
Follow this procedure to set the date and time of the MicroLogic trip unit. The date and time are used for time-stamping in the trip and alarm histories.

Step	Action	
1	Press  . The History, Maintenance and Setup menu opens. Press  to select MicroLogic setup	
2	Press  . The MicroLogic setup menu opens. Press  to select Date and time .	
3	Press  . The Date and time menu opens.	
4	Press  . The day element of the date is highlighted. Use the  and  buttons to select the day.	
5	Press  . The month element of the date is highlighted. Use  and  to select the month.	
6	Press  . The year element of the date is highlighted. Use  and  to select the year.	

Step	Action
7	Press  .
8	Press  to select the time. Press  . The hour element of the time is highlighted. Set the time (hours, minutes and seconds) in the same way as for the date. The resolution of the time setting is 20 ms.

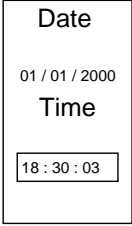







NOTE: Date and time are backed up by battery.

NOTE: If the MicroLogic trip unit is connected to an Ethernet interface configured in SNTP mode, manual update of the MicroLogic date and time is possible but is immediately replaced by the date and time of the Ethernet interface.





If time is not synchronized via the communication module, a drift of up to one hour per year may be observed.

Selecting the Circuit Breaker

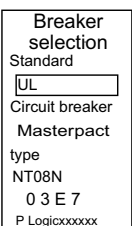
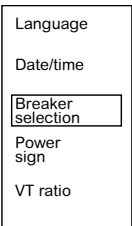
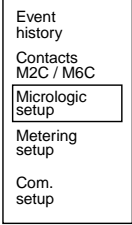
Follow this procedure to set the characteristics of the circuit breaker.

Step	Action
1	Press  . The History, Maintenance and Setup menu opens. Press  to select MicroLogic setup
2	Press  . The MicroLogic setup menu opens. Press  to select Breaker selection .
3	Press  . The Breaker selection menu opens. Press  to select Standard .











Step	Action	
4	<p>Press . The Standard options are highlighted. The default setting is Not def.</p> <p>Press  to select the required standard.</p> <ul style="list-style-type: none"> • IEC/GB • ANSI • IEC • UL 	<div style="border: 1px solid black; padding: 5px;"> <p>Breaker selection</p> <p>Standard</p> <p>IEC</p> <p>Circuit breaker</p> <p>Masterpact</p> <p>type</p> <p>NT H1</p> <p>0 3 E 7</p> <p>P Logicxxxxx</p> </div>
5	<p>Use the navigation buttons to access and set the Circuit breaker.</p> <p>Press  to confirm the selection.</p>	<div style="border: 1px solid black; padding: 5px;"> <p>Breaker selection</p> <p>Standard</p> <p>IEC</p> <p>Circuit breaker</p> <p>ComPact NS</p> <p>type</p> <p>630b</p> <p>0 3 E 7</p> <p>P Logicxxxxx</p> </div>
6	<p>Use the navigation buttons to access and set the type.</p>	<div style="border: 1px solid black; padding: 5px;"> <p>Breaker selection</p> <p>Standard</p> <p>IEC</p> <p>Circuit breaker</p> <p>Compact NS</p> <p>type</p> <p>800</p> <p>0 3 E 7</p> <p>P Logicxxxxx</p> </div>
7	<p>Press  to confirm the selection.</p>	
8	<p>Note the circuit breaker code (code = 03E7 in the example).</p> <p>The circuit breaker code is required to identify the device and activate the contact-wear counter.</p> <p>Enter this code when setting up a new trip unit on the circuit breaker.</p> <p>For a new device, the code is set to zero.</p> <p>When the main circuit-breaker contacts are replaced, this code must be reset to zero.</p>	

NOTE: If the phase-rotation protection function is activated, do not select the 400 Hz frequency. If the 400 Hz frequency is selected, the phase-rotation protection function is disabled.

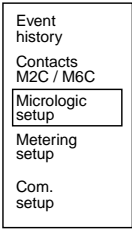
Selecting the Sign of the Power

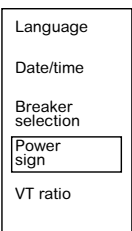
By default, the MicroLogic P trip unit uses P+ for the power flowing from top to bottom terminals. The selected direction of flow is valid for:

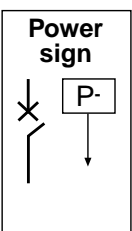

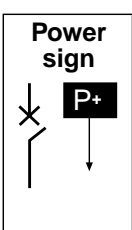





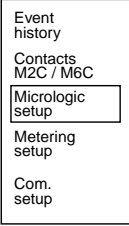

- Measurement of power and the power factor
- Measurement of energy
- Load shedding and reconnection depending on power

Step	Action	
1	Press  . The History, Maintenance and Setup menu opens. Press  to select MicroLogic setup	
2	Press  . The MicroLogic setup menu opens. Press  to select Power sign .	
3	Press  . The Power sign menu opens.	
4	Use the navigation buttons to access and set the Power sign . Press  to confirm the selection.	

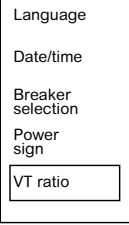

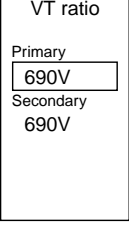

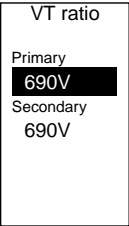

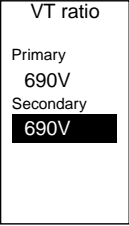

Entering the Voltage-Transformation Ratio

If the supply voltage for the trip unit exceeds 690 V, install a PTE external voltage measurement input option, page 103 and an external voltage transformer.

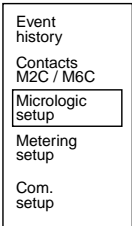
If an external voltage transformer is installed, to display the true voltage values, enter the transformation ratio between the primary and secondary voltages of the transformer.

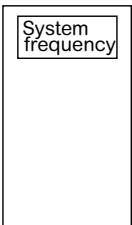
Step	Action	
1	Press  . The History, Maintenance and Setup menu opens. Press  to select MicroLogic setup	
2	Press  . The MicroLogic setup menu opens. Press  to select VT ratio .	
3	Press  . The VT ratio menu opens.	
4	Use the navigation buttons to access and set the Primary VT ratio. Press  to confirm each selection.	
5	Use the navigation buttons to access and set the Secondary VT ratio. Press  to confirm each selection.	

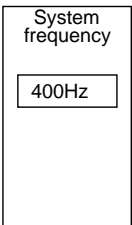
Entering the Rated Frequency

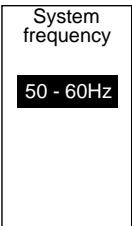
Step	Action	
1	Press  . The History, Maintenance and Setup menu opens. Press  to select MicroLogic setup	
2	Press  . The MicroLogic setup menu opens. Press  to select System frequency .	
3	Press  . The System frequency menu opens.	
4	Use the navigation buttons to access and set the frequency. Press  to confirm the selection.	

NOTE: If the phase-rotation protection function is activated, do not select the 400 Hz frequency. If the 400 Hz frequency is selected, the phase-rotation protection function is disabled.

Setting Up the Metering Functions

Prior to setting up the protection functions or carrying out measurements, set up the following parameters of the MicroLogic trip unit:

- System type
- Calculation mode for the demand current
- Calculation mode for the demand power
- Power factor sign convention

Selecting the System Type

The MicroLogic P trip unit offers three measurement options, as indicated in the table. The availability of measurements depends on the option selected.

Measurement type	Currents on phases I1, I2, I3	Current on neutral IN	Phase-to-phase voltages U12, U23, U31	Phase-to-neutral voltages V1N, V2N, V3N
3 phases, 3 wires, 3 CTs (method using two wattmeters)	✓	–	✓	–
3 phases, 4 wires, 3 CTs (method using three wattmeters)	✓	–	✓	✓
3 phases, 4 wires, 4 CTs (method using three wattmeters)	✓	✓	✓	✓

NOTE: It is advised not to use the **3-phase, 4-wire, 4-CT** type of measurement unless the neutral is effectively connected to the trip unit (four-pole circuit breaker with an external voltage-measurement input).

Step	Action	
1	Press . The History, Maintenance and Setup menu opens. Press to select Metering setup	<div style="border: 1px solid black; padding: 5px;"> Event history Contacts M2C / M6C Micrologic setup <div style="border: 1px solid black; padding: 2px; display: inline-block;">Metering setup</div> Com. setup </div>
2	Press . The Metering setup menu opens. Press to select System type .	<div style="border: 1px solid black; padding: 5px;"> System type <div style="border: 1px solid black; padding: 2px; display: inline-block;">3Φ 4w 3CT</div> </div>
3	Use the navigation buttons to access and set the System type . Press to confirm the selection.	<div style="border: 1px solid black; padding: 5px;"> System type <div style="border: 1px solid black; padding: 2px; display: inline-block; background-color: black; color: white;">3Φ 3w 3CT</div> </div>

NOTE: The neutral current IN cannot be measured with the **3-phase, 3-wire, 3-CT** and **3-phase, 4-wire, 3-CT** types.

For a 3-pole device, the neutral, if distributed, must be connected to terminal VN of the MicroLogic P trip unit.

For more information about types of measurements, refer to Measurements, page 82.

Selecting the Calculation Method for Demand Current







Step	Action	
1	<p>Press . The History, Maintenance and Setup menu opens.</p> <p>Press to select Metering setup</p>	<div style="border: 1px solid black; padding: 5px;"> Event history Contacts M2C / M6C Micrologic setup <div style="border: 1px solid black; padding: 2px; display: inline-block;">Metering setup</div> Com. setup </div>
2	<p>Press . The Metering setup menu opens.</p> <p>Press to select Current demand.</p>	
3	<p>Press . The Current demand menu opens.</p>	<div style="border: 1px solid black; padding: 5px;"> Current demand Calculation method <div style="border: 1px solid black; padding: 2px; display: inline-block;">thermal</div> Window type sliding Interval 15 min </div>
4	<p>Use the navigation buttons to access and set the Calculation method.</p> <ul style="list-style-type: none"> • Thermal • Block interval <p>NOTE: The thermal method is based on I²t calculation.</p> <p>Press to confirm the selection.</p>	<div style="border: 1px solid black; padding: 5px;"> Current demand Calculation method <div style="background-color: black; color: white; padding: 2px; display: inline-block;">block interval</div> Window type sliding Interval 15 min </div>
5	<p>Use the navigation buttons to access and set the Window type.</p> <ul style="list-style-type: none"> • sliding • fixed <p>Press to confirm the selection.</p>	<div style="border: 1px solid black; padding: 5px;"> Current demand Calculation method thermal Window type <div style="border: 1px solid black; padding: 2px; display: inline-block;">sliding</div> Interval 15 min </div>
6	<p>Use the navigation buttons to access and set the Interval (5 to 60 minutes in 1 min steps).</p> <p>Press to confirm the selection.</p>	<div style="border: 1px solid black; padding: 5px;"> Current demand Calculation method block interval Window type sliding Interval <div style="background-color: black; color: white; padding: 2px; display: inline-block;">20 min</div> </div>

Selecting the Calculation Method for Demand Power

Step	Action	
1	<p>Press . The History, Maintenance and Setup menu opens.</p> <p>Press to select Metering setup</p>	<div style="border: 1px solid black; padding: 5px;"> Event history Contacts M2C / M6C Micrologic setup Metering setup Com. setup </div>
2	<p>Press . The Metering setup menu opens.</p> <p>Press to select Power demand.</p>	
3	<p>Press . The Power demand menu opens.</p>	<div style="border: 1px solid black; padding: 5px;"> Power demand Calculation method thermal Window type sliding Interval 15 min </div>
3	<p>Use the navigation buttons to access and set the Calculation method.</p> <ul style="list-style-type: none"> • Thermal • Block interval <p>NOTE: The thermal method is based on I²t calculation.</p> <p>Press to confirm the selection.</p>	<div style="border: 1px solid black; padding: 5px;"> Power demand Calculation method block interval Window type sliding Interval 15 min </div>
4	<p>Use the navigation buttons to access and set the Window type.</p> <ul style="list-style-type: none"> • sliding • fixed <p>Sliding window: Power demand is refreshed every 15 seconds.</p> <p>Fixed window: Power demand is refreshed at the end of the time interval.</p> <p>Press to confirm the selection.</p>	<div style="border: 1px solid black; padding: 5px;"> Power demand Calculation method block interval Window type sliding Interval 15 min </div>
5	<p>Use the navigation buttons to access and set the Interval (5 to 60 minutes in 1 min steps).</p> <p>Press to confirm the selection.</p>	<div style="border: 1px solid black; padding: 5px;"> Power demand Calculation method block interval Window type fixed Interval 20 min </div>

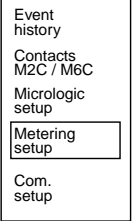
NOTE: The synchronization function **Synchro.Com** is available only with the COM communication option. With this function, the demand power is determined on the basis of a signal synchronized by the communication module.

Setting Up the Power-Factor Calculation

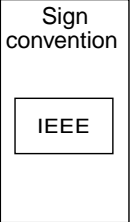
Step	Action	
1	Press  . The History, Maintenance and Setup menu opens. Press  to select Metering setup	
2	Press  . The Metering setup menu opens. Press  to select Sign convention .	
3	Use the navigation buttons to access and set the Sign convention . <ul style="list-style-type: none"> • IEEE • IEEE alt • IEC Press  to confirm the selection.	

For more information, refer to *Power Factor Sign Conventions* , page 121.

Setting Up the COM Communications Option

NOTICE

HAZARD OF LOSS OF COMMUNICATION

Do not change the communication parameters on a system in operation.

Failure to follow these instructions can result in data loss.

The communication parameters have default values that can or must be changed according to the needs of the installation or users.

When a COM communications option is used, it is necessary to:

- Set up the COM communications option.
- Authorize remote setting of the MicroLogic trip unit.
- Authorize remote control of the circuit breaker.







Setting Up the Modbus Address

The Modbus address is a two-digit number identifying the MicroLogic P trip unit in a Modbus network.

NOTE: As soon as the communications option is connected, the trip unit recognizes it and displays the type of module on the graphic screen. Automatic time updates are possible only with the Modbus system.

The setting of the Modbus address depends on the COM option.

COM option	Modbus address	Modbus address range
BCM or BCM ULP not connected to IFM or IFE	The Modbus address is set up on the Modbus Com setting screen, with the parameters of the communication option (see below).	1 to 47
BCM ULP connected to IFM	The Modbus address is set up on the 2 address rotary switches on the front panel of the IFM.	1 to 99 Value 0 is forbidden because it is reserved for broadcasting messages.
BCM ULP connected to IFM with legacy firmware	The Modbus address is set up on the 2 address rotary switches on the front panel of the IFM.	1 to 47 Value 0 is forbidden because it is reserved for broadcasting messages. Values 48 to 99 are not allowed.
BCM ULP connected to IFE	The Modbus address is fixed and cannot be changed.	255

Step	Action	
1	Press  . The History, Maintenance and Setup menu opens. Press  to select Com. setup	<div style="border: 1px solid black; padding: 5px;"> Event history Contacts M2C / M6C Micrologic setup Metering setup <div style="border: 1px solid black; padding: 2px; display: inline-block;">Com. setup</div> </div>
2	Press  . The Com. setup menu opens. Press  to select Com. parameter .	<div style="border: 1px solid black; padding: 5px;"> Com. setup <div style="border: 1px solid black; padding: 2px; display: inline-block;">Com. parameter</div> Remote settings Remote control IP data </div>
4	Press  . The Modbus Com menu opens.	<div style="border: 1px solid black; padding: 5px;"> Modbus Com Address <div style="border: 1px solid black; padding: 2px; display: inline-block;">47</div> Baud-rate 9600 Parity None Connection 2Wires+ULP </div>
5	Use the navigation buttons to access and set the Address . Press  to confirm the selection.	<div style="border: 1px solid black; padding: 5px;"> Modbus Com Address <div style="background-color: black; color: white; padding: 2px; display: inline-block;">45</div> Baud-rate 9600 Parity None Connection 2Wires+ULP </div>
6	Set the Baud-rate, Parity and Connection in the same way.	<div style="border: 1px solid black; padding: 5px;"> Modbus Com Address 47 Baud-rate 9600 Parity None Connection <div style="border: 1px solid black; padding: 2px; display: inline-block;">4Wires</div> </div>

Authorizing Remote Setup of MicroLogic

Step	Action	
1	<p>Press . The History, Maintenance and Setup menu opens.</p> <p>Press to select Com. setup</p>	<div style="border: 1px solid black; padding: 5px;"> Event history Contacts M2C / M6C Micrologic setup Metering setup <div style="border: 1px solid black; padding: 2px; display: inline-block;">Com. setup</div> </div>
2	<p>Press . The Com. setup menu opens.</p> <p>Press to select Remote settings.</p>	<div style="border: 1px solid black; padding: 5px;"> Com. setup Com. parameter <div style="border: 1px solid black; padding: 2px; display: inline-block;">Remote settings</div> Remote control IP data </div>
3	<p>Use the navigation buttons and to set Access permit to Yes. Press to confirm the selection and move to the Access code.</p>	<div style="border: 1px solid black; padding: 5px;"> Remote settings Access permit <div style="background-color: black; color: white; padding: 2px; display: inline-block;">Yes</div> Access code 0 0 0 0 </div>
4	<p>Enter the access code by using the navigation buttons and to select the first digit.</p>	<div style="border: 1px solid black; padding: 5px;"> Remote settings Access permit Yes Access code <div style="border: 1px solid black; padding: 2px; display: inline-block;">1 0 0 0</div> </div>
5	<p>Press to confirm the selection and move to the following digit.</p> <p>Repeat steps 4 and 5 for the remaining digits.</p>	<div style="border: 1px solid black; padding: 5px;"> Remote settings Access permit Yes Access code <div style="border: 1px solid black; padding: 2px; display: inline-block;">1 0 0 0</div> </div>







NOTE: The access code is a password that must be provided by the supervisor prior to accessing the MicroLogic settings.

To authorize the remote setup of the MicroLogic trip unit equipped with a BCM or BCM ULP, access permit must be set to YES on the Remote settings screen.

NOTE: If the BCM or BCM ULP is connected to an IFM or IFE communication interface, the IFM or IFE locking pad must be set to UNLOCK (padlock open).

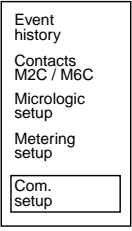
If the operator does not enter a specific access code, the default access code is 0000 and is requested by the supervisor.

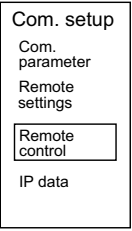
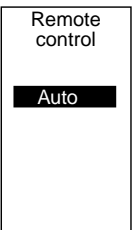
Authorizing Remote Control of the Circuit Breaker

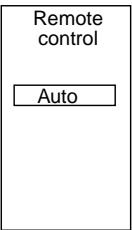
Step	Action	
1	Press  . The History, Maintenance and Setup menu opens. Press  to select Com. setup	
2	Press  . The Com. setup menu opens. Press  to select Remote control .	
3	Use the navigation buttons to access and set Remote control . <ul style="list-style-type: none"> • Manual • Auto 	
4	Press  to confirm the selection .	

NOTE: It is possible to set circuit breaker control to local only (**Manual**) or to local and remote (**Auto**).

To authorize the remote control of the circuit breaker, Auto must be set on the Remote control screen.

If the circuit breaker is connected to other ULP modules, each ULP module must be set to authorize the remote control of the circuit breaker:

- On FDM121 display unit, set the circuit breaker in remote control mode on the FDM121 Control menu
- On IO module with predefined application 2 (breaker application), set the selector switches connected to the IO module inputs to:
 - Remote control mode (I1 = 1)
 - Enable close order (I4 = 1)
- On IFM or IFE communication interface, the IFM or IFE locking pad must be set on UNLOCK (padlock open).

For more information on the communication option, refer to the:

- ULP system user guide.
- IO module user guide.
- IFE user guide.
- FDM121 user guide.

Protection Settings for MicroLogic P Trip Unit

What's in This Part

Setting Principles	47
Setting the Current Protection Functions	50
Setting the Neutral Protection	56
Setting Additional Protection Functions	58
Setting Load Shedding And Reconnection Function	61

Setting Principles

With the protective cover open, make all the necessary settings for your trip unit:

- Use the dials to set MicroLogic P protection thresholds and time delays for overloads, short-circuits, ground faults and earth leakage.

If the set thresholds are overrun, these protection functions systematically trip the circuit breaker.

- Use the buttons on the keypad:
 - For fine adjustments of the protection thresholds and time delays for overloads, short-circuits, ground faults and earth leakage. The value previously set using a dial automatically becomes the maximum value for the keypad settings
 - To activate and set the MicroLogic P functions not accessible via the dials.

With the protective cover closed, it is not possible to set the protection functions. However, it is possible to set metering functions and alarms, as well as view all measurements, settings and histories.

For remote settings using the communication option, see the **Remote settings** section in the **Com setup** menu under **History, maintenance and setup**.

Setting Protection Functions Using the Dials

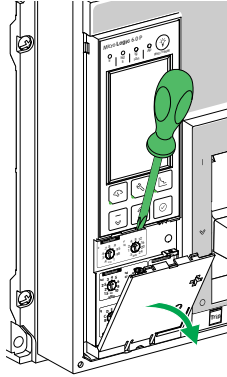
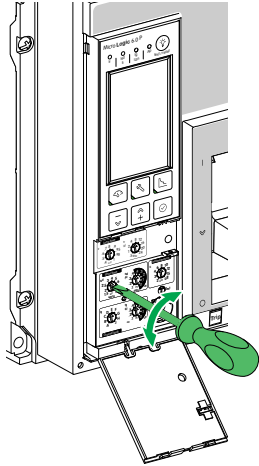
Step	Action	
1	Open the protective cover.	
2	Make the necessary settings using the dials.	
3	The screen automatically displays the relevant curve.	
4	Check the set value on the screen, in absolute value in amperes (A) and in seconds (s).	

NOTE: A new overload (long-time) or short-circuit (short-time and instantaneous) protection setting made using one of the dials:



- Deletes all the fine adjustments previously made using the keypad for the overload (long-time) and short-circuit (short-time and instantaneous) protection.
- Does not affect the fine adjustments made using the keypad for ground-fault and earth-leakage protection.
- Does not affect any other settings made using the keypad.

Similarly, a new ground-fault or earth-leakage protection setting made using one of the dials:

- Deletes all the fine adjustments previously made using the keypad for the ground-fault and earth-leakage protection.
- Does not affect the fine adjustments made using the keypad for the overload (long-time) and short-circuit (short-time and instantaneous) protection.
- Does not affect any other settings made using the keypad.

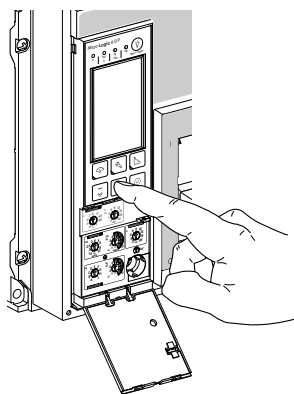
Setting Protection Functions Using the Keypad



- Use  and  under the screen to make fine adjustments of the settings made using the dials.

The fine adjustments are permanently stored in memory, unless the setting is modified using the dials.

- All the settings not available through the dials are made in the same manner, using the keypad.

Locking Access to Protection Settings

The protection settings are locked when the protective cover is closed to prevent access to the adjustment dials and to disable fine adjustments using the keypad.

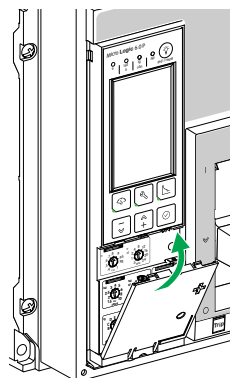

If necessary, install a lead seal to protect the settings.

NOTE: If you notice that the pin on the back of the protective cover has been broken off, contact your field service representative to replace the cover.

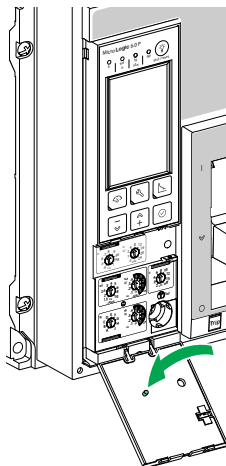

With the protective cover closed, it is possible to set metering functions and alarms, as well as view all measurements, settings and histories using the keypad.

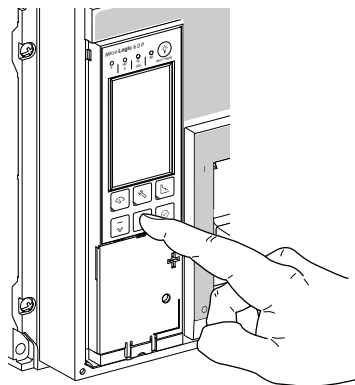

Setting the Current Protection Functions

What's in This Chapter

Setting MicroLogic 5.0 P Trip Unit	50
Setting MicroLogic 6.0 P Trip Unit	52
Setting MicroLogic 7.0 P Trip Unit	54

Setting MicroLogic 5.0 P Trip Unit

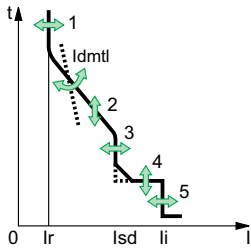

You can set the tripping curve of your MicroLogic 5.0 P trip unit to match the needs of your installation using the following parameters:

1. Long-time current setting I_r
2. Long-time time delay t_r
3. Short-time pickup I_{sd}
4. Short-time time delay t_{sd}
5. Instantaneous pickup I_i

Set the Threshold Values Using the Dials

In this example, the rated current I_n of the circuit breaker is 2000 A.

- $I_n = 2000 \text{ A}$
- $I_r = 0.5 \times I_n = 1000 \text{ A}$
- $I_{sd} = 2 \times I_r = 2000 \text{ A}$
- $I_i = 2 \times I_n = 4000 \text{ A}$

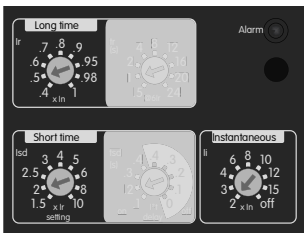

Tripping curve with I^2t short-time ON

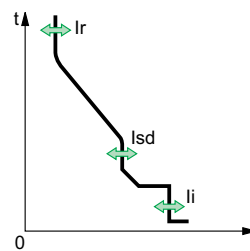

Tripping curve with I^2t short-time OFF

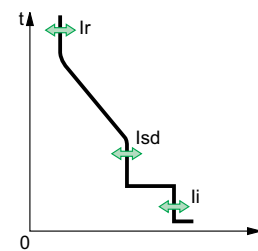

Set the Time Delays Using the Dials

In this example, time delay t_r of the circuit breaker is 1 second and time delay t_{sd} is 0.2 seconds with I^2t short-time ON.

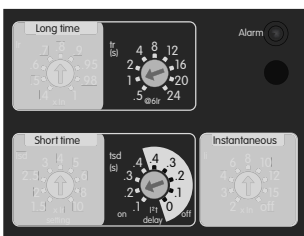

Tripping curve with I^2t short-time ON

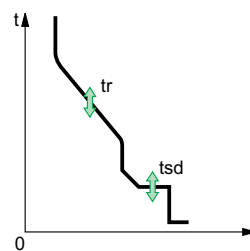

Tripping curve with I^2t short-time OFF

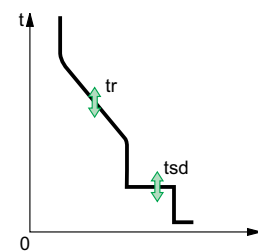

Adjusting Current Protection Settings Using the Keypad

The fine adjustment of the long-time, short-time and instantaneous current protection are possible on two different screens:

- On screen I(A) to set the I²t long-time protection with I²t tripping curve.
- On screen Idmtl (A) to set the Idmtl long-time protection with selection of one of the Idmtl tripping curves.

Adjusting I²t Long-Time, Short-Time and Instantaneous Settings Using the Keypad

1. Select  > **Current protection > I (A)**.

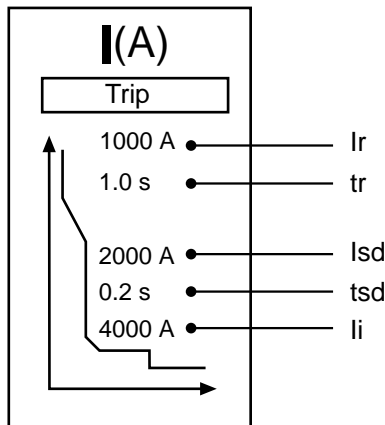

2. Use the buttons below the display screen to select, confirm, and save the settings, page 20.

Adjusting Idmtl Long-Time, Short-Time and Instantaneous Settings Using the Keypad

1. Select  > **Current protection > Idmtl (A)**.

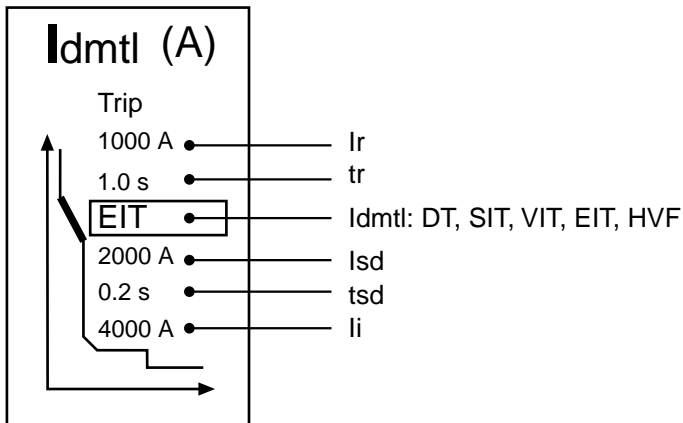

2. Use the buttons below the display screen to select, confirm, and save the settings, page 20.

Setting MicroLogic 6.0 P Trip Unit

You can set the tripping curve of your MicroLogic 6.0 P trip unit to match the needs of your installation using the following parameters:

1. Long-time current setting I_r
2. Long-time time delay t_r
3. Short-time pickup I_{sd}
4. Short-time time delay t_{sd}
5. Instantaneous pickup I_i
6. Ground-fault pickup I_g
7. Ground-fault time delay t_g

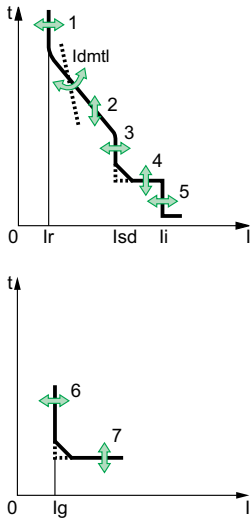

Set the Threshold Values Using the Dials

In this example, the rated current I_n of the circuit breaker is 2000 A.

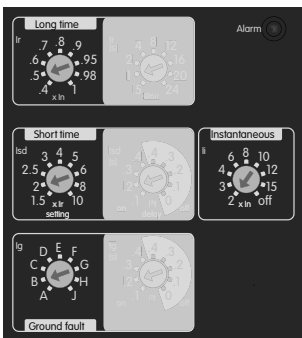

- $I_n = 2000 \text{ A}$
- $I_r = 0.5 \times I_n = 1000 \text{ A}$
- $I_{sd} = 2 \times I_r = 2000 \text{ A}$
- $I_i = 2 \times I_n = 4000 \text{ A}$
- $I_g = 640 \text{ A}$

Tripping curve with I^2t short-time ON

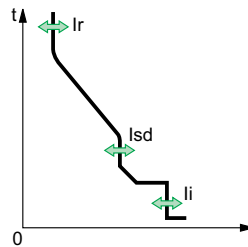

Tripping curve with I^2t short-time OFF

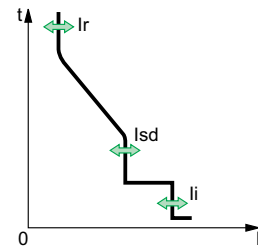

Tripping curve with I^2t ground-fault ON

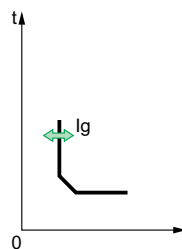

Tripping curve with I^2t ground-fault OFF

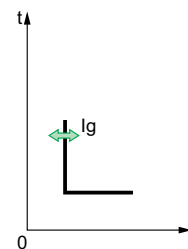

Set the Time Delays Using the Dials

In this example, time delay t_r of the circuit breaker is 1 second, time delay t_{sd} is 0.2 seconds with I^2t short-time ON, and time delay t_g is 0.2 seconds with I^2t ground-fault ON.

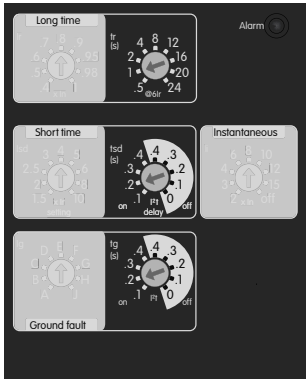

Tripping curve with I²t short-time ON

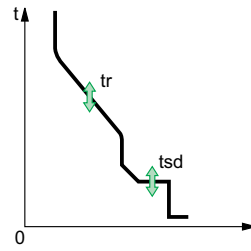

Tripping curve with I²t short-time OFF

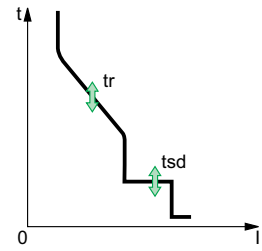

Tripping curve with I²t ground-fault ON

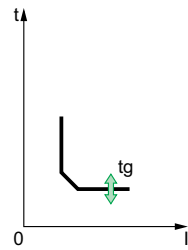

Tripping curve with I²t ground-fault OFF

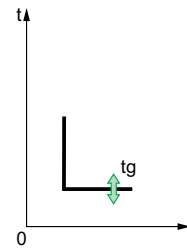

Adjusting Protection Settings Using the Keypad

To adjust the settings of the long-time, short-time, and instantaneous protection functions, refer to *MicroLogic 5.0 P settings*, page 51.

To adjust the settings of the ground-fault protection function:

1. Select  > **Current protection** > $I_{\leq} (A)$.

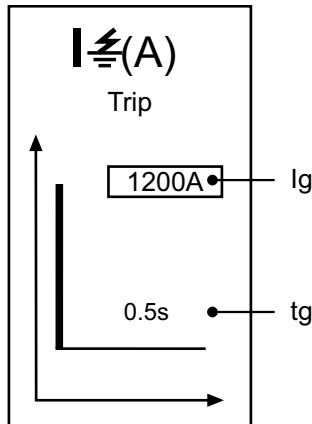

2. Use the buttons below the display screen to select, confirm, and save the settings, page 20.

Setting MicroLogic 7.0 P Trip Unit

You can set the tripping curve of your MicroLogic 7.0 A trip unit to match the needs of your installation using the following parameters:

1. Long-time current setting I_r
2. Long-time time delay t_r
3. Short-time pickup I_{sd}
4. Short-time time delay t_{sd}
5. Instantaneous pickup I_i
6. Earth-leakage pickup $I_{\Delta n}$
7. Earth-leakage time delay Δt

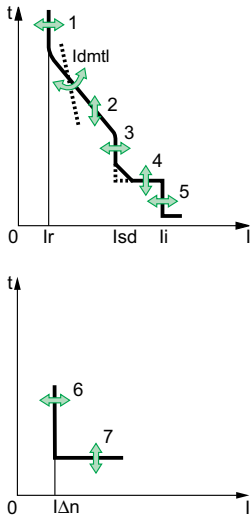

Set the Threshold Values Using the Dials

In this example, the rated current I_n of the circuit breaker is 2000 A.

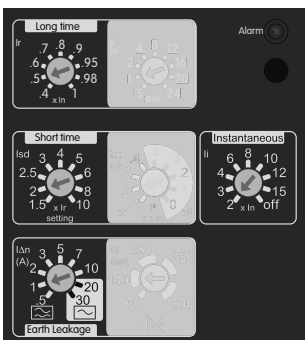

- $I_n = 2000 \text{ A}$
- $I_r = 0.5 \times I_n = 1000 \text{ A}$
- $I_{sd} = 2 \times I_r = 2000 \text{ A}$
- $I_i = 2 \times I_n = 4000 \text{ A}$
- $I_{\Delta n} = 1 \text{ A}$

Tripping curve with I^2t short-time ON

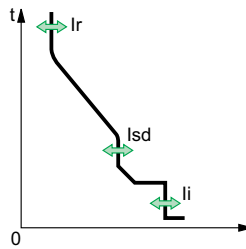

Tripping curve with I^2t short-time OFF

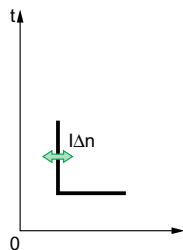
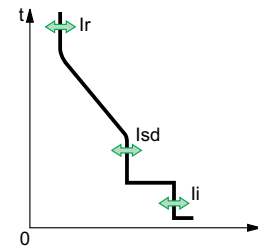

Set the Time Delays Using the Dials

In this example, time delay t_r of the circuit breaker is 1 second, time delay t_{sd} is 0.2 seconds with I^2t short-time ON and time delay $\Delta t = 140$ milliseconds

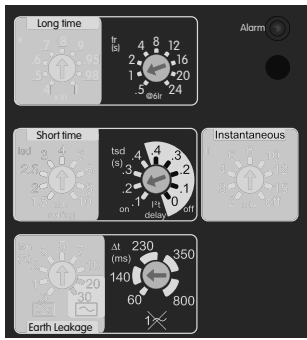

Tripping curve with I²t short-time ON

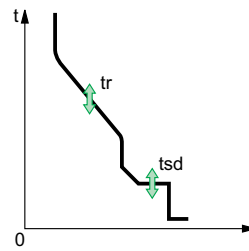

Tripping curve with I²t short-time OFF

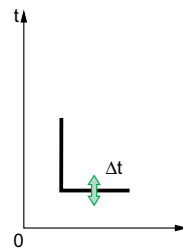
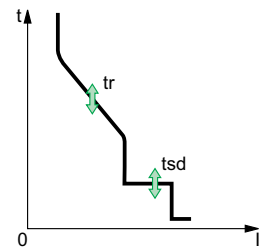

Adjusting Protection Settings Using the Keypad

To adjust the settings of the long-time, short-time, and instantaneous protection functions, refer to MicroLogic 5.0 P settings, page 51.

To adjust the settings of the earth-leakage protection function:

1. Select > **Current protection** > **I_{Δt} (A)**.

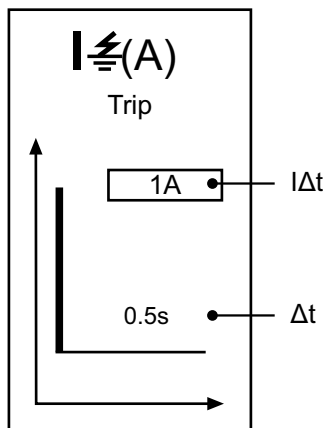

2. Use the buttons below the display screen to select, confirm, and save the settings, page 20.

Setting the Neutral Protection

Selecting the Type of Neutral Protection Using the Dial

On four-pole circuit breakers, it is possible to select the type of neutral protection for the fourth pole using the three-position dial on the ComPacT NS circuit breaker:

- Neutral unprotected (4P 3D)

NOTE: With the 4P 3D setting, the current in the neutral must not exceed the rated current of the circuit breaker.

- Neutral protection at $0.5 I_n$ (3D + N/2, factory setting)
- Neutral protection at I_n (4P 4D)

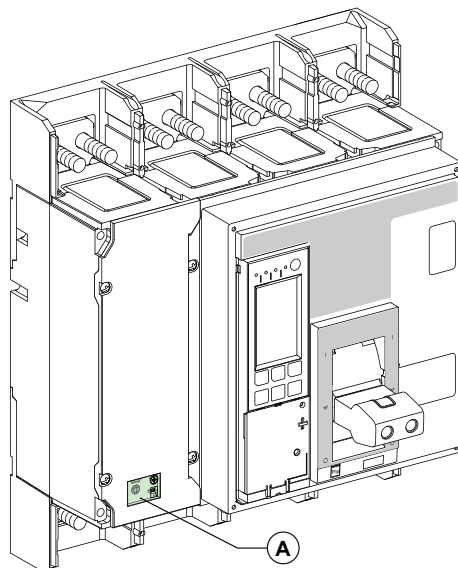

A. Cover for neutral protection three-position dial.

Follow these steps to set the type of neutral protection.

1. Remove the cover of the switch.

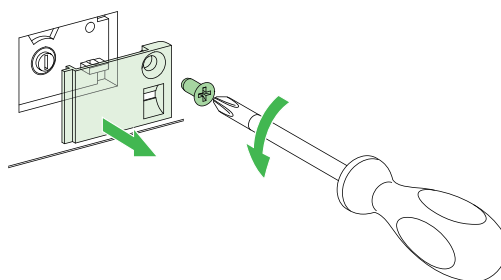

2. Select the protection type.

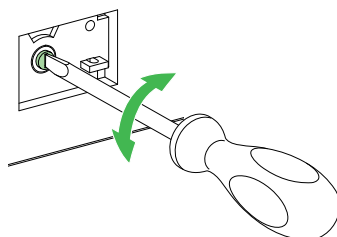

3. Put the cover back in place.

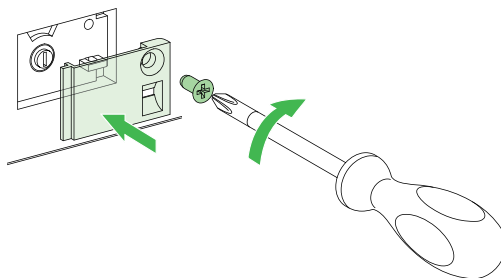

Setting the Neutral Protection Using the Keypad

1. Select  > **Current protection** > **Ineutral (A)**.

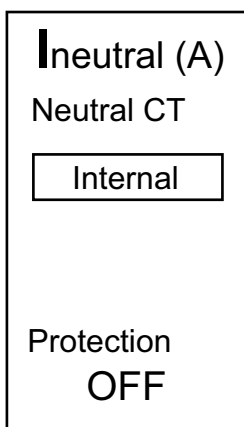

2. Use the buttons below the display screen to select the neutral CT used by the neutral protection:

- **None** disables the neutral protection.
- **Internal** for four-pole circuit breakers with internal neutral CT.
- **External** for three-pole circuit breakers connected to an external neutral CT.

3. Use the buttons below the display screen to set the neutral protection type.

Circuit breaker type	Neutral protection type
Four-pole	OFF: no neutral protection N/2: half neutral protection N: full neutral protection
Three-pole	OFF: no neutral protection N/2: half neutral protection N: full neutral protection 1.6 x N: oversized neutral protection

NOTE: On four-pole circuit breakers, setting of the neutral protection type using the keypad is limited by the dial setting.





Setting Additional Protection Functions

The following additional protection functions are set only using the keypad:

- Current unbalance
- Voltage unbalance
- Undervoltage
- Overvoltage
- Reserve power
- Under frequency
- Over frequency

Setting Procedure Using the Keypad

1. Select the corresponding menu:

-  > **Current protection.**
 - I  Alarm
 - I unbal (%)
 - $\overline{I1}$ max (A)
 - $\overline{I2}$ max (A)
 - $\overline{I3}$ max (A)
 - \overline{IN} max (A)
-  > **Voltage protection.**
 - U min (V)
 - U max (V)
 - U unbal (%)
-  > **Other protection.**
 - rP max (W)
 - F min (HZ)
 - F max (Hz)
 - Phase rotation

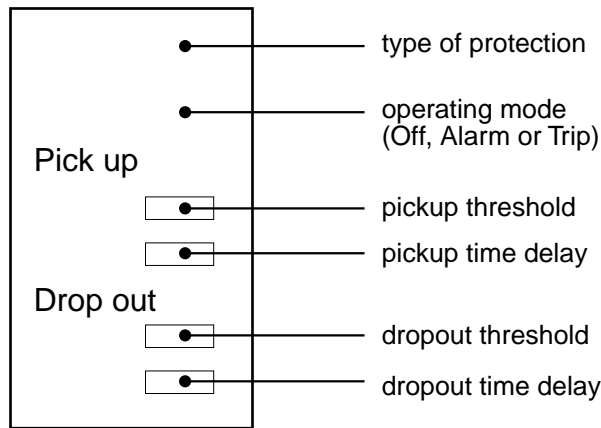

Specific case for I  alarm:

- Only the following choices are available:
 - On: activation of the alarm without fault tripping by the circuit breaker
 - Off: alarm disabled

2. Use the buttons below the display screen to select, confirm, and save the settings, page 20.

Example: Maximum Voltage Setting (U max)

1. Select operating mode, Off, Alarm or Trip.

<p style="text-align: center; font-size: 1.2em;">U_{max} (V)</p> <div style="border: 1px solid black; width: 100px; margin: 5px auto; text-align: center; padding: 2px;">Off</div> <p>Pick up</p> <p style="margin-left: 40px;">690V</p> <p style="margin-left: 40px;">5.00s</p> <p>Drop out</p> <p style="margin-left: 40px;">690V</p> <p style="margin-left: 40px;">0.50s</p>	<p style="text-align: center; font-size: 1.2em;">U_{max} (V)</p> <div style="border: 1px solid black; width: 100px; margin: 5px auto; text-align: center; padding: 2px;">Alarm</div> <p>Pick up</p> <p style="margin-left: 40px;">690V</p> <p style="margin-left: 40px;">5.00s</p> <p>Drop out</p> <p style="margin-left: 40px;">690V</p> <p style="margin-left: 40px;">0.50s</p>	<p style="text-align: center; font-size: 1.2em;">U_{max} (V)</p> <div style="border: 1px solid black; width: 100px; margin: 5px auto; text-align: center; padding: 2px;">Trip</div> <p>Pick up</p> <p style="margin-left: 40px;">690V</p> <p style="margin-left: 40px;">5.00s</p>
--	--	--

NOTE: In trip mode, the dropout threshold is equal to the pickup threshold.

The dropout time delay is fixed and equal to 1 second.

2. Set the pickup and dropout thresholds and time delays.

U_{max} (V)

Alarm

Pick up

690V

5.00s

Drop out

690V

0.50s

NOTE: For protection tripped by a maximum value, the dropout threshold is always less than or equal to the pickup threshold.

For protection tripped by a minimum value, the dropout threshold is always greater than or equal to the pickup threshold.

If both the minimum and maximum protection values are activated, the minimum threshold is automatically limited to the value of the maximum and vice versa.

3. When all the settings have been made, quit the screen by pressing one of the menu-access buttons.

Setting Load Shedding And Reconnection Function

The load shedding and reconnection function is set only using the keypad.

1. Select  > **Load shedding I** or > **Load shedding P**.

Load shedding P
<input type="text" value="Off"/>
Pick up
1000kW
3600s
Drop out
1000kW
10s

2. Use the buttons below the display screen to enable or disable the function:
 - Off: load shedding is disabled
 - On: load shedding is enabled
3. Use the buttons below the display screen:
 - To set the pickup threshold and time delay
 - To set the dropout threshold and time delay

For more information about the load shedding and reconnection function, see load shedding and reconnection, page 80.

Protection Functions of MicroLogic P Trip Unit

What's in This Part

Current Protection for MicroLogic P Trip Unit	63
Additional Protection for MicroLogic P Trip Unit.....	74

Current Protection for MicroLogic P Trip Unit

What's in This Chapter

Long-Time Protection	64
Short-Time Protection	67
Instantaneous Protection	68
Ground-Fault Protection on MicroLogic 6.0 P Trip Unit	70
Earth-Leakage Protection on MicroLogic 7.0 P Trip Unit	71
Neutral Protection	72

Long-Time Protection

The long-time protection function helps to protect cables against overloads. This function is based on true rms measurements.

It is possible to select either I²t long-time protection or Idmtl long-time protection.

Idmtl long-time protection proposes tripping curves with different slopes, used to improve:

- Discrimination with fuses positioned upstream (HV) and/or downstream
- Protection for certain types of loads

Five types of curve are available:

- DT: definite time curve
- SIT: standard inverse time curve (I^{0.5}t)
- VIT: very inverse time curve (It)
- EIT extremely inverse time curve (I²t)
- HVF: compatible with high-voltage fuses (I⁴t)

I²t long-time protection is selected by default.

Select Idmtl long-time protection by making fine adjustments to the long-time protection on the Idmtl (A) screen.

I²t long-time protection can be selected again by making fine adjustments to the long-time protection on the I (A) screen.

For the factory settings, the setting ranges, increment steps and setting accuracies, refer to [Threshold and Time-Delay Settings](#), page 114.

Long-Time Current Setting Ir

The Ir pickup setting values depend on the long-time rating plug inserted in the MicroLogic P trip unit. For more information, refer to [Long-time Rating Plug](#), page 104.

Ir pickup = setting value x In rated current. Tripping between 1.05 and 1.20 Ir.

As standard, trip units are equipped with the standard rating plug (0.4–1 x In).

Rating plug	Current setting								
Standard	0.4	0.5	0.6	0.7	0.8	0.9	0.95	0.98	1
Low-setting option	0.4	0.45	0.50	0.55	0.60	0.65	0.70	0.75	0.8
High-setting option	0.80	0.82	0.85	0.88	0.90	0.92	0.95	0.98	1
Off-plug	No long-time overcurrent protection (Ir = In for Isd setting)								

NOTE: The long-time rating plug must always be removed, page 104 before carrying out insulation or dielectric withstand tests.

When the current is higher than Isd or Ii, only short-time overcurrent protection and instantaneous protection are operational.

I²t Tripping Time

The tr time delay settings indicated on the rating plugs correspond to the tripping times for an overload of 6 x Ir in cold-state conditions.

The table below gives tripping times according to tr time delay for long-time protection with I²t tripping curve.

Tripping time (s)	Accuracy	tr time delay									
		0.5 s	1 s	2 s	4 s	8 s	12 s	16 s	20 s	24 s	
at 1.5 x Ir	0 to -30%	12.5	25	50	100	200	300	400	500	600	
at 6 x Ir	0 to -20%	0.7 ¹	1	2	4	8	12	16	20	24	
at 7.2 x Ir	0 to -20%	0.7 ²	0.69	1.38	2.7	5.5	8.3	11	13.8	16.6	

Idmtl Tripping Time

The tr time delay settings indicated on the rating plugs correspond to the tripping times for an overload of 6 x Ir in cold-state conditions.

The table below gives tripping times according to tr time delay for long-time protection with Idmtl tripping curve.

Tripping curve	Tripping time (s)	Accuracy	tr time delay									
			0.5 s	1 s	2 s	4 s	8 s	12 s	16 s	20 s	24 s	
DT	at 1.5 x Ir	0 to -20%	0.53	1	2	4	8	12	16	20	24	
	at 6 x Ir	0 to -20%	0.53	1	2	4	8	12	16	20	24	
	at 7.2 x Ir	0 to -20%	0.53	1	2	4	8	12	16	20	24	
	at 10 x Ir	0 to -20%	0.53	1	2	4	8	12	16	20	24	
SIT	at 1.5 x Ir	0 to -30%	1.9	3.8	7.6	15.2	30.4	45.5	60.7	75.8	91	
	at 6 x Ir	0 to -20%	0.5	1	2	4	8	12	16	20	24	
	at 7.2 x Ir	0 to -20%	0.7 ¹	0.88	1.77	3.54	7.08	10.6	14.16	17.7	21.2	
	at 10 x Ir	0 to -20%	0.7 ²	0.8	1.43	2.86	5.73	8.59	11.46	14.33	17.19	
VIT	at 1.5 x Ir	0 to -30%	3.6	7.2	14.4	28.8	57.7	86.5	115.4	144.2	173.1	
	at 6 x Ir	0 to -20%	0.5	1	2	4	8	12	16	20	24	
	at 7.2 x Ir	0 to -20%	0.7 ¹	0.81	1.63	3.26	6.52	9.8	13.1	16.34	19.61	
	at 10 x Ir	0 to -20%	0.7 ²	0.75	1.14	2.28	4.57	6.86	9.13	11.42	13.70	
EIT	at 1.5 x Ir	0 to -30%	12.5	25	50	100	200	300	400	500	600	
	at 6 x Ir	0 to -20%	0.7 ¹	1	2	4	8	12	16	20	24	
	at 7.2 x Ir	0 to -20%	0.7 ²	0.69	1.38	2.7	5.5	8.3	11	13.8	16.6	
	tr at 10 x Ir	0 to -20%	0.7 ²	0.7 ¹	0.7 ¹	1.41	2.82	4.24	5.45	7.06	8.48	
HVF	at 1.5 x Ir	0 to -30%	164.5	329	658	1316	2632	3950	5265	6581	7900	
	at 6 x Ir	0 to -20%	0.7 ¹	1	2	4	8	12	16	20	24	
	at 7.2 x Ir	0 to -20%	0.7 ²	0.7 ¹	1.1 ¹	1.42	3.85	5.78	7.71	9.64	11.57	
	at 10 x Ir	0 to -20%	0.7 ²	0.7 ²	0.7 ¹	0.7 ¹	1.02	1.53	2.04	2.56	3.07	

Thermal Memory

- The thermal memory, page 113 continuously accounts for the amount of heat in the cables, both before and after tripping, whatever the value of the current (presence of an overload or not). The thermal memory optimizes the long-time protection function of the circuit breaker by taking into account the temperature rise in the cables.
- The thermal memory assumes a cable cooling time of approximately 15 minutes.

Neutral Protection

Overload protection (long time) for the neutral is disabled if the Idmtl protection function is selected. However, the short-circuit protection (short-time and instantaneous) remains operational.

1. Accuracy: 0 to -40%
2. Accuracy: 0 to -60%

Intermittent Overloads

As long as the MicroLogic P trip unit remains supplied with power, the effects of intermittent overloads on cables are calculated. If power is cut, temperature rise in cables is not calculated.

Circuit Breaker Thermal Limit

For certain settings, the Idmtl curves may be limited by the I²t curve when the time delay tr is set to 24 seconds or by its thermal memory. The maximum I²t curve remains active for the phases and the neutral even when the Idmtl curves are activated.

Short-Time Protection

- The short-time protection function helps to protect the distribution system against impedant short-circuits.
- This function carries out true rms measurements.
- The short-time time delay and the I²t ON and I²t OFF options can be used to obtain selectivity with a downstream circuit breaker:
 - I²t OFF selected: the protection function implements a constant time curve.
 - I²t ON selected: the protection function implements an I²t inverse-time curve up to 10 I_r. Above 10 I_r, the time curve is constant.
- Zone selective interlocking (ZSI).

The short-time and ground-fault protection functions enable time selectivity by delaying the upstream devices to provide the downstream devices the time required to clear the fault. Zone selective interlocking can be used to obtain total selectivity between circuit breakers using external wiring.

For the characteristics and external wiring of the zone selective interlocking function, refer to Zone Selective Interlocking, page 107 in the technical appendix.

- Intermittent faults are taken into account by the trip unit and may lead to shorter tripping times than those set.
- For the factory settings, the setting ranges, increment steps and setting accuracies, refer to Threshold and Time-Delay Settings, page 114.

Short-Time Pick-Up I_{sd}

Pickup (accuracy ± 10%)	I _{sd} = I _r x ...	1.5	2	2.5	3	4	5	6	8	10
-------------------------	--	-----	---	-----	---	---	---	---	---	----

Time Delay t_{sd}

tsd time delay (s)	I ² t OFF	0	0.1	0.2	0.3	0.4
	I ² t ON		0.1	0.2	0.3	0.4
Tripping time at 10 x I _r (ms) with I ² t ON or I ² t OFF	Maximum resettable time	20	80	140	230	350
	Maximum break time	80	140	200	320	500

If the rating plug without long-time protection is used and the long-time protection function is disabled, the short-time pickup I_{sd} is automatically multiplied by I_n instead of I_r as is the standard case.

Instantaneous Protection

- The instantaneous-protection function protects the distribution system against solid short circuits. Contrary to the short-time protection function, the time delay for instantaneous protection is not adjustable.

The tripping order is sent to the circuit breaker as soon as current exceeds the set value, with a fixed time delay of 20 milliseconds.

- This function carries out true rms measurements.
- The energy reduction maintenance setting (ERMS) function is added to the instantaneous protection function by addition of an optional IO module to the IMU configured to perform the pre-defined application 3 or the ERMS user-defined application.

For more information, refer to IO Input/Output Interface for LV circuit breaker user guide.

- For the factory settings, the setting ranges, increment steps and setting accuracies, refer to Threshold and Time-Delay Settings, page 114.

Instantaneous Pick-Up Ii

Pick-up (accuracy $\pm 10\%$)	I _{sd} = I _n x ...	2	3	4	6	8	10	12	15	OFF
--------------------------------	--	---	---	---	---	---	----	----	----	-----

Circuit breakers have two types of instantaneous protection:

- Adjustable instantaneous protection Ii
- Self-protection

Depending on the circuit breaker, the OFF position corresponds to the self-protection pickup.

Energy Reduction Maintenance Settings (ERMS) Function

DANGER

HAZARD OF ARC FLASH

- Do not change the settings of MicroLogic P trip unit while in ERMS mode,
- Seal the transparent cover of the MicroLogic P trip unit when using the ERMS mode.

Failure to follow these instructions will result in death or serious injury.

The energy reduction maintenance setting (ERMS) function is available on circuit breaker fitted with:

- A BCM ULP with firmware version 4.1.0 and above.
- A MicroLogic P trip unit:
 - With firmware version Plogic-2014AN and above.
 - With hardware compatible with the ERMS function. Use the customer engineering tool to check the MicroLogic hardware version, or the COM option to check that the hardware version coded in register 8709 is equal to 0x1000.

The ERMS function allows the selection of the MicroLogic trip unit settings: Normal and ERMS mode.

The ERMS function is used to reduce the Ii protection settings in order to trip as fast as possible when a fault occurs. The factory setting for Ii protection in ERMS mode is 2 x I_n. This protection parameter can be modified using the customer engineering tool.

If any of the basic protection settings using the rotary dial is modified on the MicroLogic trip unit while in ERMS mode, the MicroLogic trip unit switches

immediately to the normal mode. The MicroLogic trip unit returns automatically to the ERMS mode after 5 seconds.

The selection of the normal or ERMS mode is made by a selector switch connected to two inputs of the IO module.

When the ERMS mode is engaged, **ERMS** is shown on the display of the MicroLogic trip unit and a pilot light connected to the output O3 of the IO module will be in ON state.

NOTE: ERMS may be activated after a short delay due to internal controls in the system. Ensure that the Output 3 (O3) of IO module is ON and MicroLogic HMI displays ERMS before operating the equipment.

The locking pad of the communication interface module (IFM or IFE) must be in UNLOCK position (padlock open) while performing the energy reduction maintenance setting (ERMS).

The parameter **Access permit** in the **COM setup/Remote setting** menu on the display of the MicroLogic trip unit must be set to YES for IMU without IFM/IFE.

This is based on the following behavior:

- IMU with IFM/IFE
 - Setting **Access permit** parameter: The **Access permit** parameter can be changed only from IFM/IFE using the LOCK/UNLOCK dial.
 - Behavior: ERMS ON and OFF orders are executed even if **Access permit** parameter is set as NO.
- IMU without IFM/IFE
 - Setting **Access permit** parameter: The **Access permit** parameter can be changed only from the display of the MicroLogic trip unit.
 - Behavior: ERMS ON and OFF orders are not executed if **Access permit** parameter is set as NO.

NOTE: The ERMS ON and OFF orders are executed only when the access parameter is set to YES and the passcode in the MicroLogic trip unit must be set to 0000.

If the ERMS function or COM option is used, it is advisable to connect a second dedicated power supply to the F1-/F2+ terminals to supply the MicroLogic P trip unit.

For more information, refer to *Power Supply*, page 110.

MicroLogic display with **ERMS** mode engaged

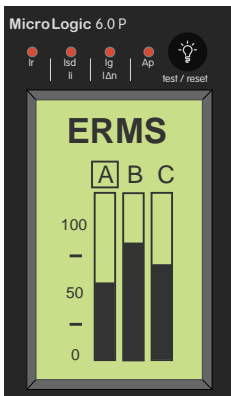

Ground-Fault Protection on MicroLogic 6.0 P Trip Unit

- A ground fault in the protection conductors can provoke local temperature rise at the site of the fault or in the conductors.

The purpose of the ground-fault protection function is to eliminate this type of fault.

- There are two types of ground-fault protection, depending on the type of installation.

Type	Description
Residual	<ul style="list-style-type: none"> ◦ The function determines the zero-phase sequence current, i.e. the vector sum of the phase and neutral currents. It detects ground faults downstream of the circuit breaker.
Source Ground Return	<ul style="list-style-type: none"> ◦ Using a special external sensor, this function directly measures the fault current returning to the transformer via the grounding cable. ◦ It detects ground faults both upstream and downstream of the circuit breaker. ◦ The maximum distance between the sensor and the circuit breaker is 10 m (33 ft).

- Ground-fault and neutral protection are independent and can therefore be combined.
- Zone selective interlocking (ZSI).

The short-time and ground-fault protection functions enable time selectivity by delaying the upstream devices to provide the downstream devices the time required to clear the fault. Zone selective interlocking can be used to obtain total selectivity between circuit breakers using external wiring.

For the characteristics and external wiring of the zone selective interlocking function, refer to [Zone Selective Interlocking](#), page 107 in the technical appendix.

- For the factory settings, the setting ranges, increment steps and setting accuracies, refer to [Threshold and Time-Delay Settings](#), page 114.

Ground-Fault Pick-Up I_g

The pickup values can be set independently and are identical for both the residual and source ground return ground-fault protection functions.



I _g pickup (accuracy ± 10%)	I _n ≤ 400 A	I _g = I _n X...	A	B	C	D	E	F	G	H	I
			0.3	0.3	0.4	0.5	0.6	0.7	0.8	0.9	1
	400 A < I _n ≤ 1200 A	I _g = I _n X...	0.2	0.3	0.4	0.5	0.6	0.7	0.8	0.9	1
	I _n > 1200 A	I _g = ...	500 A	640 A	720 A	800 A	880 A	960 A	1040 A	1120 A	1200 A

Time Delay t_g

The time delay t_g can be set independently and is identical for both the residual and source ground return ground-fault protection functions.

t _g time delay (s)	I ² t OFF	0	0.1	0.2	0.3	0.4
	I ² t ON	0.1	0.2	0.3	0.4	—
Tripping time (ms) at I _n or 1200 A with I ² t ON or I ² t OFF	Maximum resettable time	20	80	140	230	350
	Maximum break time	80	140	200	320	500

Earth-Leakage Protection on MicroLogic 7.0 P Trip Unit

- The earth-leakage protection function primarily helps to protect people against indirect contact because an earth-leakage current can provoke an increase in the potential of the exposed conductive parts.
- The earth-leakage pick-up value $I\Delta n$ is displayed directly in amperes and the time delay follows a constant-time curve.
- An external rectangular sensor is required for this function.
- This function is inoperative if the long-time rating plug is not installed.
-  As a type-AC, the circuit breaker is protected against nuisance tripping.
-  As a type-A, the circuit breaker provides DC-component withstand up to 10 A.
- If the optional external voltage-measurement input is used, a 24 Vdc external power supply must be connected to the F1-/ F2+ terminals, see Power Supply, page 110.
- For the factory settings, the setting ranges, increment steps and setting accuracies, see Threshold and Time-Delay Settings, page 114.

Pick-Up Value $I\Delta n$

$I\Delta n$ pickup (A) (accuracy 0 to - 20%)	0.5	1	2	3	5	7	10	20	30
--	-----	---	---	---	---	---	----	----	----

Time Delay Δt

Δt time delay (ms) (Maximum resettable time)	60	140	230	350	800
Δt Maximum break time (ms)	140	200	320	500	1000

Neutral Protection

Three-Pole Circuit Breakers

Protection of the neutral is possible on a three-pole circuit breaker by connecting an external sensor.

For more information about the setting procedure, refer to [Setting Neutral Protection](#), page 56.

MicroLogic trip unit	5.0 P, 6.0 P and 7.0 P			
Setting	OFF (factory setting)	N/2	N	1.6xN

Protection setting	Description
OFF: Neutral unprotected	The distribution system does not require protection of the neutral conductor.
N/2: Half neutral protection	<p>The cross-sectional area of the neutral conductor is half that of the phase conductors.</p> <ul style="list-style-type: none"> The long-time current setting I_r for the neutral is equal to half the setting value. The short-time pick-up I_{sd} for the neutral is equal to half the setting value. The instantaneous pick-up I_i for the neutral is equal to the setting value. For ground-fault protection (MicroLogic 6.0 P), pickup I_g for the neutral is equal to the setting value.
N: Full neutral protection	<p>The cross-sectional area of the neutral conductor is equal to that of the phase conductors.</p> <ul style="list-style-type: none"> The long-time current setting I_r for the neutral is equal to the setting value. The short-time pick-up I_{sd} for the neutral is equal to the setting value. The instantaneous pick-up I_i for the neutral is equal to the setting value. For ground-fault protection (MicroLogic 6.0 P), pickup I_g for the neutral is equal to the setting value.
1.6xN: Oversized neutral protection	<p>In installations with a high level of third-order harmonic currents (or multiples thereof), the current in the neutral conductor may exceed that of the phase currents under steady-state conditions</p> <ul style="list-style-type: none"> The long-time current setting I_r for the neutral is 1.6 times that of the setting value. The short-time pick-up I_{sd} for the neutral is 1.6 times that of the setting value, but may not exceed $10 I_n$ to limit transients and self-protect the installation. The instantaneous pick-up I_i for the neutral is equal to the setting value. For ground-fault protection (MicroLogic 6.0 P), pickup I_g for the neutral is equal to the setting value.

Four-Pole Circuit Breakers

For more information about the setting procedure, refer to [Setting Neutral Protection](#), page 56.

MicroLogic trip unit	5.0 P, 6.0 P and 7.0 P		
Setting	OFF	N/2 (factory setting)	N

Protection setting	Description
OFF: Neutral unprotected	The distribution system does not require protection of the neutral conductor.
N/2: Half neutral protection	<p>The cross-sectional area of the neutral conductor is half that of the phase conductors.</p> <ul style="list-style-type: none">• The long-time current setting I_r for the neutral is equal to half the setting value.• The short-time pick-up I_{sd} for the neutral is equal to half the setting value.• The instantaneous pick-up I_i for the neutral is equal to the setting value.
N: Full neutral protection	<p>The cross-sectional area of the neutral conductor is equal to that of the phase conductors.</p> <ul style="list-style-type: none">• The long-time current setting I_r for the neutral is equal to the setting value.• The short-time pick-up I_{sd} for the neutral is equal to the setting value.• The instantaneous pick-up I_i for the neutral is equal to the setting value.

Additional Protection for MicroLogic P Trip Unit

What's in This Chapter

Additional Current Protection Functions	74
Voltage Protection Functions	76
Other Protection Functions.....	78
Load Shedding and Reconnection	80

Additional Current Protection Functions

The following additional current protection functions are available with the MicroLogic P trip unit:

- Ground-fault alarm
- Current unbalance
- Maximum current

The additional current protection functions are set using the keypad, page 59. The settings are listed in Threshold and Time-Delay Settings, page 114.

Operating Principle

Protection tripped by a maximum value

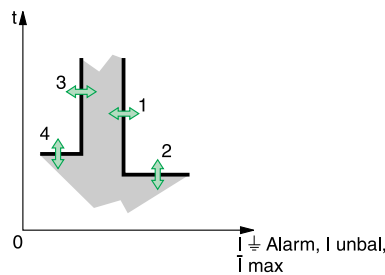

1. pickup threshold
2. pickup time delay
3. dropout threshold
4. dropout time delay

- For protection tripped by a maximum value, it is possible to set
 - A pickup threshold (1) that activates an alarm, a contact and/or tripping.
 - A pickup time delay (2) that steps in when the pickup threshold (1) is reached.
 - A dropout threshold (3) corresponding to deactivation of the alarm and/or contact.
 - A dropout time delay (4) that steps in when the dropout threshold (3) is reached.
- The dropout threshold is always less than or equal to the pickup threshold.

Ground-Fault Alarm I

- The ground-fault alarm function uses the rms value of the ground-fault current.

NOTE: On MicroLogic 7.0 trip units, the alarm is called earth-leakage alarm, and uses the earth-leakage current.

- This alarm signals a ground-fault or earth-leakage current above the pickup value and does not trip the circuit-breaker.

Current-Unbalance Protection I_{unbal}

This protection is activated by an adjustable level of unbalance between the rms values of the three phase currents.

This function calculates the rms value of the unbalance between the three phase currents.

$$I_{unbal} = |E_{max}| / I_{avg}$$

Where:

- I_{avg} is the average value of the rms currents of the three phases

$$I_{avg} = (I_1 + I_2 + I_3) / 3$$
- E_{max} is the maximum difference between the current of each phase and I_{avg} .

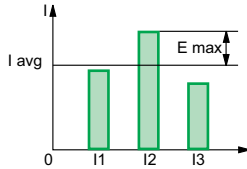

Maximum-Current Protection Per Phase I_{max}

- Protection values may be set for each of the following currents:
 - $\overline{I_1}$ max: maximum current on phase 1
 - $\overline{I_2}$ max: maximum current on phase 2
 - $\overline{I_3}$ max: maximum current on phase 3
 - $\overline{I_N}$ max: maximum current in the neutral
- This function calculates the rms demand value of the current for the given phase ($\overline{I_1}$, $\overline{I_2}$, $\overline{I_3}$) or the neutral ($\overline{I_N}$), over a sliding time interval.

The time interval is the same as that for the calculation of the demand currents in the **Metering** menu.

Settings are made in the **Metering setup** menu.

NOTE: $\overline{I_N}$ max protection does not take into account the neutral-protection setting (N, N/2, 1.6xN, OFF).

Voltage Protection Functions

The following voltage protection functions are available with the MicroLogic P trip unit.

- Minimum voltage
- Maximum voltage
- Voltage unbalance

The voltage protection functions are set using the keypad, page 59. The settings are listed in Threshold and Time-Delay Settings, page 114.

Operating Principle

Protection tripped by a minimum value

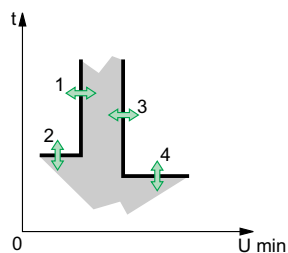

Protection tripped by a maximum value

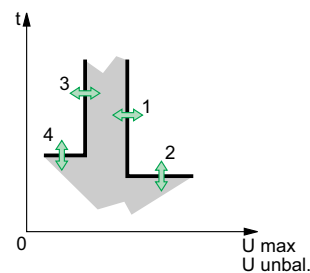

1. Pickup threshold
2. Pickup time delay
3. Dropout threshold
4. Dropout time delay

- For protection tripped by a minimum or maximum value, it is possible to set:
 - A pickup threshold (1) that activates an alarm, a contact and/or tripping.
 - A pickup time delay (2) that steps in when the pickup threshold (1) is reached.
 - A dropout threshold (3) corresponding to deactivation of the alarm and/or contact.
 - A dropout time delay (4) that steps in when the dropout threshold (3) is reached.
- For protection tripped by a minimum value, the dropout threshold is always greater than or equal to the pickup threshold.
- For protection tripped by a maximum value, the dropout threshold is always less than or equal to the pickup threshold.
- If both the minimum and maximum protection functions are activated at the same time, the minimum threshold is automatically limited to the value of the maximum and vice versa.

Minimum-Voltage Protection U_{min}

- This function calculates the minimum rms value of the three phase-to-phase voltages.
- Protection is activated when at least one of the three phase-to-phase voltages (U_{12} , U_{23} , U_{31}) is below the threshold set by the user.
- This protection function does not detect phase failure.

NOTE: If the voltage protection functions are activated and the voltage measurement inputs are still energized, it is impossible to reset and close the circuit breaker.

Maximum-Voltage Protection U_{max}

- This function calculates the maximum rms value of the three phase-to-phase voltages.
- Protection is activated when the three phase-to-phase voltages (U_{12} , U_{23} , U_{31}) are simultaneously above the threshold set by the user.

Voltage-Unbalance Protection U_{unbal}

This protection is activated by an adjustable level of unbalance between the rms values of the three phase-to-phase voltages.

This function calculates the rms value of the unbalance between the three phase-to-phase voltages.

$$U_{unbal} = |E_{max}|/U_{avg}$$

Where:

- U_{avg} is the average value of the rms voltages of the three phases.
$$U_{avg} = (U_{12} + U_{23} + U_{31})/3$$
- E_{max} is the maximum difference between the voltage of each phase and U_{avg} .

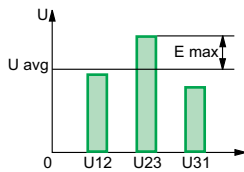

Other Protection Functions

The following other protection functions are available with the MicroLogic P trip unit.

- Reverse power
- Minimum frequency
- Maximum frequency
- Phase rotation

The other protection functions are set using the keypad, page 59. The settings are listed in Threshold and Time-Delay Settings, page 114.

Operating Principle

Protection tripped by a minimum value

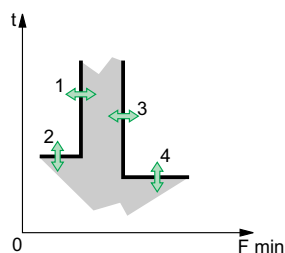

Protection tripped by a maximum value

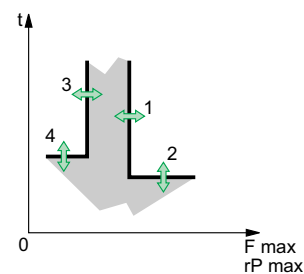

1. pickup threshold
 2. pickup time delay
 3. dropout threshold
 4. dropout time delay
- For protection tripped by a minimum or maximum value, it is possible to set:
 - A pickup threshold (1) that activates an alarm, a contact and/or tripping.
 - A pickup time delay (2) that steps in when the pickup threshold (1) is reached.
 - A dropout threshold (3) corresponding to deactivation of the alarm and/or contact.
 - A dropout time delay (4) that steps in when the dropout threshold (3) is reached.
 - For protection tripped by a minimum value, the dropout threshold is always greater than or equal to the pickup threshold.
 - For protection tripped by a maximum value, the dropout threshold is always less than or equal to the pickup threshold.
 - If both the minimum and maximum protection functions are activated at the same time, the minimum threshold is automatically limited to the value of the maximum and vice versa.

Reverse-Power Protection rP Max

- This function calculates the value of the total active power on the three phases.
- The function is activated when the total active power of the three phases flows in the direction opposite to the one set by the user and is greater than the pickup threshold (1) for a time greater than the time delay (2).

NOTE: The direction of flow is set by the user in the **Power sign** section of the MicroLogic setup menu under **History, maintenance and settings**.

- + corresponds to the normal direction of flow, i.e. from the top terminals on the circuit breaker to the bottom terminals.
- - is the opposite.

Minimum and Maximum-Frequency Protection F min and F max

These functions monitor the value of the frequency on the distribution system.

NOTE: If the voltage protection functions are activated and the voltage measurement inputs are still energized, it is impossible to reset and close the circuit breaker.

Phase-Rotation Alarm

This alarm is activated if two of the three phases are inverted.

NOTE: The alarm is activated following a fixed 300 millisecond time delay. If one of the phases is absent, the alarm will not operate. If the 400 Hz frequency is set, the alarm cannot be activated.

Load Shedding and Reconnection

The load shedding and reconnection function is set using the keypad, see [Setting Load Shedding and Reconnection Function](#), page 61. The settings are listed in [Threshold and Time-Delay Settings](#), page 114.

Load Shedding and Reconnection Depending on Current

The pickup curve for load shedding and reconnection depending on current is parallel to the I^2t and I_{dmtl} long-time curves. If a rating plug without long-time protection is installed, the load shedding and reconnection function based on current cannot be activated.

- I^2t long-time protection: the neutral is taken into account.
- I_{dmtl} long-time protection: the neutral is not taken into account.

The function does not trip the circuit breaker. It can be used to disconnect and reconnect non-priority loads by triggering an alarm linked to:

- Outputs of the IO module
- The communication option

The load-shedding and reconnection function is determined by thresholds and time delays.

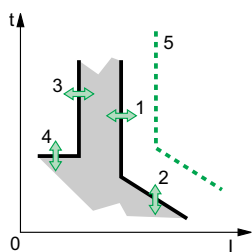

1. pickup threshold
2. pickup time delay
3. dropout threshold
4. dropout time delay
5. long-time protection curve

The pickup threshold is always greater than or equal to the dropout threshold.

Load Shedding and Reconnection Depending on Power

Load shedding and reconnection depending on power calculates the total active power on the three phases. The function does not trip the circuit breaker. It can be used to disconnect and reconnect non-priority loads by triggering an alarm linked to:

- Outputs of the IO module
- The communication option

The load-shedding and reconnection function is determined by thresholds and time delays.

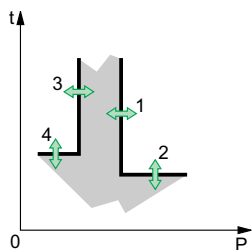

1. pickup threshold
2. pickup time delay
3. dropout threshold
4. dropout time delay

The pickup threshold is always greater than or equal to the dropout threshold.

Other Functions of MicroLogic P Trip Unit

What's in This Part

Measurements	82
Alarms	86
Event Histories	88
Operation Counter and Contact Wear Indicator.....	89
Communication Function	90

Measurements

What's in This Chapter

Current and Voltage.....	82
Power, Energy, and Frequency	84

Current and Voltage

Instantaneous Current

MicroLogic P trip units offer two, non-exclusive measurement possibilities.

- On the bar graph displayed on the default screen
 - The instantaneous current of the most heavily loaded phase is automatically displayed in amperes for phases 1, 2, 3 and the neutral (depending on the neutral protection settings). The bar graph indicates the percent load of the three phases.
- In the I inst. section of the instantaneous currents
 - Display in amperes of the instantaneous currents I (rms) on phases I1, I2 and I3 and the neutral current IN, the ground-fault current Ig (MicroLogic 6.0 P), the earth-leakage current IΔn (MicroLogic 7.0 P)
 - The maximum instantaneous currents are displayed and stored in memory.
 - The stored maximums can be reset at any time.

NOTE: For the measurement ranges and accuracies, see Measurement Ranges and Accuracy, page 119 .

Demand Current

- Display of the demand current on phases $\overline{I1}$, $\overline{I2}$, $\overline{I3}$ and the neutral \overline{IN} (depending on the type of distribution system)
- Selection of the demand calculation method
- Display of the interval over which the value is calculated
- The maximum demand values are displayed and stored in memory
- The stored maximums can be reset at any time.

NOTE: The calculation method, the type of calculation window (fixed or sliding) and its duration may be set in the **Metering setup** menu under **History, maintenance and setup**.

Phase-to-Neutral and Phase-to-Phase Voltages

The MicroLogic P trip unit offers different voltage measurements:

- Phase-to-phase voltages (rms) between phases U12, U23 and U31, displayed in volts
- Phase-to-neutral voltages (rms) between the phases and the neutral V1N, V2N and V3N, displayed in volts.

NOTE: To display the phase-to-neutral voltages, select the **3Φ 4F4CT** option in **System type** in the **Metering setup** menu under **History, maintenance and setup**.

For more information about voltage measurement inputs, refer to Selection of the Voltage-Measurement Inputs, page 103.

The supply circuit of the voltage-measurement input is reserved exclusively for the trip unit and must never be used to supply other circuits.

Average Voltage

Average U avg of the instantaneous voltages between phases U12, U23 and U31.

Phase Rotation

Display of the phase sequence.

Voltage Unbalance

Display of the unbalance U unbal between the three phase-to-phase voltages, displayed as a percentage.

Power, Energy, and Frequency

Instantaneous Power and Power Factor

The MicroLogic P trip unit offers a number of different measurements.

- Total power measurements:
 - Instantaneous active power P in kW
 - Instantaneous reactive power Q in kvar
 - Instantaneous apparent power S in kVA
- Measurement of the power factor PF

To ensure reliable power and power-factor measurements, the **Power sign** and **Sign convention** parameters must be set.

NOTE: For the measurement ranges and accuracies, see [Measurement Ranges and Accuracy](#), page 119 .

Demand Power

- Display of the demand values for the active power P, reactive power Q and apparent power S
- Selection of the demand calculation method
- Display of the interval over which the value is calculated
- The maximum demand values are displayed and stored in memory.
- The stored maximums can be reset at any time.

NOTE:

- The calculation method, the type of calculation window (fixed or sliding) and its duration may be set in the **Metering setup** menu under **History, maintenance and setup**.
- The synchronisation function (Synchro.Com) is available only with the COM communication option. With this function, the demand power is determined on the basis of a signal synchronized by the communication module.
- These settings apply to all demand powers (active power P, reactive power Q and apparent power S). If the settings are modified, the demand values are systematically recalculated.

Energy

The MicroLogic P trip unit offers a number of different measurements.

- Total energy:
 - Total active energy E.P in kWh
 - Total reactive energy E.Q in kvarh
 - Total apparent energy E.S in kVAh
- Energy consumed (Energy in), positively incremented:
 - Active energy E.P in kWh
 - Reactive energy E.Q in kvarh
- Energy supplied (Energy out), negatively incremented:
 - Active energy E.P in kWh
 - Reactive energy E.Q in kvarh
- Energy values can be reset.

NOTE:

- The Energy in and Energy out values are incremented according to the power sign set in the **Metering setup** menu under **History, maintenance and setup**.
- As standard, the total calculated energy values are **absolute total values**. They represent the sum of the energy in and out values:
 - $E.P = \Sigma E.P \text{ in} + \Sigma E.P \text{ out}$
 - $E.Q = \Sigma E.Q \text{ in} + \Sigma E.Q \text{ out}$
- As an option (access exclusively via the COM communications option), energy can be calculated algebraically:
 - $E.P = \Sigma E.P \text{ in} - \Sigma E.P \text{ out}$
 - $E.Q = \Sigma E.Q \text{ in} - \Sigma E.Q \text{ out}$

These values are called **signed** energies.

Frequency

The frequency of the distribution system is displayed in Hz.

Alarms



- An alarm may be viewed using:
 - The **Alarm history** menu.
 - The COM communications option.
- The commands in the **Protection** menu are used to attribute a specific operating mode to each of the protection functions:
 - OFF: protection disabled
 - Alarm: the function issues an alarm, but does not trip the circuit breaker.
 - Trip + Alarm: the function issues an alarm and trips the circuit breaker.
- The protection functions against overloads (long time), short circuits (short time and instantaneous) and ground faults (ground-fault and earth-leakage currents) automatically result in tripping and cannot be deactivated (Trip mode only).

Current protection	Off	Alarm	Trip + Alarm
I_r	–	–	✓
I_{sd} / I_i	–	–	✓
I_{\leq}	–	–	✓

- The I_{\leq} **Alarm** and phase rotation alarms can be set exclusively to OFF or Alarm mode.
- The other protection functions for current, voltage, power and frequency may be set to any of the three modes, OFF, Alarm or Trip + Alarm.
- The load shedding and reconnection function may be set to ON or OFF.

Current protection	Off	Alarm	Trip + Alarm
I_{\leq} Alarm	✓	✓	–
I_{unbal}	✓	✓	✓
\bar{I}_1	✓	✓	✓
\bar{I}_2	✓	✓	✓
\bar{I}_3	✓	✓	✓
\bar{I}_N	✓	✓	✓
Voltage protection	Off	Alarm	Trip + Alarm
U min	✓	✓	✓
U max	✓	✓	✓
U unbal	✓	✓	✓
Other protection	Off	Alarm	Trip + Alarm
rP max	✓	✓	✓
F min	✓	✓	✓
F max	✓	✓	✓
Phase rotation	✓	✓	–
Shedding/ reconnection	Off	On	–
Current I	✓	✓	–
Power P	✓	✓	–

- The resettable alarms linked to device tripping are activated when the I_r , I_{sd}/I_i or I_{\leq} thresholds are overrun.

- The Ir alarm is reset one second after tripping. The Isd/li and  alarms are reset by pressing the  button.
- Delayed alarms are activated when the pickup and dropout thresholds are overrun and the corresponding time delays have expired.

Identical pickup and dropout thresholds

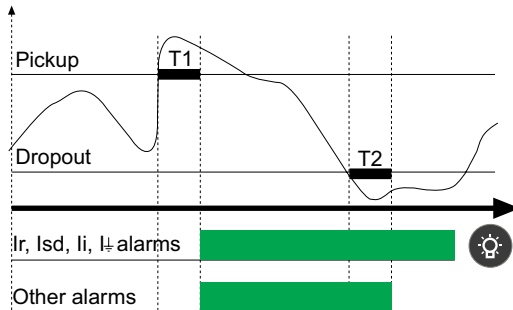

Different pickup and dropout thresholds

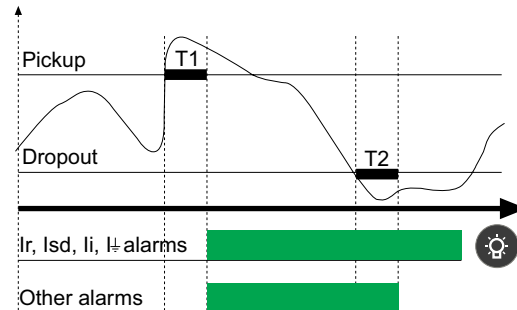

- History logging
 - Alarm mode: as soon as a given protection threshold is overrun, an alarm is recorded in the **Alarm history**
 - Trip mode: as soon as a given protection threshold is overrun, the circuit breaker trips and the fault is recorded in the **Trip history**.
- The **Protection setup** menu under **History, maintenance and setup** is used to enable or disable the Trip mode that is displayed in the protection-setting screens. On leaving the factory, the protection functions are set to Alarm mode.

Event Histories

Trip History

Trip	
22/11/1999	
02:04:04	
Umin	160V

- The trip history is the means to display at any time the parameters measured during the last ten trips.
- For each trip, the following parameters are recorded:
 - Tripping cause
 - Trip threshold
 - Interrupted currents in amperes (only if an external power supply is present) for I_r , $I_{sd/li}$, I_g or $I_{\Delta n}$ trips
 - Date
 - Time (hours, minutes and seconds)

NOTE: The interrupted currents are indicated in terms of their peak values.

Alarm History

Alarm	
27/01/1999	
13:06:09	
I2 max	3400A

- The alarm history is the means to display at any time the parameters measured during the last ten alarms.
- For each alarm, the following parameters are recorded:
 - Alarm cause
 - Alarm threshold
 - Date
 - Time (hours, minutes and seconds)

Operation Counter and Contact Wear Indicator

Operation Counter

This function is available only via the COM communications option.

MicroLogic P trip unit:

- Stores and displays the total number of operations (incremented each time the circuit breaker opens) since the initial installation of the circuit breaker.
- Stores and displays the total number of operations since the last reset.

Contact Wear Indication

This function can be used to:

- Determine the condition of the most worn contact in the circuit breaker. A counter is displayed on the screen. The contacts must be inspected each time the counter reaches a hundred mark. The message **Not available or circuit breaker type not defined** is displayed if the type of circuit breaker has not been defined. In this case, see **Breaker selection** in the **MicroLogic setup** menu under **History, maintenance and setup**.
- Reset the indicator after changing the main contacts. Reset is also carried out via **Breaker selection** in the **MicroLogic setup** menu.

NOTE: If the trip unit is changed, the circuit breaker must be defined again. In this case, see **Breaker selection** in the **MicroLogic setup** menu under **History, maintenance and setup**.

Communication Function

Modbus Communication Option

The Modbus communication option enables a ComPacT NS circuit breaker to be connected to a supervisor or to any other device with a master Modbus communication channel.

The Modbus communication option consists of the BCM ULP circuit breaker communication module, installed behind the MicroLogic trip unit.

With the communication option, the ComPacT NS circuit breaker can be connected to the following networks:

- An RS-485 serial line network with Modbus protocol via an IFM Modbus-SL interface for one circuit breaker
- An Ethernet network with Modbus TCP/IP protocol via an IFE Ethernet interface for one circuit breaker or an IFE Ethernet switchboard server

For more information, refer to DOCA0220EN *ComPacT NS - Modbus Communication Guide*.

Communication Architecture

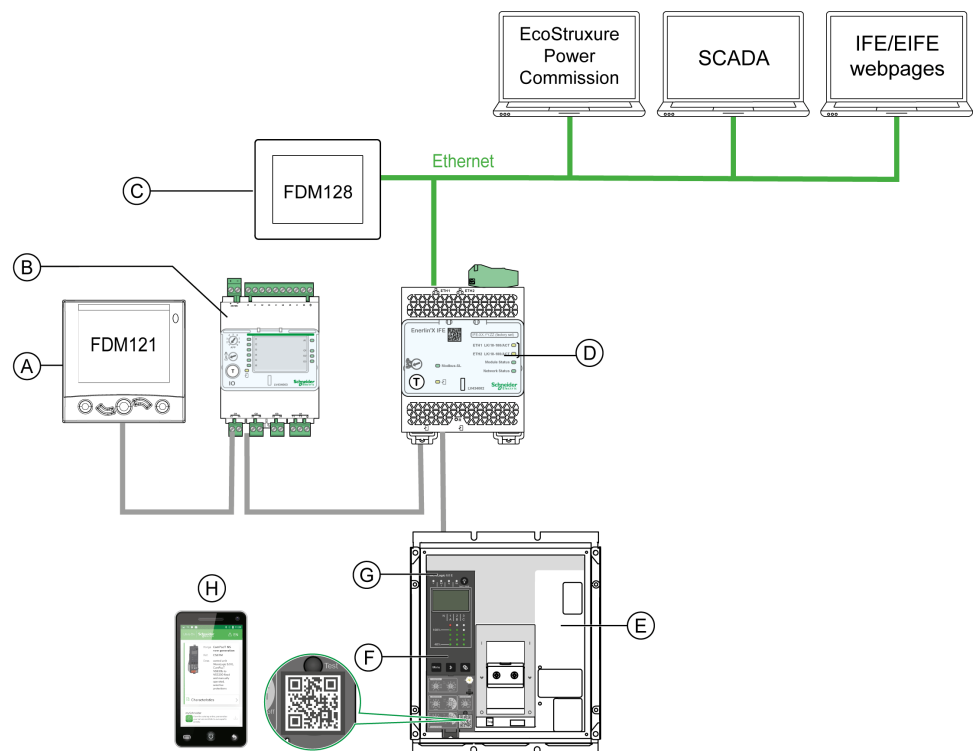

- FDM121 front display module for one circuit breaker
- IO input/output application
- FDM128 Ethernet display for eight devices
- IFE interface
- ComPacT NS circuit breaker
- MicroLogic trip unit
- BCM ULP circuit breaker communication module (installed in ComPacT NS circuit breaker)
- Go2SE landing page

Maintenance of MicroLogic Trip Unit

What's in This Part

Viewing the Event Histories.....	92
Viewing the Operation Counter and Contact Wear Indicator.....	93
Checking and Replacing the Battery.....	94
Testing the Ground-Fault and Earth-Leakage Functions.....	96
Testing the MicroLogic P Trip Unit.....	97

Viewing the Event Histories

Trip History



Select the command  **Event history > Trip history.**

Trip
history

U min	27/01/1999
-------	------------

Ir
27/06/1998

Ir
18/02/1998

  then 

Select a trip.

Trip

22/11/1999
02:04:04
Umin 160V

View.

Alarm History



Select the command  **Event history > Alarm history.**

Alarm
history

I2 max	27/01/1999
--------	------------

In max
23/03/1998

U max
12/02/1998

  then 

Select an alarm.

Alarm

27/01/1999
13:06:09
I2 max 3400A

View.

Viewing the Operation Counter and Contact Wear Indicator

Viewing and/or Resetting the Operation Counter

Select the command  **Event history > Operation counter**

Number of operations

Total
17824

Operations since last reset
6923

Reset (- / +)

Number of operations

Total
17824

Operations since last reset
0

Reset (- / +)



 Reset...

Number of operations

Total
17824

Operations since last reset
6923

Reset (- / +)

 then 
... or cancel the reset, then confirm.

Checking the Contact Wear

Select the command  **Event history > Contact wear**

Contact wear

59



NOTE: Contact wear is indicated from 0 to 900. The contacts should be inspected every time the counter reaches a multiple of 100.

Checking and Replacing the Battery

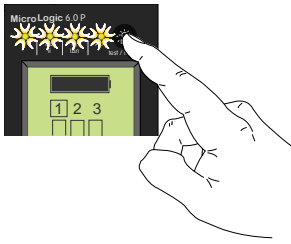
Checking the Internal Battery



Press and hold down the test button on the trip unit to check the LEDs and the battery. The battery information is displayed if the trip unit is equipped with an external power supply or if the circuit breaker is ON.

	Battery charged
	Battery half charged
	Change battery

Internal Battery

If the MicroLogic P battery needs to be changed, order a new battery in its housing cover with the Schneider Electric catalogue number **33593**.

- Lithium battery
- 1/2 AA, 3.6 V, 900 mA/h
- Ambient temperature: -55 °C to 130 °C (-67 °F to 266 °F)

Replacing the Internal Battery

DANGER

HAZARD OF ELECTRIC SHOCK, EXPLOSION, OR ARC FLASH

- Apply appropriate personal protective equipment (PPE) and follow safe electrical work practices. See NFPA 70E, CSA Z462, NOM 029-STPS or local equivalent.
- This equipment must only be installed and serviced by qualified electrical personnel.
- Turn off all power supplying this equipment before working on or inside this equipment.
- Always use a properly rated voltage sensing device to confirm power is off.
- Put back all devices, doors, and covers before turning on power to this equipment.
- Beware of potential hazards, and carefully inspect the work area for tools and objects that may have been left inside the equipment.

Failure to follow these instructions will result in death or serious injury.

Follow this procedure to replace the internal battery:

1. Remove the circuit breaker front cover as directed in the circuit breaker instruction sheet.
2. Remove the battery and its housing cover: insert a small screwdriver blade into battery housing cover notch and rotate to slide battery housing cover out of trip unit.

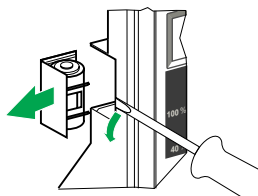

- Put the new battery and its housing cover back in place.

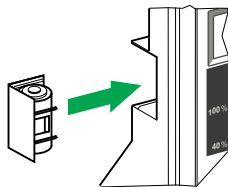

- Press  to check the new battery.
- Reinstall the circuit breaker front cover as directed in the circuit breaker instruction sheet.

DANGER

HAZARD OF ELECTRIC SHOCK, EXPLOSION, OR ARC FLASH

- Put back circuit breaker front cover before energizing circuit breaker to help prevent access to live terminals.
- Do not pinch the wires when reinstalling the front cover.

Failure to follow these instructions will result in death or serious injury.

Testing the Ground-Fault and Earth-Leakage Functions

Proceed as follows to test:

- Ground-fault protection on MicroLogic 6.0 P trip unit
 - Earth-leakage protection on MicroLogic 7.0 P trip unit
1. Check that the circuit breaker is closed.
 2. Use a thin screwdriver to briefly push in (< 1 s) the TEST button on the front face of the MicroLogic trip unit.

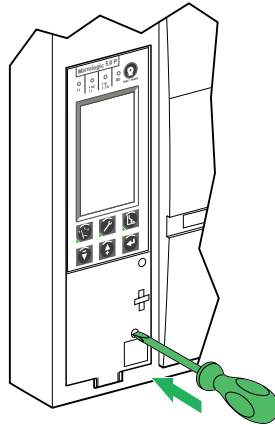

3. The circuit breaker trips.
4. If the circuit breaker does not trip, contact your field service representative.

Testing the MicroLogic P Trip Unit

Test the trip unit using EcoStruxure Power Commission software installed on a PC and connected to the MicroLogic trip unit through the Service Interface.

Testing Architecture

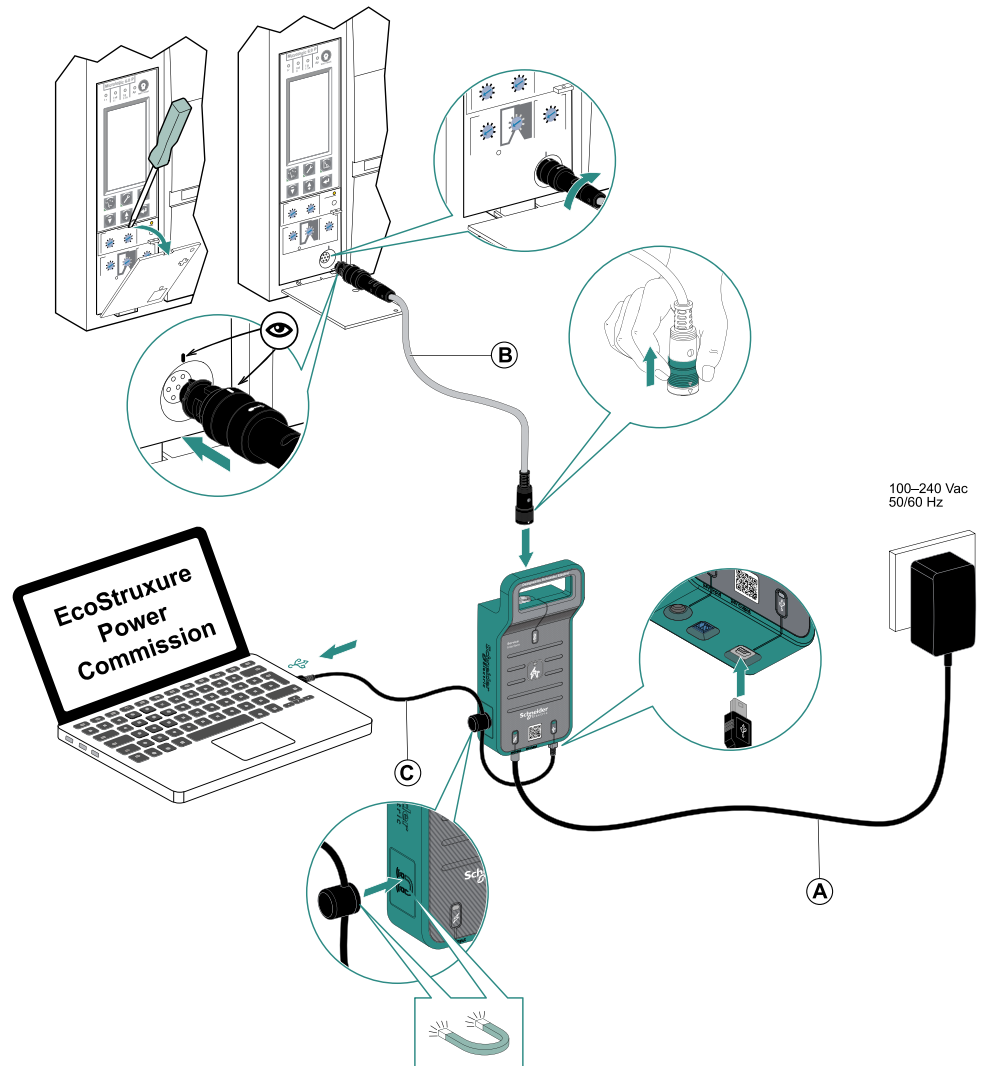

- A. AC/DC power supply
- B. 7-pin cable for ComPacT NS trip units
- C. USB cable with magnet

For more information, refer to [GDE78167 Service Interface - Instruction Sheet](#).

Test Functions with EcoStruxure Power Commission Software

EcoStruxure Power Commission software allows you to perform the following actions on a communicating MicroLogic trip unit through the Service Interface:

- Automatic trip curve tests
- Device check up (Force trip test)
- Zone-selective interlocking (ZSI) test
- Preparation for primary injection tests

For more information, refer to [DOCA0170EN Service Interface - User Guide](#).

Technical Appendix

What's in This Part

Tripping Curves.....	99
Voltage Measurements	101
Long-Time Rating Plug	104
Zone Selective Interlocking (ZSI).....	107
Power Supply	110
Thermal Memory	113
Threshold and Time-Delay Settings	114
Other Settings	117
Measurement Ranges and Accuracy	119
Power Factor Sign Conventions	121

Tripping Curves

I²t Long-Time, Short-Time and Instantaneous Protection - MicroLogic 5.0 P, 6.0 P, 7.0 P Trip Units

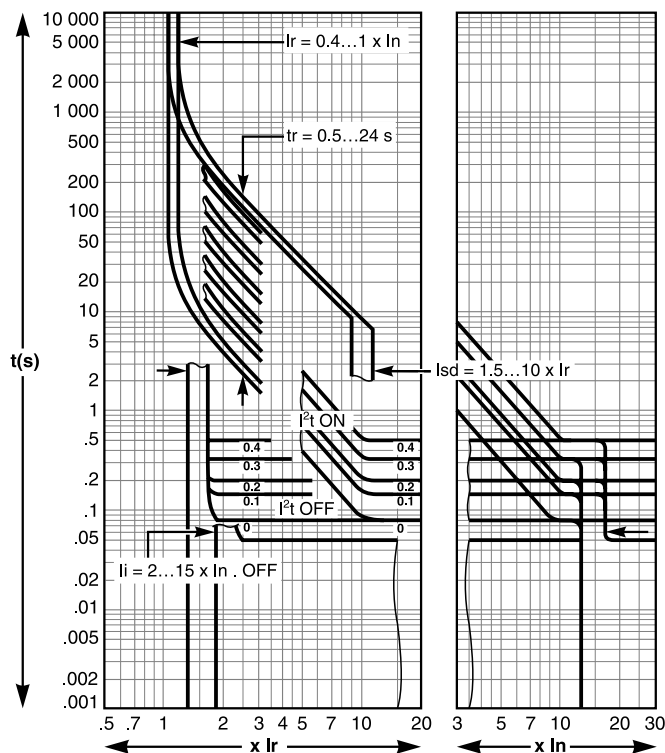

I_{dmtl} Long-Time, Short-Time and Instantaneous Protection - MicroLogic 5.0 P, 6.0 P, 7.0 P Trip Units

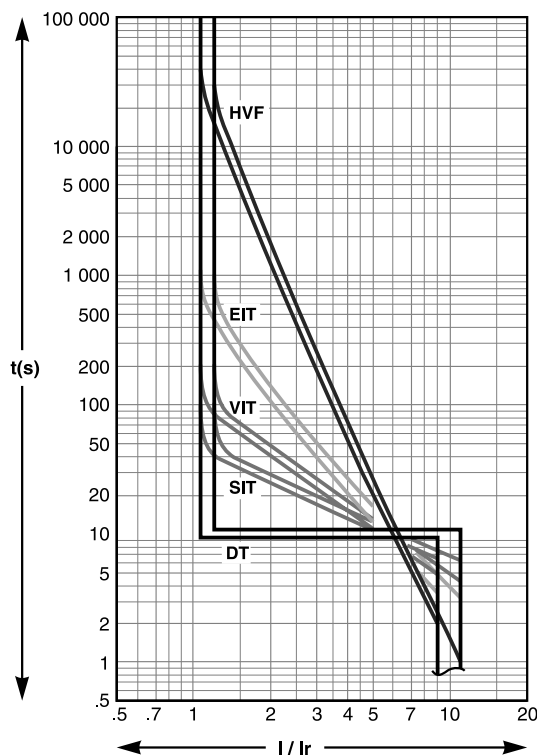

Ground-Fault Protection - MicroLogic 6.0 P Trip Unit

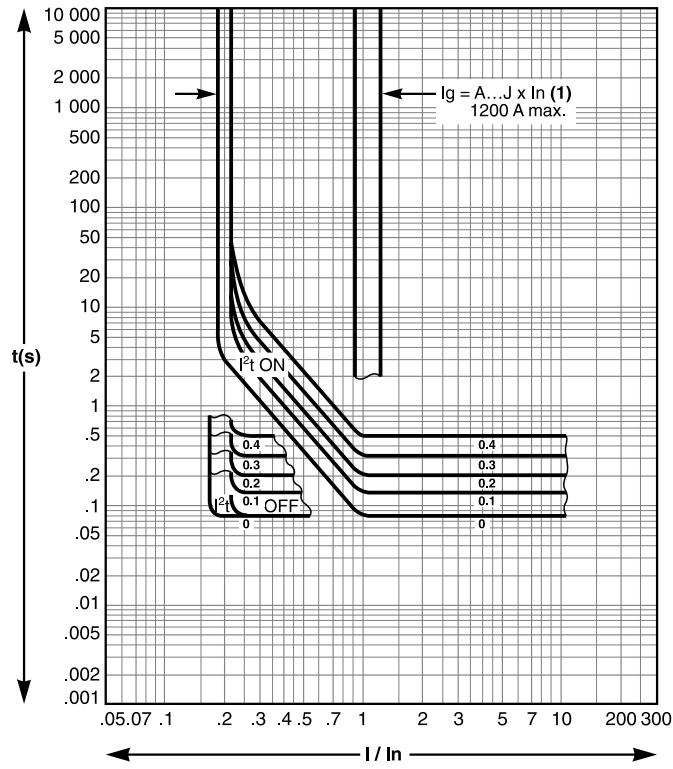

Voltage Measurements

The MicroLogic P trip unit is equipped with a three-phase voltage power supply that, with respect to the distribution system, may be considered a delta load. The three-phase power supply reinjects voltage on an open phase. The voltage-protection functions react as indicated below.

Minimum-Voltage Protection

This function is based on the measurement of the phase-to-phase voltages.

In diagrams 1, 3 and 4 on the next page, a fuse has blown. The trip unit reinjects voltage on the failed phase and measures a phase-to-phase voltage higher than the actual voltage. The phase-to-neutral voltage should be zero, but the value measured is not zero.

In diagram 2, the phase-to-neutral voltage is effectively zero and the measurement indicates zero as well.

By limiting the pickup threshold of the minimum-voltage protection to the 80% - 100% range of the rated distribution-system voltage, the differences between the real voltages and the measured values are not significant and the MicroLogic trip unit will operate under all circumstances in the expected manner.

Voltage-Unbalance Protection

This function is based on the measurement of the phase-to-phase voltages.

In diagrams 1, 3 and 4 on the next page, a fuse has blown. The trip unit reinjects voltage on the failed phase and measures a phase-to-phase voltage higher than the actual voltage. The phase-to-neutral voltage should be zero, but the value measured is not zero.

In diagram 2, the phase-to-neutral voltage is effectively zero and the measurement indicates zero as well.

By limiting the pickup threshold of the voltage-unbalance protection to the 0% - 20% range, the differences between the real voltages and the measured values are not significant and the MicroLogic trip unit will operate under all circumstances in the expected manner.

Phase Failure

Detection of phase failure is not possible on the basis of the minimum-voltage and voltage-unbalance protection functions. The MicroLogic power supply requires at least two phases (between 100 and 690 V).

In diagrams 1, 3 and 4, if two phases have failed, the MicroLogic P trip unit measures for the three phases the value of the single voltage present (e.g. $U_{12} = U_{23} = U_{31} = 410 \text{ V}$).

Diagram 1

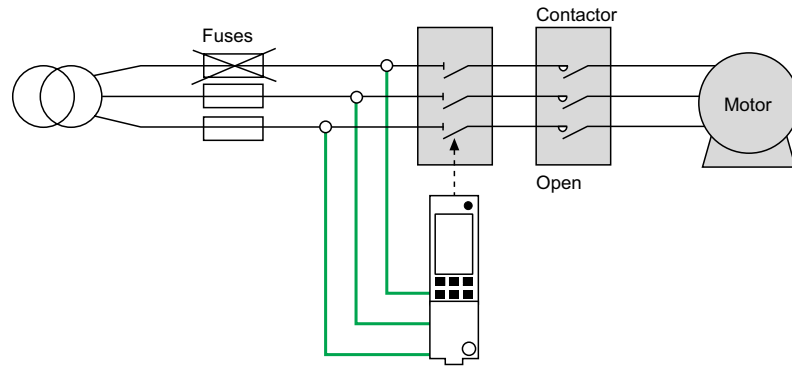

Diagram 2

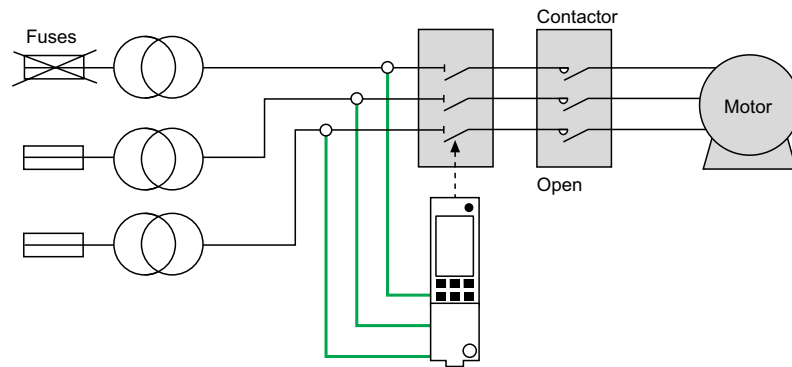

Diagram 3

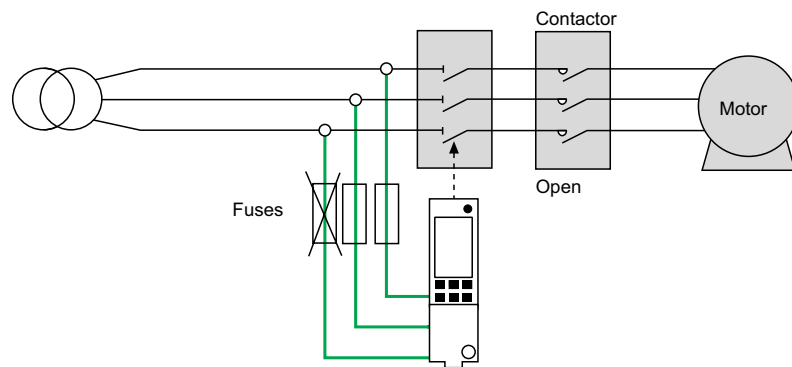
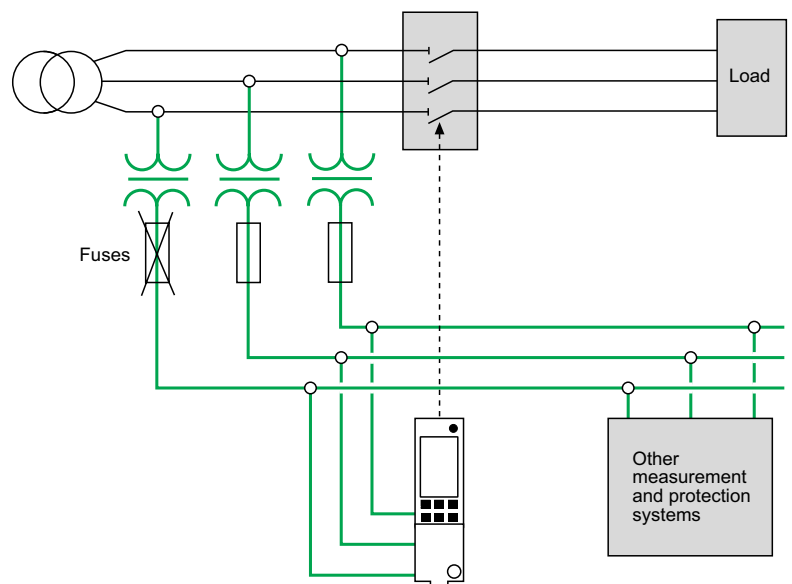

Diagram 4



Selection of the Voltage Measurement Inputs

The voltage measurement inputs are standard equipment on the downstream connectors of the circuit breaker.

It is possible to measure distribution-system voltage externally using the PTE external voltage measurement input option.

With this option, the internal voltage measurement inputs are disconnected. The PTE option is required for voltages greater than 690 V (in which case a voltage transformer is required).

When the PTE option is implemented, the supply circuit of the voltage measurement input must be protected against short-circuits. Installed as close as possible to the busbars, this protection function is ensured by a P25M circuit breaker (1 A rating) with an auxiliary contact (cat. no. 21104 and 21117).

The supply circuit of the voltage measurement input is reserved exclusively for the trip unit and must never be used to supply other circuits.

Long-Time Rating Plug

One of the four interchangeable long-time rating plugs can be used to limit the long-time pickup setting range for higher accuracy of the long-time overcurrent protection, page 50.

Selecting the Long-Time Rating Plug

The available rating plugs are listed in the following table:

Part number	Setting range for the I_r value	
C33542	Standard	0.4 to 1 x I_r
C33543	Low setting	0.4 to 0.8 x I_r
C33544	High setting	0.8 to 1 x I_r
C33545	Without long-time protection $I_r = I_n$ for short-time protection setting	

NOTE: If no long-time rating plug is installed, the trip unit continues to operate under the following downgraded conditions:

- The long-time current setting I_r is 0.4.
- The long-time time delay t_r corresponds to the value indicated by the adjustment dial.
- The earth-leakage protection function is disabled.
- The voltage-measurement inputs are disconnected.

Replacement Procedure

DANGER

HAZARD OF ELECTRIC SHOCK, EXPLOSION, OR ARC FLASH

- Apply appropriate personal protective equipment (PPE) and follow safe electrical work practices. See NFPA 70E, CSA Z462, NOM 029-STPS or local equivalent.
- This equipment must only be installed and serviced by qualified electrical personnel.
- Turn off all power supplying this equipment before working on or inside this equipment.
- Always use a properly rated voltage sensing device to confirm power is off.
- Put back all devices, doors, and covers before turning on power to this equipment.
- Beware of potential hazards, and carefully inspect the work area for tools and objects that may have been left inside the equipment.

Failure to follow these instructions will result in death or serious injury.

NOTICE

HAZARD OF TRIP UNIT DETERIORATION

Prior to running dielectric strength tests, it is mandatory to:

- Remove the long-time rating plug on MicroLogic P trip unit.
- Disconnect all electrical auxiliaries (for example, MX or MN voltage releases) connected to the device.

Failure to follow these instructions can result in equipment damage.

Follow this procedure to change or remove the rating plug:

NOTE: Following any modifications to the long-time rating plug, all trip-unit protection parameters must be checked.

1. Open the circuit breaker.
2. Open the protective cover of the trip unit.

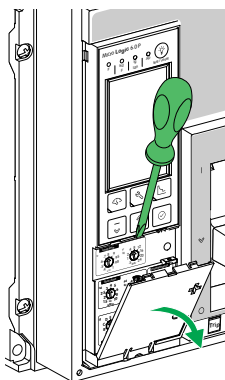

3. Record switch settings.
4. Unscrew the long-time rating plug mounting screw.

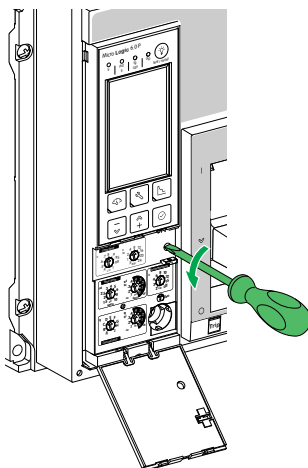

5. Remove the adjustable rating plug.

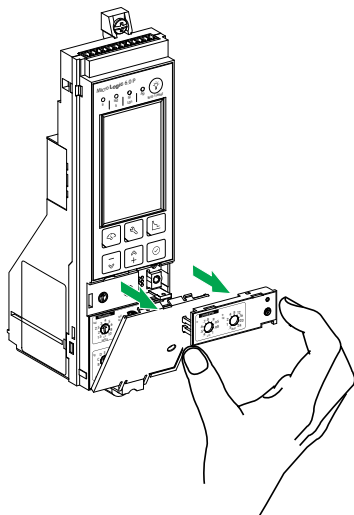

6. Inspect mounting area for debris and contamination.
7. Take out the replacement rating plug.
8. Gently push in the replacement rating plug.

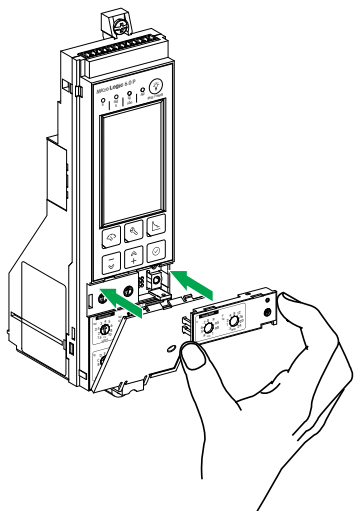

9. Tighten the long-time rating plug mounting screw.

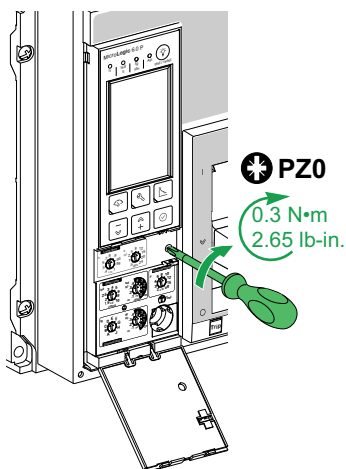

10. Set trip unit settings to values recorded previously or modify settings.

Zone Selective Interlocking (ZSI)

Presentation

Zone-selective interlocking (ZSI), also called zone restraint, is a system designed to reduce the stress on electrical distribution equipment during short-circuit or ground-fault conditions.

ZSI works with a previously coordinated distribution system to limit stress on the system by reducing the time it takes to clear the electrical fault while maintaining system coordination between overcurrent and ground-fault protective devices.

ZSI allows MicroLogic trip units to communicate with each other so that a short-circuit or ground-fault can be isolated and cleared by the nearest upstream circuit breaker with no intentional time delay. Devices in all other areas of the system (including upstream) remain closed to maintain service to unaffected loads.

Without ZSI, a coordinated system results in the circuit breaker closest to the electrical fault clearing it, usually with an intentional delay. With ZSI, the device closest to the electrical fault ignores its preset short-time and ground-fault delays and clears the electrical fault with no intentional delay.

Zone-selective interlocking eliminates intentional delay without sacrificing coordination and it results in faster tripping times. This limits stress on the system by reducing the amount of let-through energy the system is subjected to during an overcurrent.

The coordination of the system must be correctly set up for zone-selective interlocking to work.

Operating Principle

A pilot wire interconnects a number of circuit breakers equipped with MicroLogic trip units, as illustrated in the following diagram.

The trip unit detecting an electrical fault sends a signal upstream and checks for a signal arriving from downstream. If there is a signal from downstream, the circuit breaker remains closed for the full duration of its time delay. If there is no signal from downstream, the circuit breaker opens immediately, regardless of the time delay setting.

- An electrical fault occurs at point A.

Downstream device (2) clears the electrical fault and sends a signal to upstream device (1), which maintains the short-time time delay t_{sd} or the ground-fault time delay t_g to which it is set.

- An electrical fault occurs at point B.

Upstream device (1) detects the electrical fault. In the absence of a signal from a downstream device, the set time delay is not taken into account and the device trips according to the zero setting. If it is connected to a device further upstream, it sends a signal to that device, which delays tripping according to its t_{sd} or t_g setting.

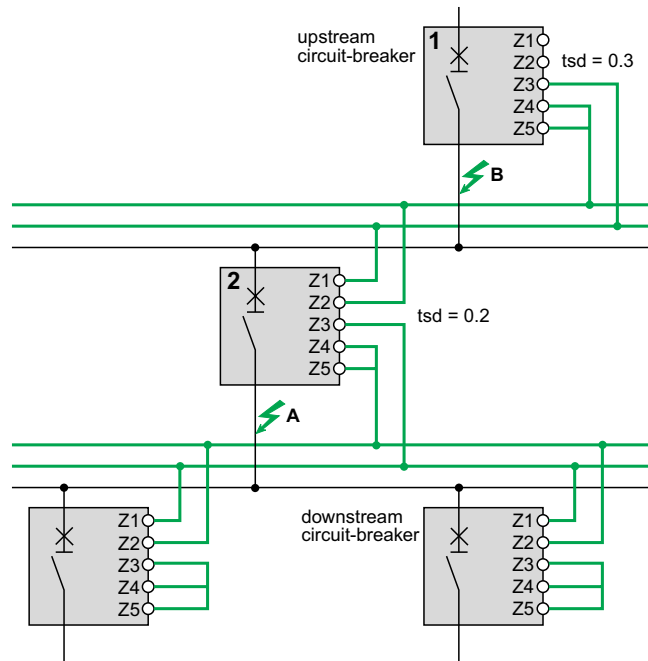

NOTE: On device (1), the tsd and tg time delays must not be set to zero because this would make selectivity impossible.

Connections Between Trip Units

A logic signal (0 or 5 V) can be used for zone selective interlocking between the upstream and downstream circuit breakers equipped with:

- MicroLogic 5.0 A, 6.0 A, 7.0 A.
- MicroLogic 5.0 E, 6.0 E.
- MicroLogic 5.0 P, 6.0 P, 7.0 P.
- MicroLogic 5.0 H, 6.0 H, 7.0 H.

An interface is available for connection to previous generations of trip units.

Wiring

Technical characteristics of wires:

- Maximum impedance: 2.7 Ω / 300 m (1 000 ft)
- Capacity of connectors: 0.4 to 2.5 mm² (AWG 22 to 14)
- Wires: single or multicore
- Maximum length: 3000 m (10 000 ft)
- Limits to device interconnection:
 - The common ZSI - OUT (Z1) and the output ZSI - OUT (Z2) can be connected to a maximum of 10 upstream devices.
 - Maximum of 100 downstream devices may be connected to the common ZSI - IN (Z3) and to an input ZSI - IN CR (Z4) or GF (Z5).

NOTE: Terminals Z1 to Z5 correspond to the identical indications on the circuit-breaker terminal blocks.

NOTE: If the protection function is not used on circuit breakers equipped for ZSI protection, a jumper must be installed to short terminals Z3, Z4 and Z5. If the jumper is not installed, the short-time and ground-fault time delays are set to zero, whatever the position of the adjustment dial.

Test

Check the wiring and operation of zone selective interlocking between a number of circuit breakers by using EcoStruxure Power Commission software installed on a PC and connected to the MicroLogic trip unit through the Service Interface.

For more information, refer to [Testing the MicroLogic Trip Unit](#), page 97.

Power Supply

Internal and External Power Supplies

The MicroLogic trip unit is powered by the current through the internal current transformers (CT).

- The standard protection functions of MicroLogic trip units operate with the internal current supply.
- If the load current is higher than 20% of the rated current I_n , the internal current supply provides the power supply for the full functioning of the MicroLogic trip unit. This includes:
 - The MicroLogic HMI, display screen and LEDs
 - The metering functions

To provide a power supply to the MicroLogic trip unit when the load is below 20% of the rated current I_n , and maintain the full functioning of the MicroLogic trip unit, a permanent external 24 Vdc power supply can be used.

External 24 Vdc Power Supply

The 24 Vdc power supply maintains the operation of all functions of the MicroLogic trip unit in all circumstances, even when the circuit breaker is open and not energized.

The 24 Vdc power supply maintains the functions of the MicroLogic trip unit in low load conditions (load below 20%).

NOTICE

LOSS OF DOUBLE INSULATION

- Supply the MicroLogic trip unit with a 24 Vdc SELV (Safety Extra Low Voltage) power supply only, connected to the F1-/F2+ terminals. Pay attention to the polarity.
- Do not connect devices which have double insulation to the 24 Vdc SELV power supply which is being used to supply the MicroLogic trip unit. For example, do not use the same 24 Vdc SELV power supply to supply a MicroLogic trip unit for ComPacT NS circuit breakers and a MicroLogic X control unit for MasterPact MTZ circuit breakers.

Failure to follow these instructions will result in a basic/single insulated system.

NOTICE

HAZARD OF EQUIPMENT DAMAGE

- Do not use the same 24 Vdc SELV power supply to supply the MicroLogic trip unit and the other ULP modules connected to the BCM ULP module.
- Do not use the same 24 Vdc SELV power supply to supply more than one MicroLogic trip unit.

Failure to follow these instructions can result in equipment damage.

Recommendations for use of external 24 Vdc SELV power supplies:

- Use separate 24 Vdc power supplies to supply each MicroLogic trip unit. You can use the same 24 Vdc power supply to supply the ULP modules in several Intelligent Modular Units (IMU).
- Use a separate 24 Vdc power supply to supply the MN or MX voltage releases.

Recommended 24 Vdc Power Supply

The following 24 Vdc power supply is recommended for use with ComPacT NS devices. For more information, refer to the *ComPacT NS Catalogue*.

Characteristic	AD power supply
Illustration	
Overvoltage category defined by IEC 60947-1	<ul style="list-style-type: none"> • Category IV per IEC 62477-1 (Vac model) • Category III per IEC 62477-1 (Vdc model) • Category III per UL 61010-1
Input supply voltage AC	<ul style="list-style-type: none"> • 110–130 Vac • 200–240 Vac
Input supply voltage DC	<ul style="list-style-type: none"> • 24–30 Vdc • 48–60 Vdc • 100–125 Vdc
Dielectric withstand	Input/output: <ul style="list-style-type: none"> • 3 kV RMS for 1 minute (110–130 Vac and 200–240 Vac model) • 3 kV RMS for 1 minute (110–125 Vdc model) • 2 kV RMS for 1 minute (24–30 Vdc and 48–60 Vdc model)
Temperature	70 °C (158 °F)
Output current	1 A
Ripple	200 mV peak-peak
Output voltage setting for line loss compensation	22.8–25.2 Vdc

24 Vdc Backup Battery

If the 24 Vdc power supply is interrupted, a 24 Vdc backup battery can be used to maintain the operation of the MicroLogic trip unit. It is installed in series between the MicroLogic trip unit and the 24 Vdc power supply module.

The 24 Vdc backup battery must have the following characteristics (compatible with the MicroLogic trip unit):

- Output voltage 17–28.8 Vdc
 - Cut-off voltage 17 Vdc (24 Vdc backup battery must have a shutdown output voltage in case of low voltage level)
 - Hysteresis > 3 Vdc (to avoid power-on before the voltage is up to 21 Vdc)
- 24 Vdc backup battery should be able to power an Inrush current of 10 A

Internal Battery

When no other power supply is supplying the MicroLogic trip unit, the internal battery powers the trip cause LEDs.

ULP Module Consumption

The same power supply can be used to supply the ULP modules of several intelligent modular units (IMU).

The following table lists the ULP module consumption:

Module	Typical consumption (24 Vdc at 20 °C/68 °F)	Maximum consumption (19.2 Vdc at 60 °C/140 °F)
BCM ULP circuit breaker communication module for MasterPact NT/NW and ComPact NS circuit breakers	40 mA	300 mA
IFE Ethernet interface for one circuit breaker	100 mA	140 mA
IFE Ethernet switchboard server	100 mA	140 mA
IFM Modbus-SL interface or one circuit breaker	21 mA	30 mA
FDM121 front display module for one circuit breaker	21 mA	30 mA

Thermal Memory

Presentation

The thermal memory is the means to take into account temperature rise and cooling caused by changes in the flow of current in the conductors.

These changes may be caused by:

- Repetitive motor starting
- Loads fluctuating near the long-time protection settings
- Repeated circuit-breaker closing on a fault.

Trip units without a thermal memory (contrary to bimetal strip thermal protection) do not react to the above types of overloads because they do not last long enough to cause tripping. However, each overload produces a temperature rise and the cumulative effect can lead to dangerous overheating.

Trip units with a thermal memory record the temperature rise caused by each overload, even those that are very short. This information stored in the thermal memory reduces the tripping time.

MicroLogic Trip Units and Thermal Memory

All MicroLogic trip units are equipped as standard with a thermal memory.

For all protection functions, prior to tripping, the temperature-rise and cooling time constants are equal and depend on the t_r time delay:

- If the time delay is short, the time constant is low.
- If the time delay is long, the time constant is high.

For long-time protection, following tripping, the cooling curve is simulated by the trip unit. Closing of the circuit breaker prior to the end of the time constant (approximately 15 minutes) reduces the tripping time indicated in the tripping curves.

Short-Time Protection and Intermittent Faults

For the short-time protection function, intermittent currents that do not provoke tripping are stored in the MicroLogic memory.

This information is equivalent to the long-time thermal memory and reduces the time delay for the short-time protection.

Following a trip, the short-time t_{sd} time delay is reduced to the value of the minimum setting for 20 seconds.

Ground-Fault Protection and Intermittent Faults

The ground-fault protection implements the same intermittent fault function as the short-time protection.

Threshold and Time-Delay Settings

Current Protection Functions

Function	Setting	Range	Factory setting	Step	Accuracy
Long-time protection	I _r current setting	0.4 to I _n	Maximum	1 A	1.05 to 1.20 I _r
	t _r time delay	0.5 to 24 s	Maximum	0.5 s	- 20%, + 0%
Short-time protection	I _{sd} pickup	1.5 to 10 I _r	Maximum	10 A	± 10%
	t _{sd} time delay	0 - 0.1 - 0.2 - 0.3 - 0.4 s	Maximum	0.1 s	–
Instantaneous protection	I _{li} pickup	2 to 15 I _n in ERMS mode	Maximum	10 A	± 10%
Ground-fault protection	I _g pickup	Depends on rating	Maximum	1 A	± 10%
	t _g time delay	0 - 0.1 - 0.2 - 0.3 - 0.4 s	Maximum	0.1 s	–
Earth-leakage protection	I _{Δn} pickup	–	Maximum	0.1 A	- 20%, + 0%
	Δt time delay	60 - 140 - 230 - 350 - 800 ms	Maximum	1 setting	–
Neutral protection	Three-pole device	Off, N/2, N, 1.6xN	Off	–	–
	Four-pole device	Off, N/2, N	N/2	–	–

Additional Current Protection Functions

Function	Setting	Range	Factory setting	Step	Accuracy
Current unbalance	Pickup threshold	5% to 60%	60%	1%	-10%, +0%
	Dropout threshold	5% of pickup threshold	Pickup threshold	1%	-10%, +0%
	Pickup time delay	1 s to 40 s	40 s	1 s	-20%, +0%
	Dropout time delay	10 s to 360 s	10 s	1 s	-20%, +0%
Ground-fault alarm	Pickup threshold	20 A to 1200 A	120 A	1 A	+/- 15%
	Dropout threshold	20 A to pickup threshold	Pickup threshold	1 A	+/- 15%
	Pickup time delay	1 s to 10 s	10 s	0.1 s	-20%, +0%
	Dropout time delay	1 s to 10 s	1 s	0.1 s	-20%, +0%
Earth-leakage alarm	Pickup threshold	0.5 A to 30 A	30 A	0.1 A	-20%, +0%
	Dropout threshold	0.5 A to pickup threshold	Pickup threshold	0.1 A	-20%, +0%
	Pickup time delay	1 s to 10 s	10 s	0.1 s	-20%, +0%
	Dropout time delay	1 s to 10 s	1 s	0.1 s	-20%, +0%
Maximum current	Pickup threshold	0.2 I _n to I _n	I _n	1 A	± 6.6%
	Dropout threshold	0.2 I _n to pickup threshold	Pickup threshold	1 A	± 6.6%
	Pickup time delay	15 s to 1500 s	1500 s	1 s	-20%, +0%
	Dropout time delay	15 s to 3000 s	15 s	1 s	-20%, +0%

Voltage Protection Functions

Function	Setting	Range	Factory setting	Step	Accuracy
Minimum voltage	Pickup threshold	100 V to U max pickup threshold	100 V	5 V	-5%, +0%
	Dropout threshold	Pickup threshold to U max Pickup threshold	Pickup threshold	5 V	-5%, +0%
	Pickup time delay	1.2 s to 5 s	5 s	0.1 s	-0%, +20%
	Dropout time delay	1.2 s to 36 s	1.2 s	0.1 s	-0%, +20%
Maximum voltage	Pickup threshold	U min pickup threshold to 1200 V	725 V	5 V	-0%, +5%
	Dropout threshold	100 V to pickup threshold	Pickup threshold	5 V	-0%, +5%
	Pickup time delay	1.2 s to 5 s	5 s	0.1 s	-0%, +20%
	Dropout time delay	1.2 s to 36 s	1.2 s	0.1 s	-0%, +20%
Voltage unbalance	Pickup threshold	2% to 30 %	30%	1%	-20%, +0%
	Dropout threshold	2% to pickup threshold	Pickup threshold	1%	-20%, +0%
	Pickup time delay	1 s to 40 s	40 s	1 s	-20%, +0%
	Dropout time delay	10 s to 360 s	10 s	1 s	-20%, +0%

Other Protection Functions

Function	Setting	Range	Factory setting	Step	Accuracy
Reverse power	Pickup threshold	5 to 500 kW	500 kW	5 kW	± 2.5%
	Dropout threshold	5 kW to pickup threshold	Pickup threshold	5 kW	± 2.5%
	Pickup time delay	0.2 s to 20 s	20 s	0.1 s	0%, +20% ³
	Dropout time delay	1 s to 360 s	1 s	0.1 s	0%, +20%
Minimum and maximum frequency	Pickup threshold	F min pickup threshold to 440 Hz	65 Hz	0.5 Hz	± 0.5 Hz
	Dropout threshold	45 Hz to pickup threshold	Pickup threshold	0.5 Hz	± 0.5 Hz
	Pickup time delay	1.2 s to 5 s	5 s	0.1 s	0%, +20% ⁴
	Dropout time delay	1.2 s to 36 s	1.2 s	0.1 s	0%, +20% ⁴
Phase rotation	Pickup threshold	Ph1, Ph2, Ph3 or Ph1, Ph3, Ph2	Ph1, Ph2, Ph3	None	None
	Dropout threshold	Pickup threshold	Pickup threshold	None	None
	Pickup time delay	0.3 s	0.3 s	None	- 0%, + 50%
	Dropout time delay	0.3 s	0.3 s	None	- 0%, + 50%

3. + 30% on dial 0.2 s

4. + 30% up to 1.5 s

Load Shedding and Reconnection

Function	Setting	Range	Factory setting	Step	Accuracy
Depending on current	Pickup threshold	50% to 100% I _r	100% I _r	1%	± 6%
	Dropout threshold	30% I _r to shedding threshold	Shedding threshold	1%	± 6%
	Pickup time delay	20% to 80% t _r	80% t _r	1%	-20%, +0%
	Dropout time delay	10 s to 600 s	10 s	1 s	-20%, +0%
Depending on power	Pickup threshold	200 kW to 10 000 kW	10 000 kW	50 kW	± 2.5%
	Dropout threshold	100 kW to shedding threshold	Shedding threshold	50 kW	± 2.5%
	Pickup time delay	10 s to 3600 s	3600 s	10 s	-20%, +0%
	Dropout time delay	10 s to 3600 s	10 s	10 s	-20%, +0%

Other Settings

MicroLogic Setup

Settings	Range	Factory setting	Step
Language	German English US English UK Italian French Spanish Chinese	English UK	–
Date / time	–	–	1 s
Circuit breaker selection	–	Not defined	–
Power sign	P+ P-	P+ (flow from top to bottom)	–
Neutral CT	–	None	–
VT ratio Primary voltage	100 to 1150 V	690 V	1 V
Secondary voltage	100 to 690 V	690 V	1 V
System frequency	50/60 Hz 400 Hz	50/60 Hz	–

Measurement Setup

Settings	Range	Factory setting	Step	
System type	3 Φ , 3 w, 3 CT 3 Φ , 4 w, 3 CT 3 Φ , 4 w, 4 CT	3 Φ , 4 w, 4 CT	–	
Demand current	Calculation method	Thermal or block interval	Block interval	–
	Window type	Fixed or sliding	Sliding	–
	Interval	5 to 60 minutes	15 minutes	1 minute
Power demand	Calculation method	Thermal or block interval or sync. to comms	Block interval	–
	Window type	Fixed or sliding	Sliding	–
	Interval	5 to 60 minutes	15 minutes	1 minute
Sign convention	IEEE IEEE alternate IEC	IEEE	–	

Communication Setup

Settings	Range	Factory setting
Com parameter	Modbus	–
Address	1-47	47
Baud rate	9600 to 19200 bauds	19200 bauds
Parity	Even None	Even
Connection	2Wires+ULP or 4Wires	2Wires+ULP
Remote settings Access permit	Yes / no	Yes
Access code	0000 to 9999	0000
Remote control	Manual Automatic	Automatic

Protection Setup

Settings	Range	Factory setting
Current protection	Alarm / trip / OFF	OFF
Voltage protection		
Other protection		

Measurement Ranges and Accuracy





The accuracy of the current measurements depends on both the value displayed (or transmitted) and the circuit-breaker rating, where:

$$\text{Accuracy} = 0.5\% I_n + 1.5\% \text{ reading}$$

Example:

For a circuit breaker with a 4000 A rating and a current displayed on MicroLogic trip unit of 49 A, the accuracy is:

$$0.5\% \times 4000 + 1.5\% \times 49 = \pm 21 \text{ A}$$

Measurement type	Measurement	Range	Accuracy at 25 °C
Instantaneous current	I1, I2, I3	0.05 x In to 20 x In	±1.5%
	IN	0.05 x In to 20 x In	±1.5%
	 ground	0.05 x In to In	±10%
	 earth leakage	0 to 30 A	±1.5%
	I1 max, I2 max, I3 max	0.05 x In to 20 x In	±1.5%
	IN max	0.05 x In to 20 x In	±1.5%
	 max ground	0.05 x In to In	±10%
	 max earth leakage	0 to 30 A	±1.5%
Demand current	$\bar{I}1, \bar{I}2, \bar{I}3$	0.05 x In to 20 x In	±1.5%
	$\bar{I}N$	0.05 x In to 20 x In	±1.5%
	$\bar{I}1 \text{ max}, \bar{I}2 \text{ max}, \bar{I}3 \text{ max}$	0.05 x In to 20 x In	±1.5%
	$\bar{I}N \text{ max}$	0.05 x In to 20 x In	±1.5%
Phase-to-phase voltages	U12	170 to 1150 V	±0.5%
	U23	170 to 1150 V	±0.5%
	U31	170 to 1150 V	±0.5%
Phase-to-neutral voltages	V1N	100 to 1150 V	±0.5%
	V2N	100 to 1150 V	±0.5%
	V3N	100 to 1150 V	±0.5%
Average voltage	U avg	170 to 1150 V	±0.5%
Voltage unbalance	U unbal	0 to 100%	±0.5%
Instantaneous power	P	0.015 to 184 MW	±2%
	Q	0.015 to 184 Mvar	±2%
	S	0.015 to 184 MVA	±2%
Power factor	PF	-1 to +1	±2%
Demand power	P	0.015 to 184 MW	±2%
	Q	0.015 to 184 Mvar	±2%
	S	0.015 to 184 MVA	±2%
	P max	0.015 to 184 MW	±2%
	Q max	0.015 to 184 Mvar	±2%
	S max	0.015 to 184 MVA	±2%
Total energy	E.P	-10 ¹⁰ GWh to +10 ¹⁰ GWh	±2%
	E.Q	-10 ¹⁰ Gvarh to +10 ¹⁰ Gvarh	±2%
	E.S	-10 ¹⁰ GVAh to +10 ¹⁰ GVAh	±2%

Total energy in	E.P	-10 ¹⁰ GWh to +10 ¹⁰ GWh	±2%
	E.Q	-10 ¹⁰ Gvarh to +10 ¹⁰ Gvarh	±2%
Total energy out	E.P	-10 ¹⁰ GWh to +10 ¹⁰ GWh	±2%
	E.Q	-10 ¹⁰ Gvarh to +10 ¹⁰ Gvarh	±2%
Frequency	F	45 Hz to 440 Hz	±0.1%

Power Factor Sign Conventions

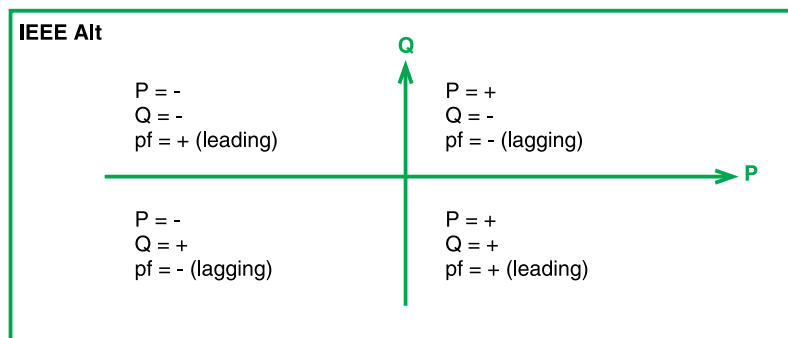
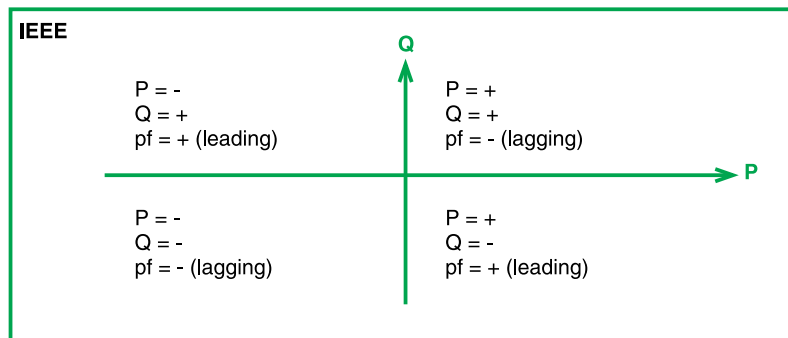
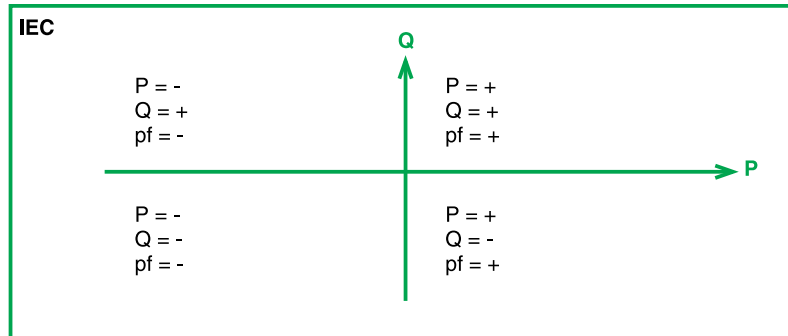
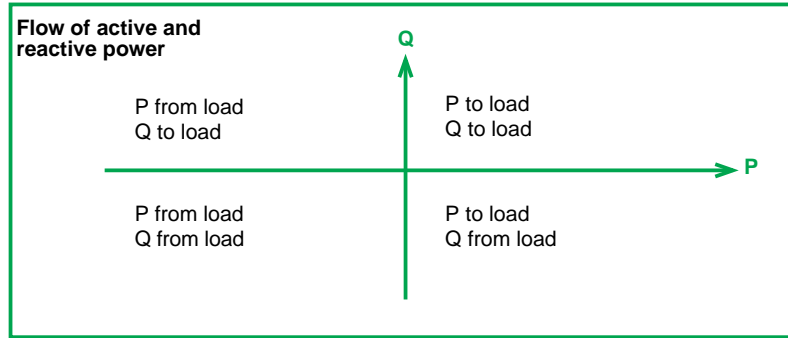

Schneider Electric
35 rue Joseph Monier
92500 Rueil Malmaison
France

+ 33 (0) 1 41 29 70 00

www.se.com

As standards, specifications, and design change from time to time,
please ask for confirmation of the information given in this publication.

© 2022 Schneider Electric. All rights reserved.

DOCA0219EN-00