

YCS

Domaine d'application : Industrie

Manchons de jonction cuivre

Description :

Cuivre électrolytique.

Etamage électrolytique

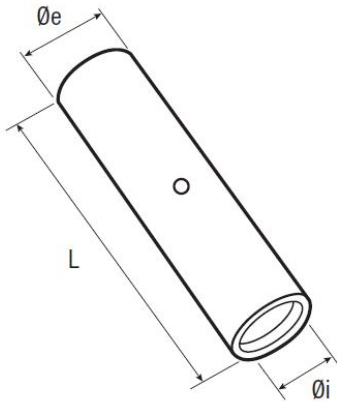

Section câble (mm ²)	Code article	Réf.	Conditionnement	Ø i	Øe	L	Matrice
95	7435301	YCS095TN	25	13,5	19	70	...K18