



# SLG10S-160FAR21A00

## SLG-2

SWITCHING AUTOMATION LIGHT GRIDS

**SICK**  
Sensor Intelligence.



### Ordering information

Type	Part no.
SLG10S-160FAR21A00	1124878

Other models and accessories → [www.sick.com/SLG-2](http://www.sick.com/SLG-2)

Illustration may differ



### Detailed technical data

#### Features

<b>Included with delivery</b>	1 × sender 1 × receiver 1 × Quick Start Guide 1 x safety instruction
<b>Functional principle</b>	Sender/receiver
<b>Sensing range</b>	
Limit values	440 mm ... 4,900 mm
Parallel beam (recommended)	440 mm ... 3,500 mm
3 x cross beam (recommended)	440 mm ... 3,500 mm
<b>Blind zone</b>	
Distance from 1st Beam to leading edge of housing (connection side)	4.6 mm
Distance from last beam to leading edge of housing (top)	4.6 mm <sup>1)</sup>
<b>Detection height</b>	1,600 mm
<b>Beam separation</b>	10 mm
<b>Optical light exit</b>	Flat
<b>Detection capability</b>	
Minimum detectable object (MDO), parallel beam	15 mm <sup>2)</sup>

<sup>1)</sup> For a detection height < 700 mm, the measured value can vary by up to 1 mm from the measured values specified here.

<sup>2)</sup> MDO: Minimum detectable size of an arbitrarily shaped object.

<sup>3)</sup> Depends on the sensing range / number of beams / cross beam.

Minimum detectable object (MDO), 3 x cross beam	≥ 9 mm <sup>2)</sup>
<b>Factory setting</b>	
Beam function	Parallel beam
Pin 2 (MF)	Teach-in input
Pin 4 (OUT)	Object detection output = "HIGH"
IO-Link (process data)	Q <sub>L</sub> /Q <sub>int</sub> Status, System status, Beam status
Teach-in (default)	Auto teach-in
<b>Adjustment</b>	
IO-Link	For configuring the sensor parameters and Smart Task functions
<b>Emitted beam</b>	
Light source	LED
Type of light	Infrared light
Number of beams	160
<b>LED key figures</b>	
Normative reference	EN 62471:2008-09   IEC 62471:2006, modified
LED risk group marking	Free group
Wave length	850 nm
Average service life	Average service life: 100,000 h at T <sub>U</sub> = +25 °C
<b>Time specifications</b>	
Initialization time	0.4 s ... 2 s <sup>3)</sup>
Teach-in time	0.75 s ... 50 s <sup>3)</sup>
Scan time, parallel beam	7.1 ms
Scan time, cross beam	14.1 ms
Repeatability, parallel beam	7.1 ms
Repeatability, cross beam	21.2 ms
Minimum dwell time, parallel beam	14.1 ms
Minimum dwell time, cross beam	28.2 ms
Max. response time, parallel beam	23.3 ms
Max. response time, cross beam	43.6 ms
<b>Type of synchronization</b>	Optical (2 beams)

<sup>1)</sup> For a detection height < 700 mm, the measured value can vary by up to 1 mm from the measured values specified here.

<sup>2)</sup> MDO: Minimum detectable size of an arbitrarily shaped object.

<sup>3)</sup> Depends on the sensing range / number of beams / cross beam.

## Communication interface

<b>IO-Link</b>	✓, V1.1
Data transmission rate	COM3 (230,4 kBaud)
Maximum cable length	20 m
Cycle time	2.3 ms
Process data length	32 Byte

## Electrical data

<b>Supply voltage <math>U_B</math></b>	DC 18 V DC ... 30 V DC <sup>1)</sup>
<b>Ripple</b>	$\leq 1.3 V_{pp}$
<b>Power consumption</b>	
Sender	$\leq 47 \text{ mA}^{2)}$
Receiver	$\leq 135 \text{ mA}^{2)}$
<b>Digital output</b>	
Number	2
Type	Push-pull: PNP/NPN
Output signal voltage HIGH/LOW	$U_B - 3 \text{ V} / < 3 \text{ V}$
Output load, Inductive	1 H
Output load, capacitive	100 nF
Output current $I_{max.}$	100 mA
Output current, rest	< 0.5 mA
<b>Digital input</b>	
Number	1
Input signal voltage HIGH/LOW	>15 V / <5 V
<b>Protection class</b>	III <sup>3)</sup>
<b>UL File No.</b>	NRKH.E181493 & NRKH7.E181493
<b>Circuit protection</b>	$U_V$ connections, reverse polarity protected Output Q short-circuit protected Outputs overcurrent and short-circuit protected

<sup>1)</sup> Without load.

<sup>2)</sup> At 24 V.

<sup>3)</sup> EN 61140.

## Mechanical data

<b>Dimensions (W x H x D)</b>	
Width	11.8 mm
Height	1,599.2 mm
Depth	24.1 mm
<b>Connection type</b>	Cable with M12 male connector, 4-pin
<b>Connection type Detail</b>	
Cable diameter	3.4 mm
Conductor cross section	0.14 mm <sup>2</sup>
Length of cable	150 mm
Cable material	PVC
<b>Material</b>	
Housing	Aluminumplastic
Front screen	PMMA
<b>Weight</b>	2,160 g
<b>Overvoltage protection (required)</b>	1

## Ambient data

<b>Enclosure rating</b>	IP65, IP67 <sup>1)</sup>
<b>Ambient temperature, operation</b>	-25 °C ... +55 °C
<b>Ambient temperature, storage</b>	-25 °C ... +70 °C
<b>Ambient light immunity</b>	Indirect: 50,000 lx <sup>2)</sup>
<b>Shock resistance</b>	10 g, 16 ms, DIN EN 60068-2-27
<b>Vibration resistance</b>	10-150 Hz 0.5 mm, IEC 60068-2-6
<b>Air humidity</b>	≤ 96 %, Relative humidity (no condensation)
<b>Electromagnetic compatibility (EMC)</b>	EN 61000-6-2, EN 61000-6-4

<sup>1)</sup> Operating in outdoor condition only with a external protection housing.

<sup>2)</sup> Sunlight.

## Smart Task

<b>Smart Task name</b>	Base logics
<b>Logic function</b>	Direct AND OR
<b>Timer function</b>	Deactivated On delay Off delay ON and OFF delay Impulse (one shot)
<b>Switching signal</b>	
Switching signal Q <sub>L1</sub>	Switching output
Switching signal Q <sub>L2</sub>	Switching output, external input

## Diagnosis

<b>Diagnostics functions</b>	
Device state	Hardware error, temperature warning, operating hours warning
Communication state	Pin short-circuit error, invalid process data
Status of the light signal	Teach error, synchronization error, quality-of-run alarm
Alarm output	Yes

## Classifications

<b>ECLASS 5.0</b>	27270910
<b>ECLASS 5.1.4</b>	27270910
<b>ECLASS 6.0</b>	27270910
<b>ECLASS 6.2</b>	27270910
<b>ECLASS 7.0</b>	27270910
<b>ECLASS 8.0</b>	27270910
<b>ECLASS 8.1</b>	27270910
<b>ECLASS 9.0</b>	27270910
<b>ECLASS 10.0</b>	27270910
<b>ECLASS 11.0</b>	27270910
<b>ECLASS 12.0</b>	27270910
<b>ETIM 5.0</b>	EC002549

<b>ETIM 6.0</b>	EC002549
<b>ETIM 7.0</b>	EC002549
<b>ETIM 8.0</b>	EC002549
<b>UNSPSC 16.0901</b>	39121528

**Dimensional drawing** (Dimensions in mm (inch))

Dimensional drawing, sensor

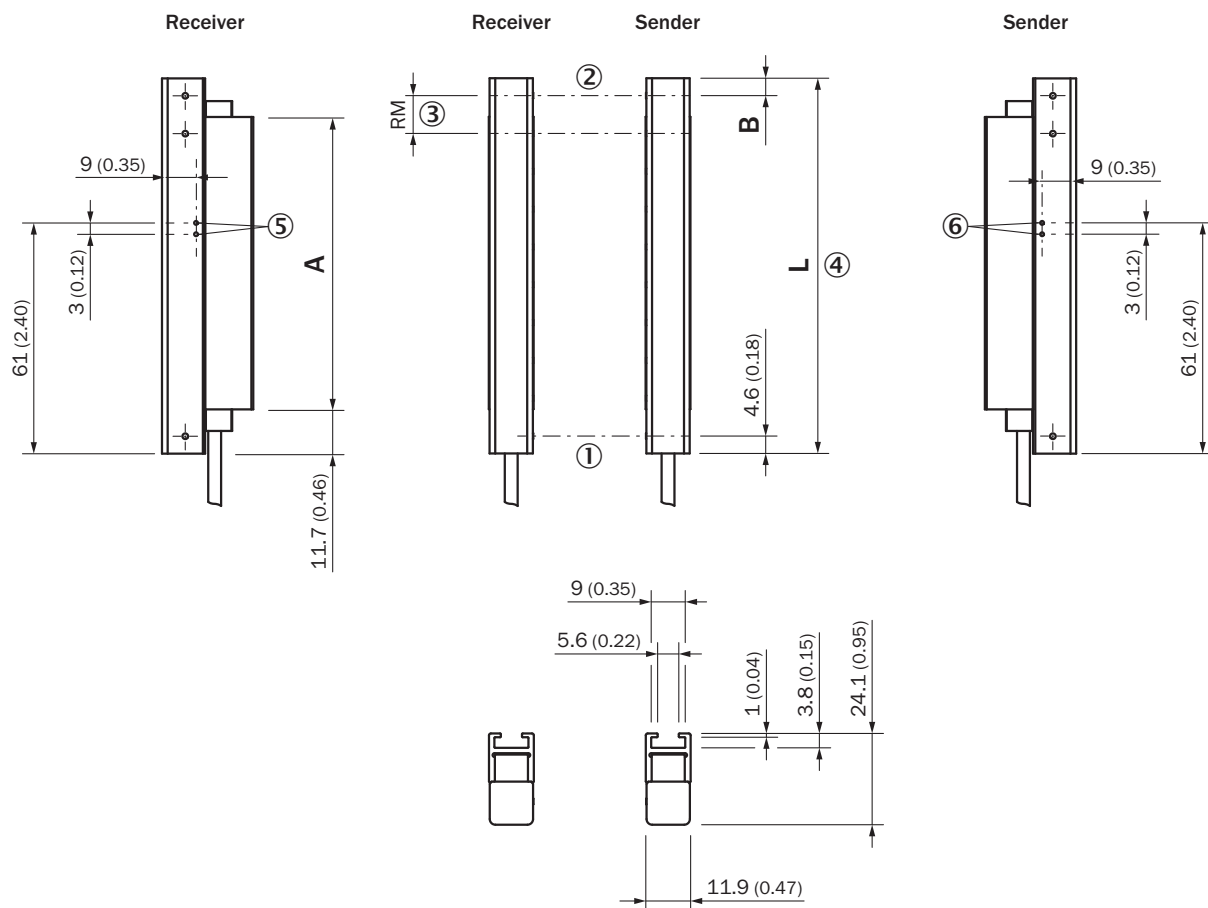

SLGxxx-xxxFxxxxxx

- ① First beam
- ② Last beam
- ③ Beam separation (RM)
- ④ Housing length
- ⑤ LED display receiver
- ⑥ LED display sender

Dimensional drawing, connection type



Cable with M12 male connector

- ① Connection (see technical data for length of cable)
- ② Receiver
- ③ Sender

Dimensions in mm (inch)		
	Length of stabilizer <b>A</b>	Housing length <b>L</b>
SLGxxx- <b>01</b> xxxxxxxx	77 (3.03)	99,2 (3.91)
SLGxxx- <b>02</b> 0xxxxxxxx	178 (7.01)	199,2 (7.84)
SLGxxx- <b>03</b> 0xxxxxxxx	276 (10.87)	299,2 (11.78)
SLGxxx- <b>04</b> 0xxxxxxxx	376 (14.8)	399,2 (15.72)
SLGxxx- <b>05</b> 0xxxxxxxx	475 (18.7)	499,2 (19.65)
SLGxxx- <b>06</b> 0xxxxxxxx	576 (22.68)	599,2 (23.6)
SLGxxx- <b>07</b> 0xxxxxxxx	676 (26.61)	699,2 (27.53)
SLGxxx- <b>08</b> 0xxxxxxxx	776 (30.55)	799,2 (31.46)
SLGxxx- <b>100</b> xxxxxxxx	975 (38.39)	999,2 (39.34)
SLGxxx- <b>120</b> xxxxxxxx	1.175 (46.26)	1.199,2 (47.21)
SLGxxx- <b>140</b> xxxxxxxx	1.374 (54.09)	1.399,2 (55.09)
SLGxxx- <b>160</b> xxxxxxxx	1.574 (61.97)	1.599,2 (62.96)
SLGxxx- <b>180</b> xxxxxxxx	1.774 (69.84)	1.799,2 (70.83)
SLGxxx- <b>20</b> 0xxxxxxxx	1.973 (77.68)	1.999,2 (78.71)
SLGxxx- <b>220</b> xxxxxxxx	2.173 (85.55)	2.199,2 (86.58)
SLGxxx- <b>240</b> xxxxxxxx	2.372 (93.39)	2.399,2 (94.46)
	Distance: Housing edge - last beam <b>B<sup>1)</sup></b>	
SLG <b>10</b> x-xxxxxxxxxxx	4,6 (0.18)	
SLG <b>25</b> x-xxxxxxxxxxx	19,6 (0.77)	
SLG <b>50</b> x-xxxxxxxxxxx	44,6 (1.76)	

<sup>1)</sup> for detection height less than 700 mm, the dimension deviates up to 1 mm from the dimensions specified here.

### Pin assignment

Pin assignment



M12 male connector, 4-pin, A-coding

- ① Receiver
- ② Sender

### Connection diagram

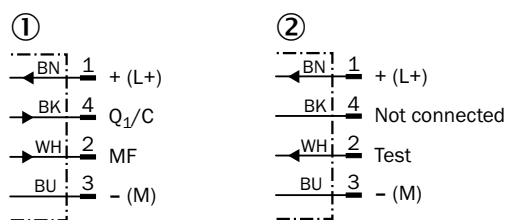

cd-543

- ① Receiver
- ② Sender

### Instruction for installation

Minimum distance to reflective materials



Depending on the sensing range, make sure that there are no reflective objects in the field of view of the light grid pair

- ① Minimum distance (safe)
- ② Minimum distance (typical)



Minimum distance between 2 light grids



If not installed in opposition, make sure the minimum distance between the two light grid pairs is adhered to

- ① Minimum distance (safe)
- ② Minimum distance (typical)

### Detection capability

Minimum detectable object (MDO)



$d_{LG}$  = Installed working distance between sender and receiver  
 $d$  = Distance to sender or receiver related to the installed working distance

### Functional principle



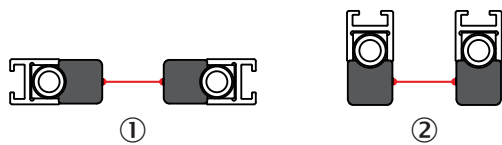

Slim & Flat



- ① Slim model = light emission on narrow side
- ② Flat model = light emission on broad side

## Recommended accessories

Other models and accessories → [www.sick.com/SLG-2](http://www.sick.com/SLG-2)

	Brief description	Type	Part no.
Connection modules			
	External, passive control unit with one pushbutton and three LEDs. Cable with male connector M12, 4-pin; cable material: PUR; housing material: plastic, TPU, reinforced; supply voltage: DC 10 V DC ... 30 V DC; current I <sub>max.</sub> : 510 mA; protection class: III (EN 61140); EMC: EN 61000-6-2, EN 61000-6-4; ambient temperature operation: -25 °C ... +55 °C; ambient temperature storage: -25 °C ... +70 °C	ECU1-2121AAZZZ	2118078
Distributors			
	<ul style="list-style-type: none"> <li>• <b>Connection type head A:</b> Male connector, M12, 5-pin, A-coded</li> <li>• <b>Connection type head B:</b> Female connector, M12, 5-pin, A-coded</li> <li>• <b>Connection type head C:</b> Female connector, M12, 3-pin, A-coded</li> <li>• <b>Signal type:</b> Sensor/actuator cable</li> <li>• <b>Description:</b> Sensor/actuator cable</li> <li>• <b>Application:</b> Zones with oils and lubricants</li> </ul>	YM2A15-000S01FY2A5	2099606
Mounting brackets and plates			
	4 pieces, Mounting bracket for switching automation light grids, SLG-2	BEF-SLG2-SET1	2111623
Plug connectors and cables			
	<ul style="list-style-type: none"> <li>• <b>Connection type head A:</b> Female connector, M12, 4-pin, straight, A-coded</li> <li>• <b>Connection type head B:</b> Flying leads</li> <li>• <b>Signal type:</b> Sensor/actuator cable</li> <li>• <b>Cable:</b> 5 m, 4-wire, PUR, halogen-free</li> <li>• <b>Description:</b> Sensor/actuator cable, unshielded</li> <li>• <b>Application:</b> Zones with oils and lubricants, Drag chain operation, Robot</li> </ul>	YF2A14-050UB3XLEAX	2095608
	<ul style="list-style-type: none"> <li>• <b>Connection type head A:</b> Female connector, M12, 4-pin, straight, A-coded</li> <li>• <b>Connection type head B:</b> Male connector, M12, 4-pin, straight, A-coded</li> <li>• <b>Signal type:</b> Sensor/actuator cable</li> <li>• <b>Cable:</b> 5 m, 4-wire, PUR, halogen-free</li> <li>• <b>Description:</b> Sensor/actuator cable, unshielded</li> <li>• <b>Application:</b> Zones with oils and lubricants, Drag chain operation, Robot</li> </ul>	YF2A14-050UB3M2A14	2096001

## SICK AT A GLANCE

SICK is one of the leading manufacturers of intelligent sensors and sensor solutions for industrial applications. A unique range of products and services creates the perfect basis for controlling processes securely and efficiently, protecting individuals from accidents and preventing damage to the environment.

We have extensive experience in a wide range of industries and understand their processes and requirements. With intelligent sensors, we can deliver exactly what our customers need. In application centers in Europe, Asia and North America, system solutions are tested and optimized in accordance with customer specifications. All this makes us a reliable supplier and development partner.

Comprehensive services complete our offering: SICK LifeTime Services provide support throughout the machine life cycle and ensure safety and productivity.

For us, that is “Sensor Intelligence.”

## WORLDWIDE PRESENCE:

Contacts and other locations –[www.sick.com](http://www.sick.com)