



Adjustable roller lever  
KMF

Product designation

Product type designation

**General characteristics**

Material

Housing	Aluminium-zinc alloy
Roller	Rubber

**Contact characteristics**

Type of contact		2NO+1NC Slow action
Thermal current I <sub>th</sub>	A	10
IEC/EN 60947-5-1 designation		A300 Q300
Rated insulation voltage U <sub>i</sub>	V	440
Rated impulse withstand voltage U <sub>imp</sub>	kV	4
Short-circuit protection with fuse	Class/A	10 gG/SC QUICK FUSE
Switching speed	min	m/s 0.5
	max	m/s 1.5
IEC Conventional free air thermal current I <sub>th</sub>	A	10
Resistance per pole (average value)	mΩ	<10

**Mechanical features**

Operating head fixing		Locking bayonet insert
Operating torque	Ncm	3
	ozin	4.25
Tightening torque (Max)		
Switch fixing	Nm	2.5
	lbin	22.1
Contact terminals	Nm	0.8
	lbin	7
Body lid screw fixing	Nm	0.8
	lbin	7
Conductor section		
AWG/Kcmil	min	16
	max	14
IEC	min	mm <sup>2</sup> 1 or 2
	max	mm <sup>2</sup> 2.5

Cable connection	Self-releasing screw terminal
Cable entry	M20 on the bottom

**Operations**

Mechanical life	cycles	<10000000
Mechanical operation	cycles/h	3600

**Ambient conditions**

Temperature	Operating temperature	min	°C	-25
		max	°C	+70
	Storage temperature	min	°C	-40
		max	°C	+70

**Resistance & Protection**

IP degree	Terminals	IP20
	Body housing	IP65
Pollution degree		3

**Dimensions**

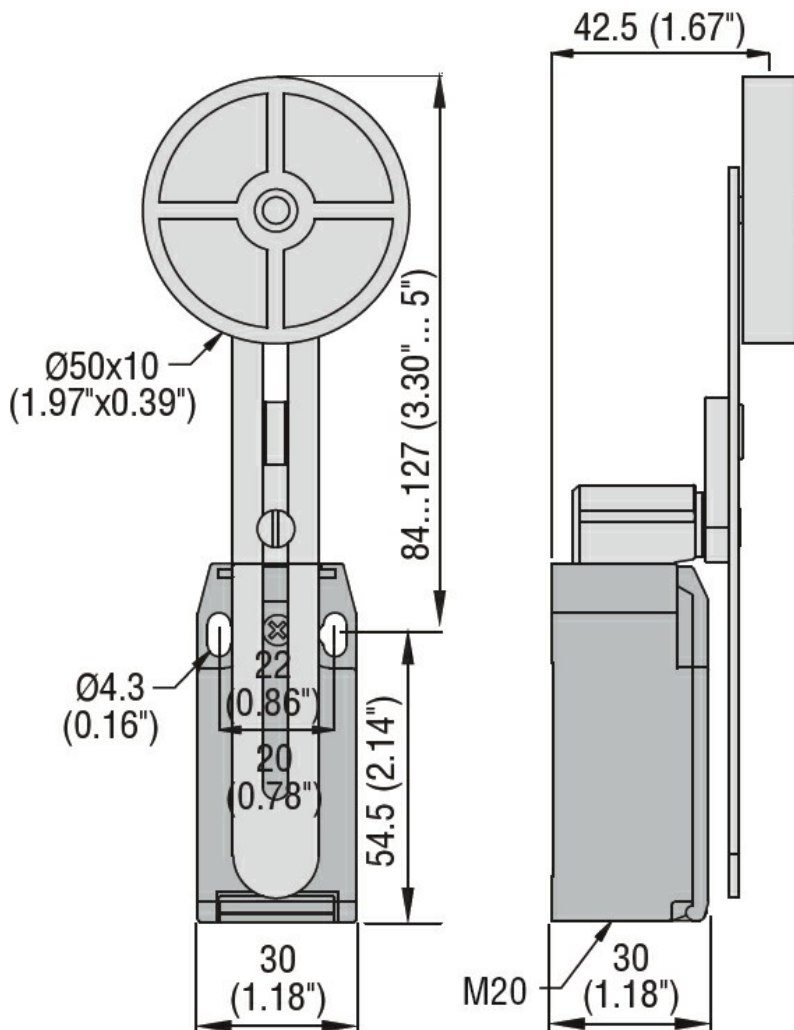

**Wiring diagrams**

## Slow action

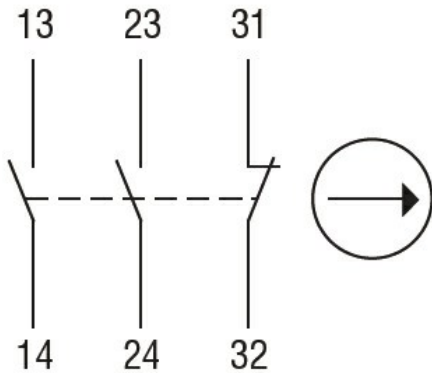

**2NO + 1NC**

### Certifications and compliance

#### Compliance

CSA C22.2 n° 14

EN 50047

IEC/EN 60204-1

IEC/EN 60947-1

IEC/EN 60947-5-1

UL508

#### Certificates

CCC

cULus

EAC

### ETIM classification

ETIM 8.0

EC000030 - End  
switch