



Product designation
Product type designation

Power contactor
BF40

Contact characteristics

Number of poles	Nr.	4
Rated insulation voltage U _i IEC/EN	V	1000
Rated impulse withstand voltage U _{imp}	kV	8
Operational frequency	min	Hz 25
	max	Hz 400
IEC Conventional free air thermal current I _{th}	A	70
Operational current I _e	AC-1 (≤40°C)	A 70
	AC-1 (≤55°C)	A 60
	AC-1 (≤70°C)	A 50
	AC-3 (≤440V ≤55°C)	A 40
	AC-4 (400V)	A 24
Rated operational current AC-3 (T≤55°C)	230V	A 40
	400V	A 40
	415V	A 40
	440V	A 40
	500V	A 33
	690V	A 32
	1000V	A 21
Rated operational power AC-1 (T≤40°C)	230V	kW 26
	400V	kW 46
	500V	kW 58
	690V	kW 79
IEC max current I _e in DC1 with L/R ≤ 1ms with 1 poles in series	≤24V	A 40
	48V	A 35
	75V	A 30
	110V	A 8
	220V	A –
IEC max current I _e in DC1 with L/R ≤ 1ms with 2 poles in series	≤24V	A 48
	48V	A 48
	75V	A 45
	110V	A 42
	220V	A 5
IEC max current I _e in DC1 with L/R ≤ 1ms with 3 poles in series	≤24V	A 48
	48V	A 48
	75V	A 48

	110V	A	44
	220V	A	56
<hr/>			
IEC max current I _e in DC1 with L/R ≤ 1ms with 4 poles in series			
	≤24V	A	–
	48V	A	–
	75V	A	–
	110V	A	–
	220V	A	70
<hr/>			
IEC max current I _e in DC3-DC5 with L/R ≤ 15ms with 1 poles in series			
	≤24V	A	27
	48V	A	23
	75V	A	19
	110V	A	3
	220V	A	–
<hr/>			
IEC max current I _e in DC3-DC5 with L/R ≤ 15ms with 2 poles in series			
	≤24V	A	32
	48V	A	30
	75V	A	27
	110V	A	22
	220V	A	5
<hr/>			
IEC max current I _e in DC3-DC5 with L/R ≤ 15ms with 3 poles in series			
	≤24V	A	40
	48V	A	40
	75V	A	38
	110V	A	27
	220V	A	32
<hr/>			
IEC max current I _e in DC3-DC5 with L/R ≤ 15ms with 4 poles in series			
	≤24V	A	–
	48V	A	–
	75V	A	–
	110V	A	–
	220V	A	40
<hr/>			
Short-time allowable current for 10s (IEC/EN60947-1)		A	400
<hr/>			
Protection fuse			
	gG (IEC)	A	100
	aM (IEC)	A	50
<hr/>			
Making capacity (RMS value)		A	400
<hr/>			
Breaking capacity at voltage			
	440V	A	320
	500V	A	265
	690V	A	256
<hr/>			
Resistance per pole (average value)		mΩ	0.8
<hr/>			
Power dissipation per pole (average value)			
	I _{th}	W	3.9
	AC-3	W	1.3
<hr/>			
Tightening torque for terminals			
	min	Nm	4
	max	Nm	5
	min	I _{bin}	2.95
	max	I _{bin}	3.69
<hr/>			
Tightening torque for coil terminal			
	min	Nm	0.8
	max	Nm	1

	min	Ibin	0.8
	max	Ibin	0.74
Max number of wires simultaneously connectable		Nr.	2
Conductor section			
AWG/Kcmil			
	max		2
Flexible w/o lug conductor section			
	min	mm ²	1.5
	max	mm ²	35
Flexible c/w lug conductor section			
	min	mm ²	1.5
	max	mm ²	35
Power terminal protection according to IEC/EN 60529			IP20 front
Mechanical features			
Operating position	normal allowable		Vertical plan ±30°
Fixing			Screw / DIN rail 35mm
Weight		g	1240
Conductor section			
AWG/kcmil conductor section			
	max		2
Operations			
Mechanical life		cycles	15000000
Electrical life		cycles	1500000
Safety related data			
Performance level B10d according to EN/ISO 13489-1			
	rated load	cycles	1500000
	mechanical load	cycles	15000000
Mirror contacts according to IEC/EN 60947-4-1			yes
EMC compatibility			yes
AC coil operating			
Rated AC voltage at 60Hz		V	460
AC operating voltage			
of 60Hz coil powered at 60Hz			
pick-up	min	%Us	80
	max	%Us	110
drop-out	min	%Us	20
	max	%Us	55
AC average coil consumption at 20°C			
of 60Hz coil powered at 60Hz			
	in-rush	VA	210
	holding	VA	15
Dissipation at holding ≤20°C 50Hz		W	5
Max cycles frequency			
Mechanical operation		cycles/h	3600
Operating times			
Average time for Us control			
in AC			
			Closing NO

		min	ms	12
		max	ms	28
	Opening NO			
		min	ms	8
		max	ms	22
<hr/>				
in DC				
	Closing NO			
		min	ms	40
		max	ms	85
	Opening NO			
		min	ms	20
		max	ms	55

UL technical data

Full-load current (FLA) for three-phase AC motor

at 480V	A	40
at 600V	A	32

Yielded mechanical performance

for single-phase AC motor

110/120V	HP	3
230V	HP	7.5

for three-phase AC motor

200/208V	HP	10
220/230V	HP	15
460/480V	HP	30
575/600V	HP	30

General USE

Contactor

AC current	A	70
------------	---	----

Short-circuit protection fuse, 600V

High fault

Short circuit current	kA	100
Fuse rating	A	150
Fuse class		J

Standard fault

Short circuit current	kA	5
Fuse rating	A	150
Fuse class		RK5

Ambient conditions

Temperature

Operating temperature

min	°C	-50
max	°C	70

Storage temperature

min	°C	-60
max	°C	80

Max altitude

m	3000
---	------

Resistance & Protection

Pollution degree

3

Dimensions

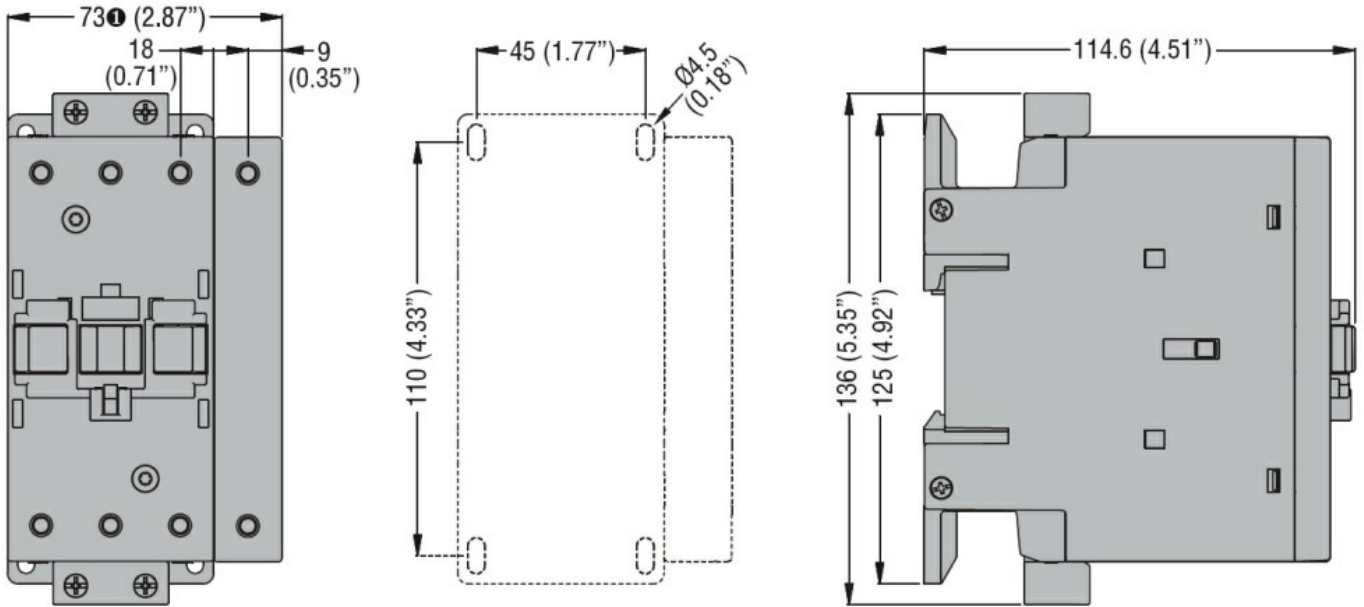

① BF80T2 82mm/3.23"

Wiring diagrams

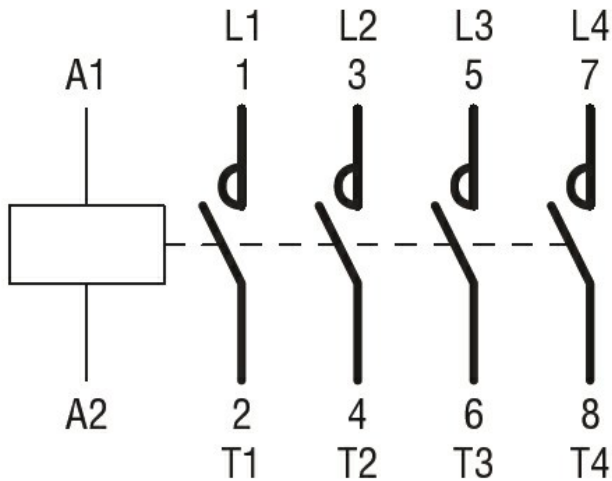

Certifications and compliance

Compliance

CSA C22.2 n° 60947-1
CSA C22.2 n° 60947-4-1
IEC/EN/BS 60947-1
IEC/EN/BS 60947-4-1
UL 60947-1
UL 60947-4-1

Certificates

CCC
cULus

ETIM classification

ETIM 8.0

EC000066 -
Power contactor,
AC switching