

ENGLISH	DIE INSTALLATION	
DEUTSCH	INSTALLATION DES CRIMPSTEMPELS	
FRANÇAISE	INSTALLATION DU POINÇON	
ITALIANA	INSTALLAZIONE DADI	
ESPAÑOL	INSTALACIÓN DE LOS DADOS	
ĚESKÝ	VLOŽENÍ MATRICE	
NEDERLANDSE	INSTALLEREN VAN DE MATRIJS	
DANSKE	INSTALLATION AF MATRICE	
SVENSKA	FORMINSTALLATION	
SUOMEN	KAAPELIKENGÄN ASENTAMINEN	
NORSK	PRESS-STEMPEL-INSTALLASJON	

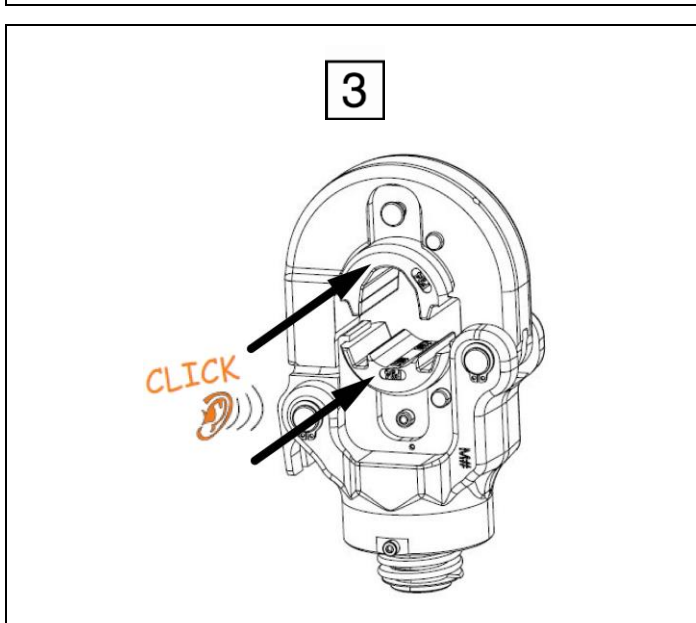

For 1 AWG using F87-18 (18mm length) ferrules, the ferrule must be double crimped as shown below to achieve a UL Listed/CSA Certified termination.

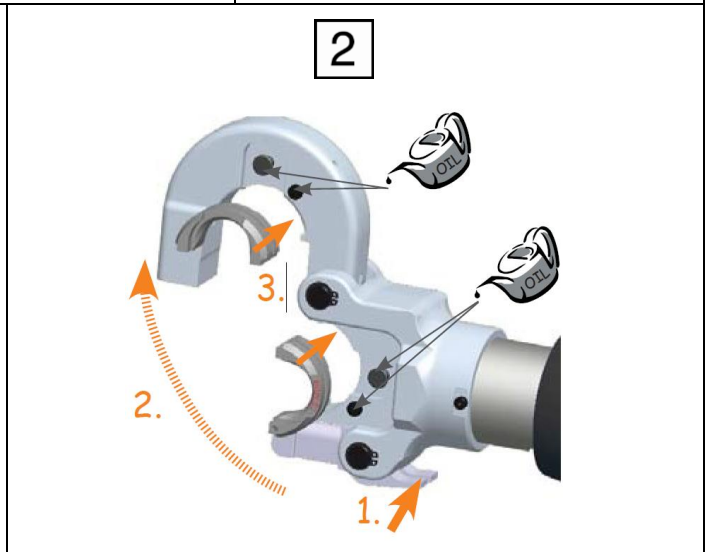
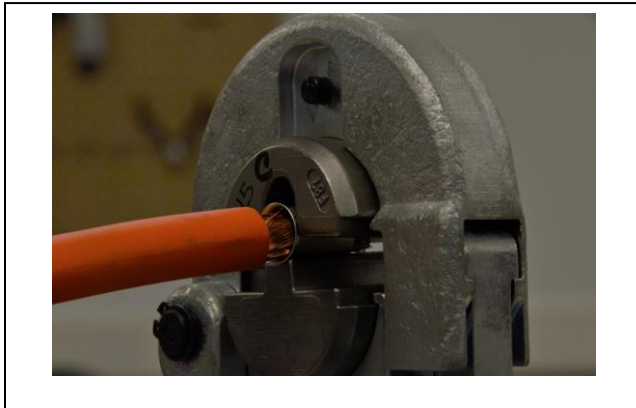

FOR SINGLE CRIMP: Crimp ferrule using a standard crimping action – Ferrule funnel against die set, cable insulation against funnel. (Note: Insulation pulled back only to show detail as shown above.)



FOR DOUBLE CRIMP (F87-18 1 AWG only): Remove crimped ferrule and rotate 180° and re-insert as shown. Re-crimp ferrule. (Note: Insulation pulled back only to show detail as shown above.)

CRIMP POCKET GO/NO GO GAGE DIMENSIONS

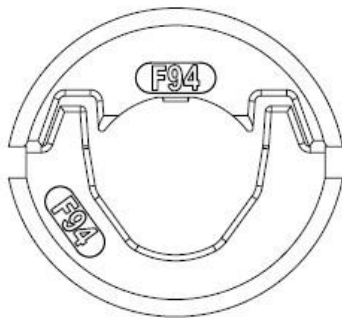
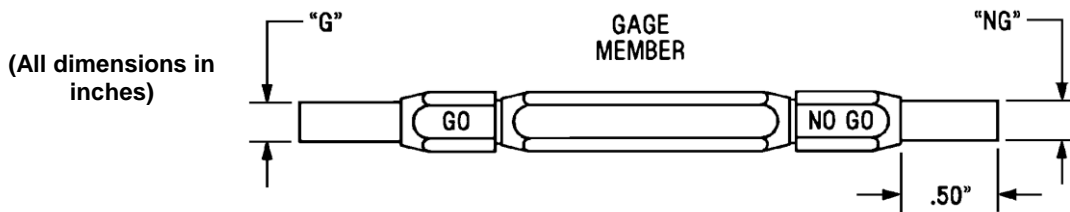

Die P/N	GO Dia. [in.]	NO GO Dia. [in.]
CD-920-F87	0.237	0.257
CD-920-F89	0.366	0.386
CD-920-F90	0.440	0.460
CD-920-F91	0.497	0.517
CD-920-F92	0.543	0.563
CD-920-F93	0.663	0.683
CD-920-F94	0.707	0.727

Email:
techsupport@panduit.com

EU Website:
www.panduit.com/emea

EU Email:
emeatoolservicecenter@panduit.com



www.panduit.com

Technical Support
Tel: 1-800-777-3300

Panduit Europe • EMEA Service Center
Almelo, Netherlands
Tel: +31 546 580 452 • Fax: +31 546 580 441