



Product designation				Power contactor
Product type designation				BFD80
Contact characteristics				
Number of poles	Nr.			4
Rated insulation voltage U_i IEC/EN	V			1000
Rated impulse withstand voltage U_{imp}	kV			8
Operational frequency	min	Hz	25	
	max	Hz	400	
IEC Conventional free air thermal current I_{th}	A			115
Operational current I_e	AC-1 ($\leq 55^\circ\text{C}$)		A	0
	400V	A	115	
IEC max current I_e in DC1 with $L/R \leq 1\text{ms}$ with 4 poles in series	600V	A	100	
	800V	A	90	
	1000V	A	80	
			A	640
Short-time allowable current for 10s (IEC/EN60947-1)			A	640
Protection fuse	gG (IEC)		A	125
	aM (IEC)		A	80
Resistance per pole (average value)			m Ω	0.6
Power dissipation per pole (average value)	lth		W	7.9
Tightening torque for terminals	min	Nm	4	
	max	Nm	5	
	min	lbin	2.95	
	max	lbin	3.69	
Tightening torque for coil terminal	min	Nm	0.8	
	max	Nm	1	
	min	lbin	0.8	
	max	lbin	0.74	
Max number of wires simultaneously connectable			Nr.	2
Conductor section	AWG/Kcmil			
			max	2
Flexible w/o lug conductor section	min	mm ²	1.5	
	max	mm ²	35	
Flexible c/w lug conductor section	min	mm ²	1.5	
	max	mm ²	35	
Power terminal protection according to IEC/EN 60529				IP20 front

Mechanical features

Operating position	normal allowable	Vertical plan ±30°
Fixing		Screw / DIN rail 35mm
Weight		g 1240
Conductor section	AWG/kcmil conductor section	
	max	2

Operations

Mechanical life	cycles	15000000
-----------------	--------	----------

Safety related data

Performance level B10d according to EN/ISO 13489-1	mechanical load	cycles	15000000
EMC compatibility			yes

AC coil operating

Rated AC voltage at 60Hz	V	220
AC operating voltage		
of 60Hz coil powered at 60Hz pick-up	min %Us	80
	max %Us	110
drop-out	min %Us	20
	max %Us	55

AC average coil consumption at 20°C of 60Hz coil powered at 60Hz	in-rush holding	VA	210
		VA	15
Dissipation at holding ≤20°C 50Hz		W	5

Max cycles frequency

Mechanical operation	cycles/h	3600
----------------------	----------	------

Operating times

Average time for Us control in AC				
	Closing NO	min	ms	12
		max	ms	28
	Opening NO	min	ms	8
		max	ms	22
in DC				
	Closing NO	min	ms	40
		max	ms	85
	Opening NO	min	ms	20
		max	ms	55

UL technical data

General USE	Contactor	AC current	A	115
	4 poles in series DC1			

600V A 100

Ambient conditions

Temperature

Operating temperature

min °C -50
max °C 70

Storage temperature

min °C -60
max °C 80

Max altitude

m 3000

Resistance & Protection

Pollution degree

3

Dimensions

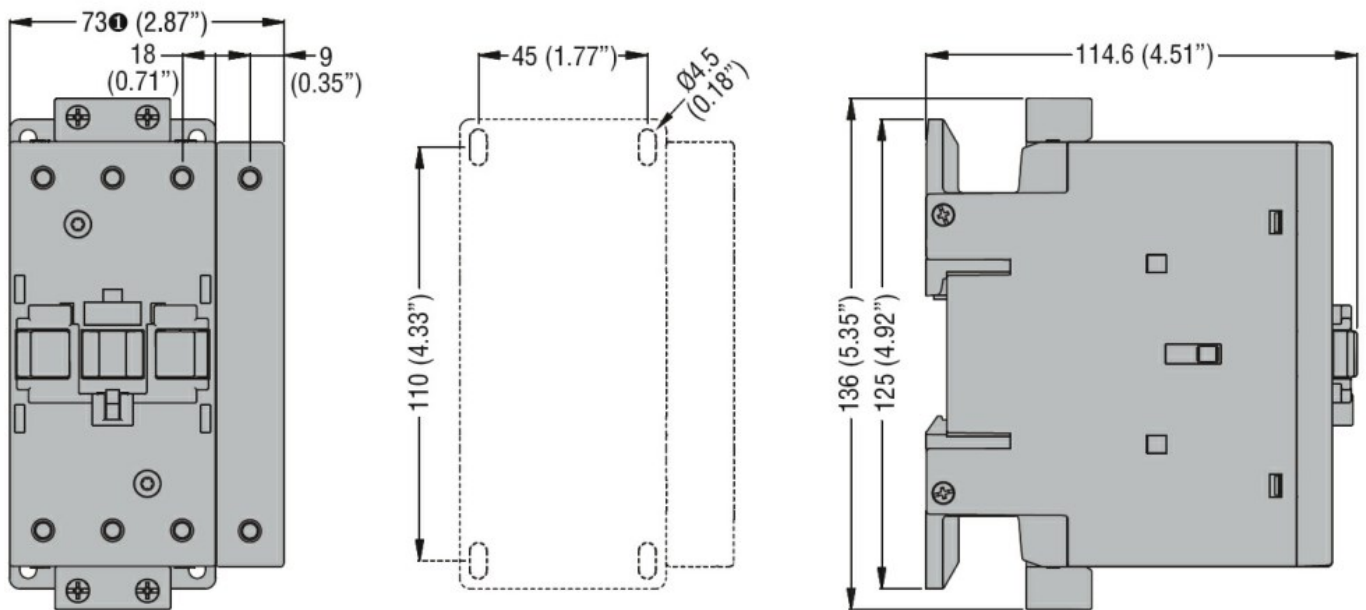

① BF80T2 82mm/3.23"

Wiring diagrams

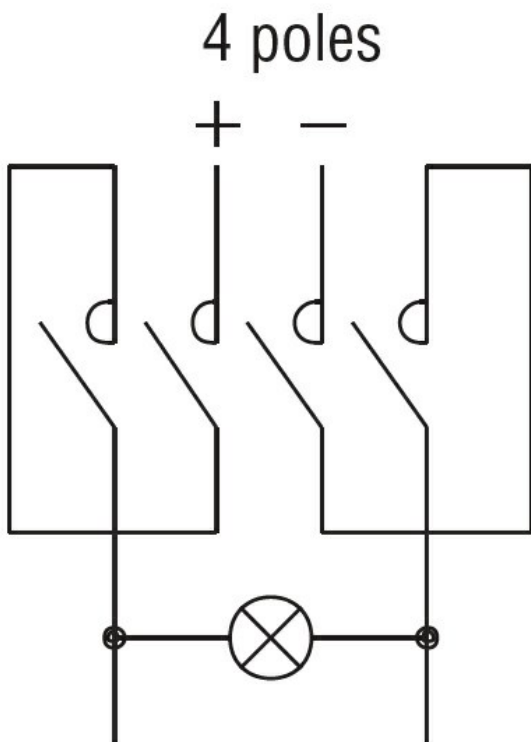

Certifications and compliance

Compliance

CSA C22.2 n° 60947-1

CSA C22.2 n° 60947-4-1

IEC/EN/BS 60947-1

IEC/EN/BS 60947-4-1

UL 60947-1

UL 60947-4-1

Certificates

cULus

ETIM classification

ETIM 8.0

EC002552 -
Power contactor,
DC switching