



TCT-2PAGE0503MZ

TCT

RESISTANCE THERMOMETER

SICK
Sensor Intelligence.



Illustration may differ



Ordering information

Type	Part no.
TCT-2PAGE0503MZ	6081737

Other models and accessories → www.sick.com/TCT

Detailed technical data

Features

Measuring range	-50 °C ... +150 °C
Sensor element	Pt100
Output signal	Pt100, 4-wire

Mechanics/electronics

Process connection	Thread G ½ B
Insertion length/diameter of probe	50 mm / 3 mm
Wetted parts	Stainless steel 1.4571
Pressure resistance	Max. 120 bar
Housing material	Stainless steel 1.4571
Connection type	M12 round connector x 1, 4-pin ¹⁾
Enclosure rating	IP67 ²⁾
Measuring current	0.3 mA ... 1 mA
Electrical safety	Protection class: III, dielectric strength: 500 V
Protection class III	✓
RoHS certificate	✓
Weight	Ca. 145 g (depending on configuration)
Initialization time	< 10 ms

¹⁾ The enclosure rating classes specified only apply while the thermometer is connected with female connectors that provide the corresponding enclosure rating.

²⁾ IP enclosure rating as per IEC 60529.

Performance

Accuracy of sensor element	Class A according to IEC 60751
Transmitter accuracy	≤ ± 1,0 % of span
Transmitter linearity	≤ 0.1 % of span
Response time	T ₅₀ : ≤ 2.8 s ¹⁾ t ₉₀ ≤ 9,1 s ¹⁾

¹⁾ Depending on sensor configuration, according to IEC 60751.

Ambient data

Ambient temperature	-40 °C ... +125 °C
Storage and transport temperature	-40 °C ... +85 °C
Shock resistance according to IEC 60751	500 g
Vibration resistance according to IEC 60751	3 g

Classifications

eCI@ss 5.0	27200208
eCI@ss 5.1.4	27200208
eCI@ss 6.0	27200208
eCI@ss 6.2	27200208
eCI@ss 7.0	27200208
eCI@ss 8.0	27200208
eCI@ss 8.1	27200208
eCI@ss 9.0	27200208
eCI@ss 10.0	27200208
eCI@ss 11.0	27200208
eCI@ss 12.0	27200208
ETIM 5.0	EC002994
ETIM 6.0	EC002994
ETIM 7.0	EC002994
ETIM 8.0	EC002994
UNSPSC 16.0901	41112211

Dimensional drawing (Dimensions in mm (inch))

Dimensional drawing: cylindrical threads

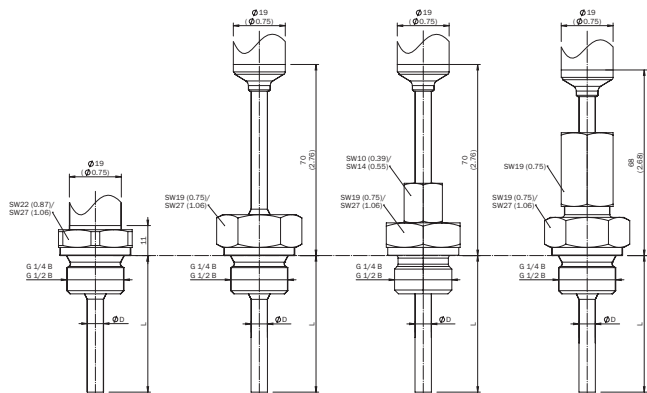

Process connections, cylindrical thread

Threaded connection up to 150 °C

Threaded connection up to 250 °C

Threaded connection and clamping connection

Threaded connection and protective pipe with thread

TCT-2

Connection type

Round connector M12 x 1, output signal Pt100

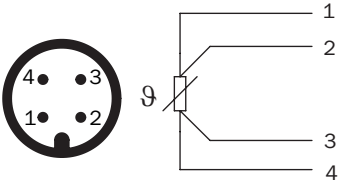

SICK AT A GLANCE

SICK is one of the leading manufacturers of intelligent sensors and sensor solutions for industrial applications. A unique range of products and services creates the perfect basis for controlling processes securely and efficiently, protecting individuals from accidents and preventing damage to the environment.

We have extensive experience in a wide range of industries and understand their processes and requirements. With intelligent sensors, we can deliver exactly what our customers need. In application centers in Europe, Asia and North America, system solutions are tested and optimized in accordance with customer specifications. All this makes us a reliable supplier and development partner.

Comprehensive services complete our offering: SICK LifeTime Services provide support throughout the machine life cycle and ensure safety and productivity.

For us, that is “Sensor Intelligence.”

WORLDWIDE PRESENCE:

Contacts and other locations –www.sick.com