



WLL180T-M434S16

WLL180

FIBER-OPTIC SENSORS

SICK
Sensor Intelligence.



Illustration may differ



Ordering information

Type	Part no.
WLL180T-M434S16	6062149

Included in delivery: BEF-WLL180 (1)

Other models and accessories → www.sick.com/WLL180

Detailed technical data

Features

Device type	Fiber-optic sensors
Device type detail	Base unit ¹⁾
Dimensions (W x H x D)	10.5 mm x 34.6 mm x 71.9 mm
Housing design (light emission)	Rectangular
Sensing range max.	0 m ... 6 m (Through-beam system) ^{2) 3)}
Sensing range	0 mm ... 400 mm, Proximity system ^{4) 5)} 0 m ... 5 m, Through-beam system ^{2) 3)}
Focus	Approx. 65° ⁶⁾
Type of light	Visible red light
Light source	LED ⁷⁾
Angle of dispersion	Approx. 65° ⁶⁾
Wave length	650 nm
Adjustment	Menu-controlled Single teach-in button Cable
Indication	7-segment
Display	LED status display / 2x 4-character digital dual displays, Set value (green indicator) and actual value (red indicator) are displayed simultaneously, display of parameters
Special features	Teach-in version without permanent storage of the teach-in value in the EEPROM

¹⁾ Up to 15 expansion units can be connected.

²⁾ Sensing range with 200 ms response time. Reduction with shorter response time (see tables LL3/WLL180T).

³⁾ LL3-TX01.

⁴⁾ Object with 90% remission (based on standard white DIN 5033). Sensing range at 200 ms response time. Reduced at shorter response times (see LL3 / WLL180T tables).

⁵⁾ LL3-DK06.

⁶⁾ See LL3 fiber-optic data.

⁷⁾ Average service life: 100,000 h at T_J = +25 °C.

Mechanics/electronics

Supply voltage U_B	12 V DC ... 24 V DC ¹⁾
Ripple	$\leq 10\%$ ²⁾
Current consumption	50 mA ³⁾
Switching output	PNP
Number of switching outputs	1
Switching mode	Light/dark switching
Switching mode selector	Manually selectable
Response time	$\leq 50\ \mu\text{s}$, $\leq 70\ \mu\text{s}$, $\leq 100\ \mu\text{s}$, $\leq 150\ \mu\text{s}$, $\leq 200\ \mu\text{s}$ ⁴⁾
Time functions	Without time delayoff delayon delayON and OFF delayone shot
Delay time	Programmable, 0 ms ... 9,999 ms
Input	Multifunctional input MF
Connection type	Male connector M8, 4-pin
Circuit protection	A ⁵⁾ B ⁶⁾ C ⁷⁾ D ⁸⁾
Protection class	III
Weight	20 g
Housing material	Plastic, ABS/PC
Enclosure rating	IP50 ⁹⁾
Items supplied	BEF-WLL180 mounting bracket
Ambient operating temperature	-25 °C ... +55 °C
Ambient temperature, storage	-40 °C ... +70 °C
UL File No.	NRKH2.E300503 & NRKH8.E300503

¹⁾ +/- 10%.

²⁾ May not exceed or fall below U_V tolerances.

³⁾ Without load.

⁴⁾ Selectable.

⁵⁾ A = V_S connections reverse-polarity protected.

⁶⁾ B = inputs and output reverse-polarity protected.

⁷⁾ C = interference suppression.

⁸⁾ D = outputs overcurrent and short-circuit protected.

⁹⁾ With correctly attached fibre-optic cable LL3 and closed protection hood.

Classifications

ECLASS 5.0	27270905
ECLASS 5.1.4	27270905
ECLASS 6.0	27270905
ECLASS 6.2	27270905
ECLASS 7.0	27270905
ECLASS 8.0	27270905
ECLASS 8.1	27270905
ECLASS 9.0	27270905

ECLASS 10.0	27270905
ECLASS 11.0	27270905
ECLASS 12.0	27270905
ETIM 5.0	EC002651
ETIM 6.0	EC002651
ETIM 7.0	EC002651
ETIM 8.0	EC002651
UNSPSC 16.0901	39121528

Adjustments

WLL180

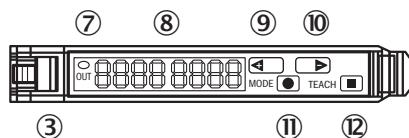

- ③ Locking the fiber-optic cables
- ⑦ LED indicator orange, lights up when switching output is active
- ⑧ Numeric display 2 x 4-digit; green: switching threshold, operating mode; red: actual value, Teach-in and function parameter
- ⑨ Step pushbutton > (manual switching threshold: higher/next function parameter)
- ⑩ Step pushbutton < (manual switching threshold: lower/previous function parameter)
- ⑪ Mode/Enter-button
- ⑫ Teach-in button

Connection type

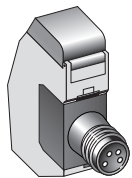

Connection diagram

Cd-140

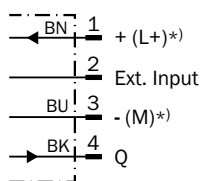

*) Only base unit

Dimensional drawing (Dimensions in mm (inch))

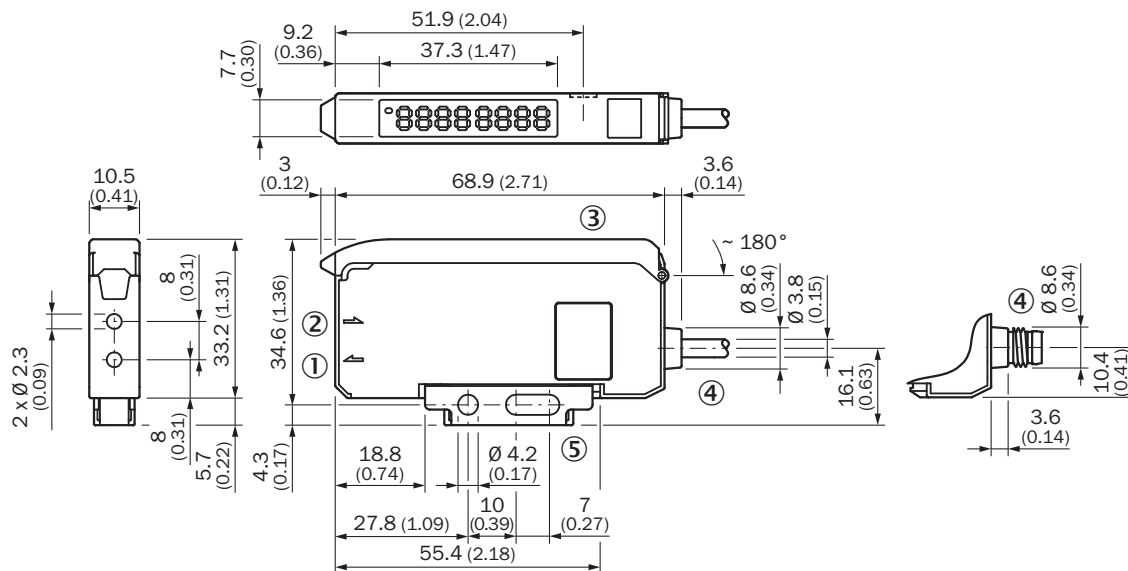

Bus type



- ① Sender LED, installation of LL3 fibre-optic cable (sender fibre)
- ② Receiver, installation of LL3 fibre optic cable (receiver fibre)
- ③ Protective hood opens approx. 180°
- ④ Connection
- ⑤ Mounting bracket, included with delivery

Recommended accessories

Other models and accessories → www.sick.com/WLL180

	Brief description	Type	Part no.
Fieldbus modules			
	EtherCAT coupler for WLL180T, KTL180 and AOD1. Features: EtherCAT; transmission rates of up to 100 Mbaud; M12 EtherCAT connection; M8 voltage supply connection, 4-pin; full read/write functionality for the process and service data of the connected sensors. See operating instructions for additional information and technical details	WI180C-EC	6068089
	PROFINET coupler for WLL180T, KTL180 and AOD1. Features: PROFINET IRT; transmission rates 10 Mbaud – 100 Mbaud; M12 PROFINET connection; M8 voltage supply connection, 4-pin; full read/write functionality for the process and service data of the connected sensors. See operating instructions for additional information and technical details	WI180C-PN	6068088
	IO-Link Smart Sensor Gateway for WLL180T, KTL180 and AOD1; Features: IO-Link; COM3; M8 connection, 4-pin; full read/write functionality for the process and service data of the connected sensors. See operating instructions for additional information and technical details	WI180C-IOA00	6071650
Plug connectors and cables			
	<ul style="list-style-type: none"> • Connection type head A: Female connector, M8, 4-pin, straight, A-coded • Connection type head B: Flying leads • Signal type: Sensor/actuator cable • Cable: 2 m, 4-wire, PVC • Description: Sensor/actuator cable, unshielded • Application: Zones with chemicals 	YF8U14-020VA3XLEAX	2095888

	Brief description	Type	Part no.
	<ul style="list-style-type: none"> • Connection type head A: Female connector, M8, 4-pin, straight, A-coded • Connection type head B: Flying leads • Signal type: Sensor/actuator cable • Cable: 5 m, 4-wire, PVC • Description: Sensor/actuator cable, unshielded • Application: Zones with chemicals 	YF8U14-050VA3XLEAX	2095889
	<ul style="list-style-type: none"> • Connection type head A: Female connector, M8, 4-pin, angled, A-coded • Connection type head B: Flying leads • Signal type: Sensor/actuator cable • Cable: 2 m, 4-wire, PVC • Description: Sensor/actuator cable, unshielded • Application: Zones with chemicals 	YG8U14-020VA3XLEAX	2095962
	<ul style="list-style-type: none"> • Connection type head A: Female connector, M8, 4-pin, angled, A-coded • Connection type head B: Flying leads • Signal type: Sensor/actuator cable • Cable: 5 m, 4-wire, PVC • Description: Sensor/actuator cable, unshielded • Application: Zones with chemicals 	YG8U14-050VA3XLEAX	2095963
Fibers			
	LL3-DB01	LL3-DB01	5308074
	LL3-DB02	LL3-DB02	5308083
	LL3-DC38	LL3-DC38	5322472
	LL3-DR11	LL3-DR11	5326000
	LL3-DT01	LL3-DT01	5308076
	LL3-DV05	LL3-DV05	5322549
	LL3-TB01	LL3-TB01	5308050
	LL3-TS40	LL3-TS40	5323971
	LL3-TV05	LL3-TV05	5322546
	LL3-TX01	LL3-TX01	5324173
	LL3-TY01	LL3-TY01	5308066

SICK AT A GLANCE

SICK is one of the leading manufacturers of intelligent sensors and sensor solutions for industrial applications. A unique range of products and services creates the perfect basis for controlling processes securely and efficiently, protecting individuals from accidents and preventing damage to the environment.

We have extensive experience in a wide range of industries and understand their processes and requirements. With intelligent sensors, we can deliver exactly what our customers need. In application centers in Europe, Asia and North America, system solutions are tested and optimized in accordance with customer specifications. All this makes us a reliable supplier and development partner.

Comprehensive services complete our offering: SICK LifeTime Services provide support throughout the machine life cycle and ensure safety and productivity.

For us, that is “Sensor Intelligence.”

WORLDWIDE PRESENCE:

Contacts and other locations –www.sick.com