

XPSMCMMX0804•

Instruction Sheet (Original Language)

10/2020

The information provided in this documentation contains general descriptions and/or technical characteristics of the performance of the products contained herein. This documentation is not intended as a substitute for and is not to be used for determining suitability or reliability of these products for specific user applications. It is the duty of any such user or integrator to perform the appropriate and complete risk analysis, evaluation and testing of the products with respect to the relevant specific application or use thereof. Neither Schneider Electric nor any of its affiliates or subsidiaries shall be responsible or liable for misuse of the information contained herein. If you have any suggestions for improvements or amendments or have found errors in this publication, please notify us.

You agree not to reproduce, other than for your own personal, noncommercial use, all or part of this document on any medium whatsoever without permission of Schneider Electric, given in writing. You also agree not to establish any hypertext links to this document or its content. Schneider Electric does not grant any right or license for the personal and noncommercial use of the document or its content, except for a non-exclusive license to consult it on an "as is" basis, at your own risk. All other rights are reserved.

All pertinent state, regional, and local safety regulations must be observed when installing and using this product. For reasons of safety and to help ensure compliance with documented system data, only the manufacturer should perform repairs to components.

When devices are used for applications with technical safety requirements, the relevant instructions must be followed.

Failure to use Schneider Electric software or approved software with our hardware products may result in injury, harm, or improper operating results.

Failure to observe this information can result in injury or equipment damage.

© 2020 Schneider Electric. All rights reserved.

Table of Contents



About the Book	5
XPSMCMX0804• Input/Output Expansion Module	7



At a Glance

Document Scope

This information is about the usage and configuration of XPSMCMX0804• input/output expansion module for the XPSMCMC10804• Modular Safety Controller.

Validity Note

The characteristics that are described in the present document should be the same as those characteristics that appear online. In line with our policy of constant improvement, we may revise content over time to improve clarity and accuracy. If you see a difference between the document and online information, use the online information as your reference.

Product Related Information

The XPSMCM• can reach a maximum Safety Integrity Level (SIL) 3 as per IEC 61508, a maximum Safety Integrity Level Claim Limit (SILcl) as per IEC 62061, and a maximum Performance Level (PL) e, category 4, as per ISO 13849-1. However, the definitive SIL and PL of the application depends on a number of safety-related components, their parameters, and the connections that are made, as per the risk analysis.

The module must be configured in accordance with the application-specific risk analysis and all the applicable standards.

Pay particular attention in conforming to any safety information, different electrical requirements, and normative standards that would apply to your adaptation.

WARNING

INSUFFICIENT SAFETY-RELATED FUNCTIONS

- Perform a risk assessment as per ISO 12100 and/or other equivalent assessment and appropriately consider all applicable regulations and standards that apply to your machine/process before using this software.
- In your risk assessment, determine all requirements regarding the Safety Integrity Level (SIL), the Performance Level (PL), and any other safety-related requirements and capabilities applicable to your machine/process.

Failure to follow these instructions can result in death, serious injury, or equipment damage.

NOTE: Configuration of the module is the sole responsibility of the installer or user.

XPSMCMX0804• Input/Output Expansion Module

Safety-related Information

NOTE: The safety-related function can be compromised if this equipment is not used for the intended purpose and in accordance with the instructions in the present document. This equipment must only be used as safety-related equipment on machines intended to protect persons, material, and installations.

DANGER

HAZARD OF ELECTRIC SHOCK, EXPLOSION OR ARC FLASH

- Disconnect all power from all equipment including connected input devices, contactors, and drives prior to removing any covers or doors, or installing or removing any accessories, hardware, cables, or wires.
- Install and use this equipment only in locations known to be non-hazardous.
- Do not use the equipment described herein to supply other, external equipment.
- Always use properly rated voltage sensing equipment to confirm that the power is removed.
- Avoid contacting terminals with hand or tools until the power has been confirmed removed.
- Follow all electrical safety regulations and standards (for example, lockout/tag-out, phase grounding, barriers) to reduce the possibility of contact with hazardous voltages in the work area.
- Remove locks, tags, barriers, temporary ground straps, and replace and secure all covers, doors, accessories, hardware, cables, and wires and confirm that a proper ground connection exists before reapplying power to the unit.
- Complete thorough hardware tests and system commissioning to verify that line voltages are not present on the control circuits before using your hardware operationally.
- Use only the specified voltage when operating this equipment and any associated products.

Failure to follow these instructions will result in death or serious injury.

DANGER

LOSS OF DESIGNATED SAFETY FUNCTION

- Install the XPSMCM• Modular Safety Controller system in an enclosure with a degree of protection of at least IP 54.
- Use a Protective Extra Low Voltage (PELV) power supply to isolate the equipment from line voltage.
- Do not directly connect the equipment to line voltage.

Failure to follow these instructions will result in death or serious injury.

DANGER

POTENTIAL FOR EXPLOSION

Install and use the Modular Safety Controller in non-hazardous locations only.

Failure to follow these instructions will result in death or serious injury.

NOTE: The observation of operating limits and duty cycles is of particular importance for equipment designed to perform a safety-related function. If this module has been subjected to electrical, mechanical, or environmental stresses in excess of its stated limits, do not use it.

WARNING

UNINTENDED EQUIPMENT OPERATION

- Do not exceed any of the rated operating limits for the equipment specified in the present document.
- Immediately cease using and replace any equipment that has or might have been subjected to conditions in excess of its rated operating limits.

Failure to follow these instructions can result in death, serious injury, or equipment damage.

WARNING

UNINTENDED EQUIPMENT OPERATION

- You must carry out a risk assessment in accordance with ISO 12100.
- Validate the entire system/machine in accordance with the required performance level and risk assessment.

Failure to follow these instructions can result in death, serious injury, or equipment damage.

User Responsibilities

The information provided in this documentation contains general descriptions and/or technical characteristics of the performance of the products contained herein. This documentation is not intended as a substitute for and is not to be used for determining suitability or reliability of these products for specific user applications. It is the duty of any such user, machine builder, or system integrator to perform the appropriate and complete risk analysis, evaluation, and testing of the products with respect to the relevant specific application or use thereof.

Neither Schneider Electric nor any of its affiliates or subsidiaries shall be responsible or liable for misuse of the information contained herein. If you have any suggestions for improvements or amendments or have found discrepancies in this publication, notify Schneider Electric. All pertinent safety regulations must be observed when installing and using this product. For reasons of safety and to help ensure compliance with documented system data, only the manufacturer should perform repairs to components.

Qualified Personnel

Electrical equipment should be installed, operated, serviced, and maintained only by qualified personnel. A qualified person is one who has skills and knowledge related to the construction and operation of this electrical equipment and its installation, and has received safety training to recognize and avoid the hazards involved.

Module and Function Description

The XPSMCMX0804• module is an input/output expansion module. The XPSMCMX0804• module can only be configured with the XPSMCMC10804• Modular Safety Controller. The XPSMCMX0804• module provides eight safety-related inputs, four solid-state safety-related outputs which can be used as four single or two dual (Output Signal Switching Device, OSSD) and four SIL 1/PL c status outputs.

The expansion module supports two inputs `NODE_ADDR0` and `NODE_ADDR1` which are used to set a physical address to the module:

	NODE_ADDR0 (Terminal 2)	NODE_ADDR1 (Terminal 3)
NODE 0	0 (or not connected)	0 (or not connected)
NODE 1	24 Vdc	0 (or not connected)
NODE 2	0 (or not connected)	24 Vdc
NODE 3	24 Vdc	24 Vdc

NOTE: Do not use the same physical address for two units of the same module reference.

NOTE: The LEDs **ADDR 1** and **ADDR 0** correspond to the `NODE_ADDR1` and `NODE_ADDR0` in this table respectively.

NOTE: The node address wiring must match the configuration settings.

Safety-Related Inputs

The XPSMCMX0804• input/output expansion module provides eight digital inputs for connection of safety-related sensors and other input devices such as emergency stop push-buttons, magnetic switches, light curtains.

Input **RESTART** (**RST**)

The **RESTART** (**RST**) signal input allows the XPSMCMX0804• module to verify an EDM (External Device Monitoring) feedback signal (series of contacts) from external contactors, and to monitor manual/automatic operation.

⚠ WARNING

UNINTENDED EQUIPMENT OPERATION

- The `RESTART` command device must be installed outside the zone of operation in a position where the zone of operation and the entire work area concerned are clearly visible.
- It must not be possible to operate the `RESTART` command device from inside the zone of operation.

Failure to follow these instructions can result in death, serious injury, or equipment damage.

Operation mode	EDM	Restart_fbk
Automatic	With K1_K2 control	
	Without K1_K2 control	
Manual	With K1_K2 control	
	Without K1_K2 control	

Output STATUS (SIL 1/PL c in Accordance with Standard EN 61508:2010)

The status outputs are configurable digital diagnostic outputs that indicate the status of safety-related inputs and/or outputs.

Four status outputs are available on the XPSMCMX0804• module. The status outputs are shared with the feedback/restart inputs of the OSSDs. To use the status outputs, the corresponding OSSD must be used with automatic reset without external feedback monitoring. For example, to use the `STATUS1` output (Terminal 7), you must program `OSSD1` (by means of the SoSafe Configurable with automatic reset without K feedback monitoring).

The status outputs are SIL 1/PL c outputs.

⚠ WARNING

INSUFFICIENT SAFETY-RELATED FUNCTIONS

Do not use status outputs for safety-related purposes greater than SIL 1/PL c (EN 61508:2010).

Failure to follow these instructions can result in death, serious injury, or equipment damage.

Output TEST

The TEST outputs are related to be used with the input circuits of the module.

The TEST outputs must be used to monitor the presence of cross circuits or short-circuits on the inputs. Connecting the test outputs helps to reach PL e in accordance with ISO 13849-1 and SILCL 3 in accordance with IEC 62061.

NOTE: These safety levels can also be obtained by applying other means of fault exclusion as described in ISO 13849-2.

NOTE: The test outputs of a specific module can only be linked to the inputs of the same module.

Each test output is able to drive a maximum of four inputs in parallel.

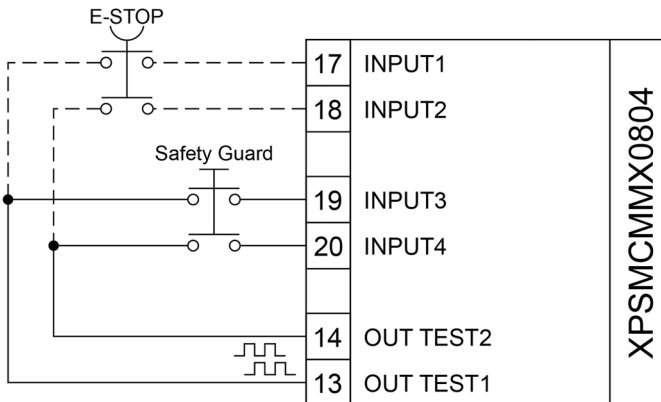

Interface Type C, class 3 according to "ZVEI CB24I Ed.2" with a maximum test pulse duration of 100 μ s.

Solid-State Safety-Related Output (OSSD)

WARNING

UNINTENDED EQUIPMENT OPERATION

Do not connect any equipment to an OSSD unless the OSSD is appropriately configured with SoSafe Configurable.

Failure to follow these instructions can result in death, serious injury, or equipment damage.

The four OSSD safety-related outputs are short-circuit protected.

The outputs are able to supply:

- In the ON condition: $(U_v - 0.6 \text{ V}) \dots U_v$ (24 Vdc \pm 20%);
- In the OFF condition: 0...2 Vrms (root mean square)

The maximum load current of 400 mA (per OSSD). The minimum resistive load is 60 Ω .

The maximum capacitive load is 0.82 μF .

The maximum inductive load is 2.4 mH.

Interface Type C, class 3 according to "ZVEI CB24I Ed.2" with a maximum test pulse duration of 100 μs .

Different output configurations (configurable with SoSafe Configurable) can be set:

- 4 single channels (1 safety-related output per channel with its corresponding feedback input).
- 2 dual channels (2 safety-related outputs with their corresponding feedback input per channel).
- 1 dual channel and 2 single channels.

The following table indicates how each OSSD output can be configured:

Automatic	The output is activated according to the configurations set by the SoSafe Configurable software, only if the corresponding <code>RESTART</code> input is connected to U_v (24 Vdc \pm 20%).
Manual	The output is activated according to the configurations set by the SoSafe Configurable software, only if the level at the corresponding <code>RESTART</code> input changes from 0 Vdc to U_v (24 Vdc \pm 20%).
Monitored	The output is activated according to the configurations set by the SoSafe Configurable software, only if the level at the corresponding <code>RESTART</code> input changes from 0 Vdc to U_v (24 Vdc \pm 20%) and back to 0 Vdc.

Terminals

Examples with maximum number of terminals. Regarding terminal designation, refer to table below.

Terminal numbers

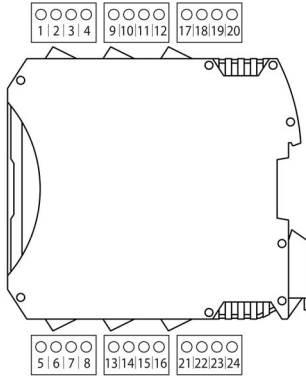

Terminal	Signal	LED	Type	Description	Operation
1	24 VDC	PWR	-	24 Vdc power supply	-
2	NODE_ADDR0	ADDR0	Input	Node selection	Input type 3 according to EN 61131-2. Maximum resistance 1.2 kΩ.
3	NODE_ADDR1	ADDR1			
4	0 VDC	PWR	-	0 Vdc power supply	-
5	OSSD1	OSSD 1	Output	Safety-related output 1	PNP active at U _v (24 Vdc ± 20%).
6	OSSD2	OSSD 2	Output	Safety-related output 2	
7	RESTART_FBK1 / STATUS1	STATUS 1	Input / output	Feedback/Restart 1 for OSSD1	Input type 3 according to EN 61131-2. Maximum resistance 1.2 kΩ.
				Configurable output 1 for OSSD1	
8	RESTART_FBK2 / STATUS2	STATUS 2	Input / output	Feedback/Restart 2 for OSSD2	Input type 3 according to EN 61131-2. Maximum resistance 1.2 kΩ.
				Configurable output 2 for OSSD2	

Terminal	Signal	LED	Type	Description	Operation
9	OSSD3	OSSD 3	Output	Safety-related output 3	PNP active at U_v (24 Vdc \pm 20%).
10	OSSD4	OSSD 4	Output	Safety-related output 4	
11	RESTART_FBK3 / STATUS3	STATUS 3	Input / output	Feedback/Restart 3 for OSSD3	Input type 3 according to EN 61131-2. Maximum resistance 1.2 k Ω .
				Configurable output 3 for OSSD3	Configurable output (SIL 1/PL c in accordance with EN 61508:2010)
12	RESTART_FBK4 / STATUS4	STATUS 4	Input / output	Feedback/Restart 4 for OSSD4	Input type 3 according to EN 61131-2. Maximum resistance 1.2 k Ω .
				Configurable output 4 for OSSD4	Configurable output (SIL 1/PL c in accordance with EN 61508:2010)
13	OUT_TEST1	-	Output	Test output for detection of short circuits/cross circuits in input circuits	PNP active at 24 Vdc.
14	OUT_TEST2	-			
15	OUT_TEST3	-			
16	OUT_TEST4	-			
17	INPUT1	IN 1	Input	Safety-related input 1	Input type 3 according to EN 61131-2. Maximum resistance 1.2 k Ω .
18	INPUT2	IN 2		Safety-related input 2	
19	INPUT3	IN 3		Safety-related input 3	
20	INPUT4	IN 4		Safety-related input 4	
21	INPUT5	IN 5		Safety-related input 5	
22	INPUT6	IN 6		Safety-related input 6	
23	INPUT7	IN 7		Safety-related input 7	
24	INPUT8	IN 8		Safety-related input 8	

Wiring Example

Category 4 wiring for XPSMCMX0804• with feedback of the contactors K1 and K2:

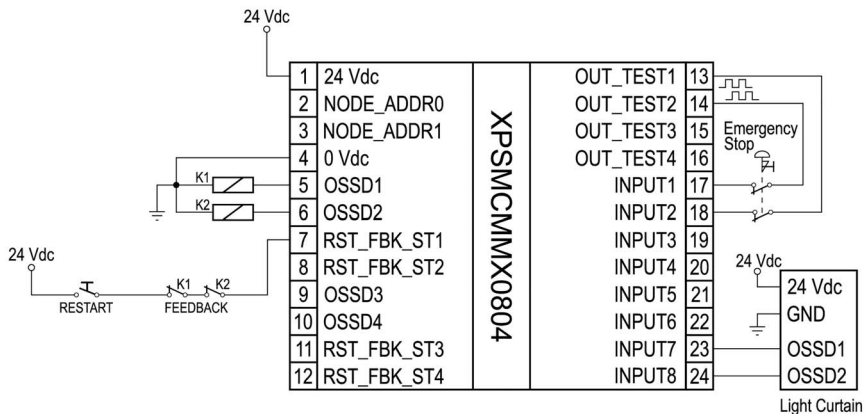

NOTE: Best practice dictates the use of fusing on the incoming 24 Vdc power, and sized appropriately for the requirements of the module.

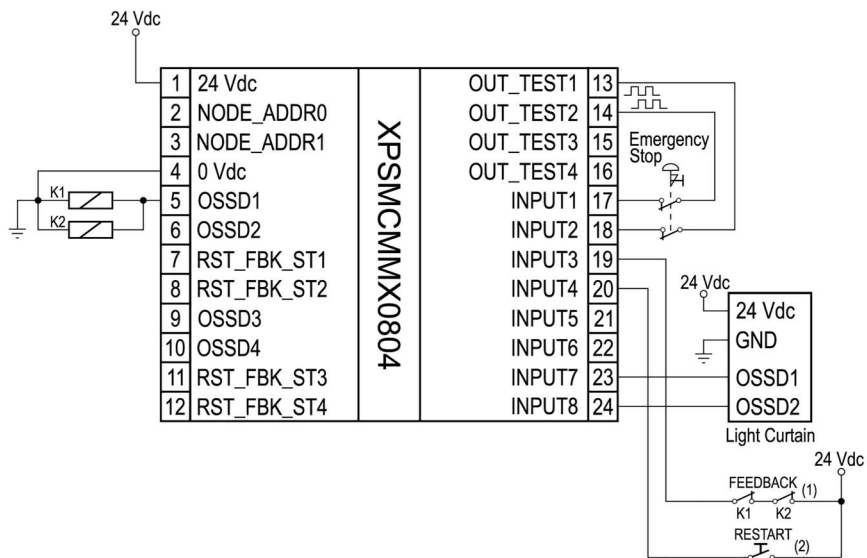

- (1) Contacts connected to the OSSD EDM functional block
- (2) Contacts connected to the USER RESTART MANUAL, USER RESTART MONITORED or MACRO RESTART MANUAL, MACRO RESTART MONITORED function block

NOTE: Best practice dictates the use of fusing on the incoming 24 Vdc power, and sized appropriately for the requirements of the module.

Dimensions

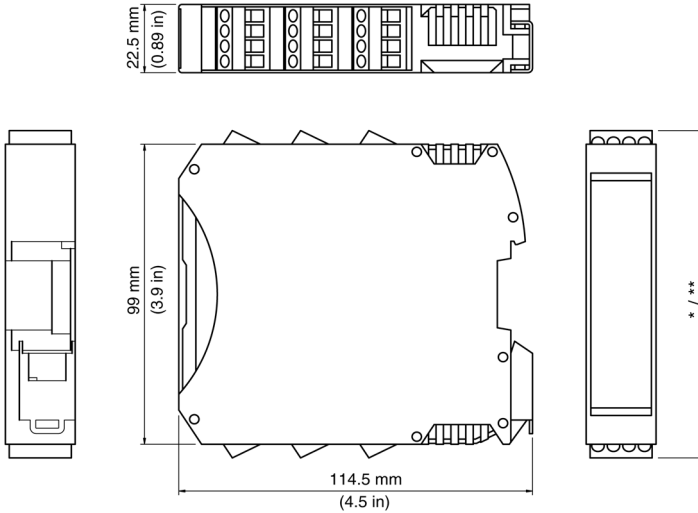









- * Screw terminals 108 mm (4.25 in)
- ** Spring terminals 118 mm (4.67 in)



Mount the modules (Modular Safety Controller and any I/O expansion modules) in an electric cabinet with an IP54 degree of protection. The minimum clearance below and above the controller is 40 mm (1.57 in). Allow at least 100 mm (3.93 in) distance between the cabinet door and the front face of the module(s). There are no clearances required on the left or right side of the module(s), but for XPSMCMDO00042A* module an additional distance to adjacent modules is mandatory (see *Modular Safety Controller, Hardware Guide*). Other equipment in proximity may require larger distances and those clearances must also be taken into account.

Technical Data

Cable types and wire sizes



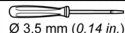



for a 5.08 pitch removable **screw** terminal block

mm in.								
mm ²	0.2...2.5	0.2...2.5	0.25...2.5	0.25...1.5	2 x 0.2...1	2 x 0.2...1.5	2 x 0.25...1	2 x 0.5...1.5
AWG	24...14	24...14	23...14	23...16	2 x 24...18	2 x 24...16	2 x 23...18	2 x 20...16

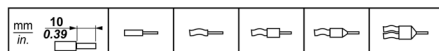
		N•m	0.5
Ø 3.5 mm (0.14 in.)		lb•in	4.42

Cable types and wire sizes

for a 5.08 pitch removable **spring** terminal block (used by XPSMCM***G).

					
mm ²	0.2...2.5	0.2...2.5	0.25...2.5	0.25...2.5	2 x 0.5...1
AWG	24...14	24...14	23...14	23...14	2 x 20...18

The following instructions concerning connection cables must be observed:

- Use 60/75 °C copper (Cu) conductor only. Maximum cable length 100 m (328 ft).
- Cables used for connections of longer than 50 m (164 ft) must have a cross-section of at least 1 mm² (AWG 16).

Housing characteristics

Housing material	Polyamide
Housing degree of protection	IP20
Terminal blocks degree of protection	IP2x
Mounting	35 mm DIN rail according to EN/IEC 60715
Mounting position	Vertical or horizontal
Dimensions (h x l x d)	<ul style="list-style-type: none"> ● with screw terminals: 108 x 22.5 x 114.5 mm (4.25 x 0.89 x 4.5 in) ● with spring terminals: 118.5 x 22.5 x 114.5 mm (4.67 x 0.89 x 4.5 in)

Module characteristics

Rated voltage	24 Vdc ± 20 % (PELV supply)
Dissipated power	3 W maximum (per module)
Overvoltage category	II
Ambient operating temperature	-10...+55 °C (14...131 °F), for vertical or horizontal mounting position
Storage temperature	-20...+85 °C (-4...185 °F)
Relative humidity	10...95%
Maximum operation altitude	2000 m (6562 ft)
Pollution degree	2
Vibration resistance (EN 61496-1)	+/- 0.35 mm (0.014 in) 10...55 Hz
Bump resistance (EN 61496-1)	10 g (16 ms half-sine)

Module-specific characteristics

Description	Electronic housing maximum 24-poles, with locking latch mounting
Mounting	DIN rail mounting with locking latch
Safety-related input (number / description)	8 / Input type 3 according to EN 61131-2. Maximum resistance 1.2 kΩ.

Module-specific characteristics	
Restart input (optional to status outputs) (number / description)	4 / EDM (External Device Monitoring) type 3 according to EN 61131-2. Maximum resistance 1.2 k Ω . Possible automatic restart function or manual operation with restart pushbutton.
Status outputs (optional to restart input) (number / description)	4 / SIL 1/PL c in accordance with standard EN 61508:2010. Maximum current per output: 100 mA, nominal voltage 24 Vdc.
Test output (number / description)	4 / For cross circuit/short circuit monitoring, maximum current 100 mA, nominal voltage 24 Vdc.
Solid-state safety-related output (OSSD) (number / description)	<p>4 / solid-state safety-related outputs PNP active high</p> <ul style="list-style-type: none"> ● Interface type C class 3 (ZVEI CB24I Ed.2) ● The outputs are able to supply: <ul style="list-style-type: none"> ○ In the ON condition: $(U_v - 0.6 \text{ V}) \dots U_v$ (24 Vdc \pm 20 %) ○ In the OFF condition: 0...2 Vrms (root mean square) ● The maximum load current of 400 mA (per OSSD) corresponds to a minimum resistive load of 60 Ω. <ul style="list-style-type: none"> ○ The maximum capacitive load is 0.82 μF. ○ The maximum inductive load is 2.4 mH. ● Test pulses are used to detect short circuits and interruptions of wires. The switch-off test pulse interval is every 650 ms, the test pulse duration is 100 μs.
Probability of Dangerous Failure per Hour (PFHd)	1.32E-08
Mean Time to Dangerous Failure (MTTFd) in years	166
Connection to expansion modules	5-way backplane expansion
Weight	0.150 kg (5.29 oz)

Checklist After Installation

The following must be verified:

Step	Action
1	Conduct a full functional test of the system (see <i>Validation</i> in the <i>Modular Safety Controller Library and Programming Guide</i> .)
2	Verify that all the cables are correctly inserted and the terminal blocks are within correct torque for screw terminals.
3	Verify that all the LED indicators are correctly illuminating for the inputs and outputs used.
4	Verify the positioning and function of all input and output sensors and actuators used with the XPSMCM•.
5	Verify the correct mounting of XPSMCM• to the DIN rail.
6	Verify that all the external indicators (lamps/beacons/sirens) are correctly functioning.