



LFP1000-N1DMB

LFP Inox

TDR LEVEL SENSOR

SICK
Sensor Intelligence.



Illustration may differ



Ordering information

| Type | Part no. |
|---------------|----------|
| LFP1000-N1DMB | 1071142 |

Other models and accessories → www.sick.com/LFP_Inox

Detailed technical data

Features

| | |
|----------------------------|---|
| Medium | Fluids |
| Measurement | Switch, Continuous |
| Design | Remote amplifier, length of cable 3.3 m |
| Probe length | 1,000 mm |
| Process pressure | -1 bar ... 16 bar |
| Process temperature | -20 °C ... +180 °C |
| UL approval | ✓ |
| RoHS certificate | ✓ |
| IO-Link | ✓ |
| EHEDG approval | ✓ |

Performance

| | |
|---|--|
| Accuracy of sensor element | ± 5 mm |
| Reproducibility | ≤ 2 mm |
| Resolution | 1 mm |
| Response time | < 400 ms ¹⁾ |
| Dielectricity constant | ≥ 5 for rod probe ≥ 1.8 with coaxial tube |
| Conductivity | No limitation |
| Deactivated area at process connection | 25 mm ²⁾ |
| Deactivated area at end of probe | ≥ 10 mm ³⁾ |
| MTTF | 194.3 years (EN ISO 13849-1) |
| Display | ✓ |

¹⁾ Dependent on measuring mode (high speed < 400 ms, high accuracy < 2,800 ms).

²⁾ With parameterized container with water under reference conditions, otherwise 40 mm.

³⁾ With water under reference conditions.

Electronics

| | |
|----------------------------|---|
| Supply voltage | 12 V DC ... 30 V DC ¹⁾ |
| Power consumption | ≤ 75 mA at 24 V DC without output load |
| Initialization time | ≤ 2 s |
| Protection class | III |
| Connection type | Round connector M12 x 1, 5-pin |
| Length of cable | 3.3 m |
| Output signal | 1 x PNP + 1 x PNP/NPN + 4 mA ... 20 mA / 0 V ... 10 V |
| Output load | 4 mA ... 20 mA < 500 Ohm at U _v > 13,5 V, 4 mA ... 20 mA < 400 Ohm at U _v > 12 V, 0 V ... 10 V > 750 Ohm at U _v 14 ≥ V |
| Hysteresis | Min. 2 mm, free adjustable |
| Output current | < 100 mA |
| Inductive load | < 1 H |
| Capacitive load | < 100 nF |
| Enclosure rating | IP67 / 69: EN 60529 |
| Temperature drift | < 0.1 mm/K |
| Lower signal level | 3.8 mA ... 4 mA, 0 V |
| Upper signal level | 20 mA ... 20.5 mA, 10.5 V |
| EMC | EN 61326-2-3, 2014/30/EU |

¹⁾ All connections are polarity protected. All outputs are overload and short-circuit protected.

Mechanics

| | |
|-------------------------------|--|
| Wetted parts | 316L (Ra ≤ 0,8 μm), PEEK |
| Process connection | ¾" NPT |
| Housing material | 303 |
| Housing design | With viewing window made from PMMA (acrylic glass) |
| Max. probe load | ≤ 6 Nm |
| Material coaxial cable | FEP |
| Length coaxial cable | 3.3 m |

Ambient data

| | |
|--|------------------------|
| Ambient operating temperature | -20 °C ... +60 °C |
| Ambient temperature, storage | -40 °C ... +80 °C |
| Ambient temperature coaxial cable | -20 °C ... +60 °C |
| Outdoor use | Only with weather hood |

Classifications

| | |
|---------------------|----------|
| ECLASS 5.0 | 27200513 |
| ECLASS 5.1.4 | 27200513 |
| ECLASS 6.0 | 27200513 |
| ECLASS 6.2 | 27200513 |
| ECLASS 7.0 | 27200513 |
| ECLASS 8.0 | 27200513 |
| ECLASS 8.1 | 27200513 |

| | |
|-----------------------|----------|
| ECLASS 9.0 | 27200513 |
| ECLASS 10.0 | 27200513 |
| ECLASS 11.0 | 27200513 |
| ECLASS 12.0 | 27200513 |
| ETIM 5.0 | EC001447 |
| ETIM 6.0 | EC001447 |
| ETIM 7.0 | EC001447 |
| ETIM 8.0 | EC001447 |
| UNSPSC 16.0901 | 41113710 |

Type code

Type code

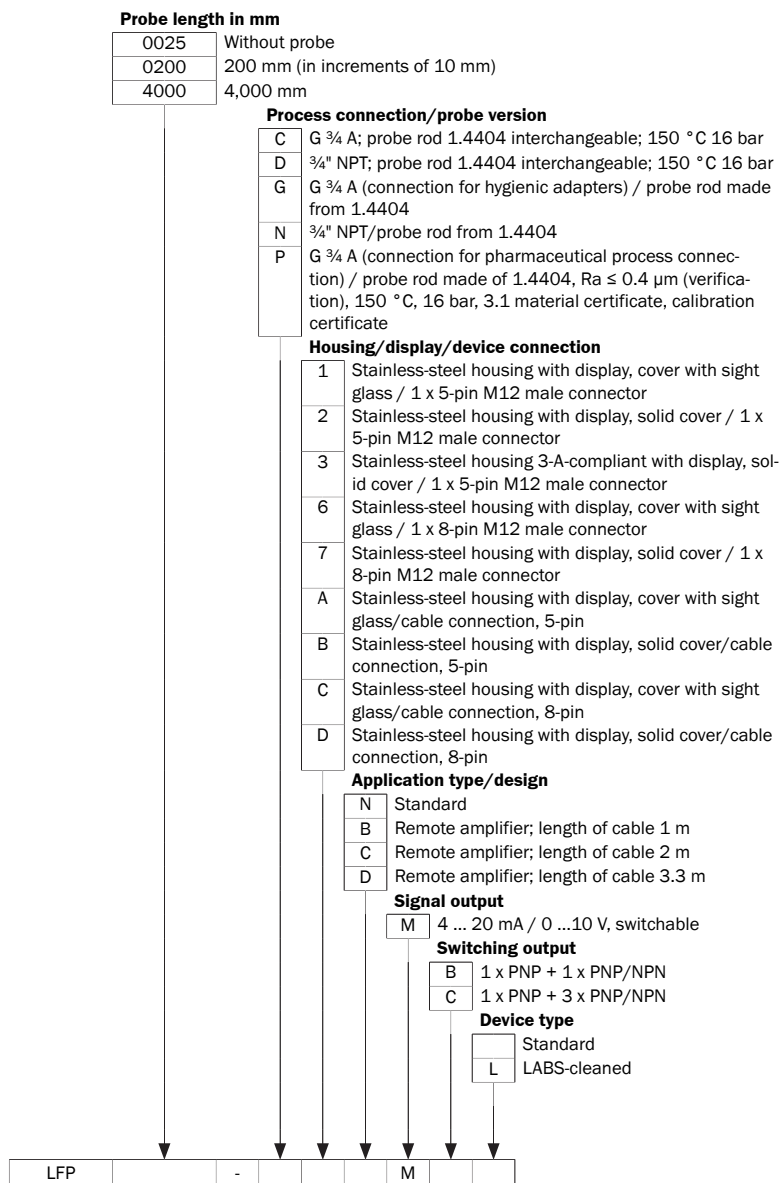

Not all variants of the type code can be combined!

Dependence between length of coaxial cable and probe length

| Length of coaxial cable (mm) | Max. probe length (mm) - foam mode deactivated | Max. probe length (mm) - foam mode active |
|------------------------------|--|---|
| 1000 | 4,000 | 2000 |
| 2000 | 3,000 | 1500 |
| 3300 | 1,000 | 500 |

Dimensional drawing (Dimensions in mm (inch))

Remote amplifier

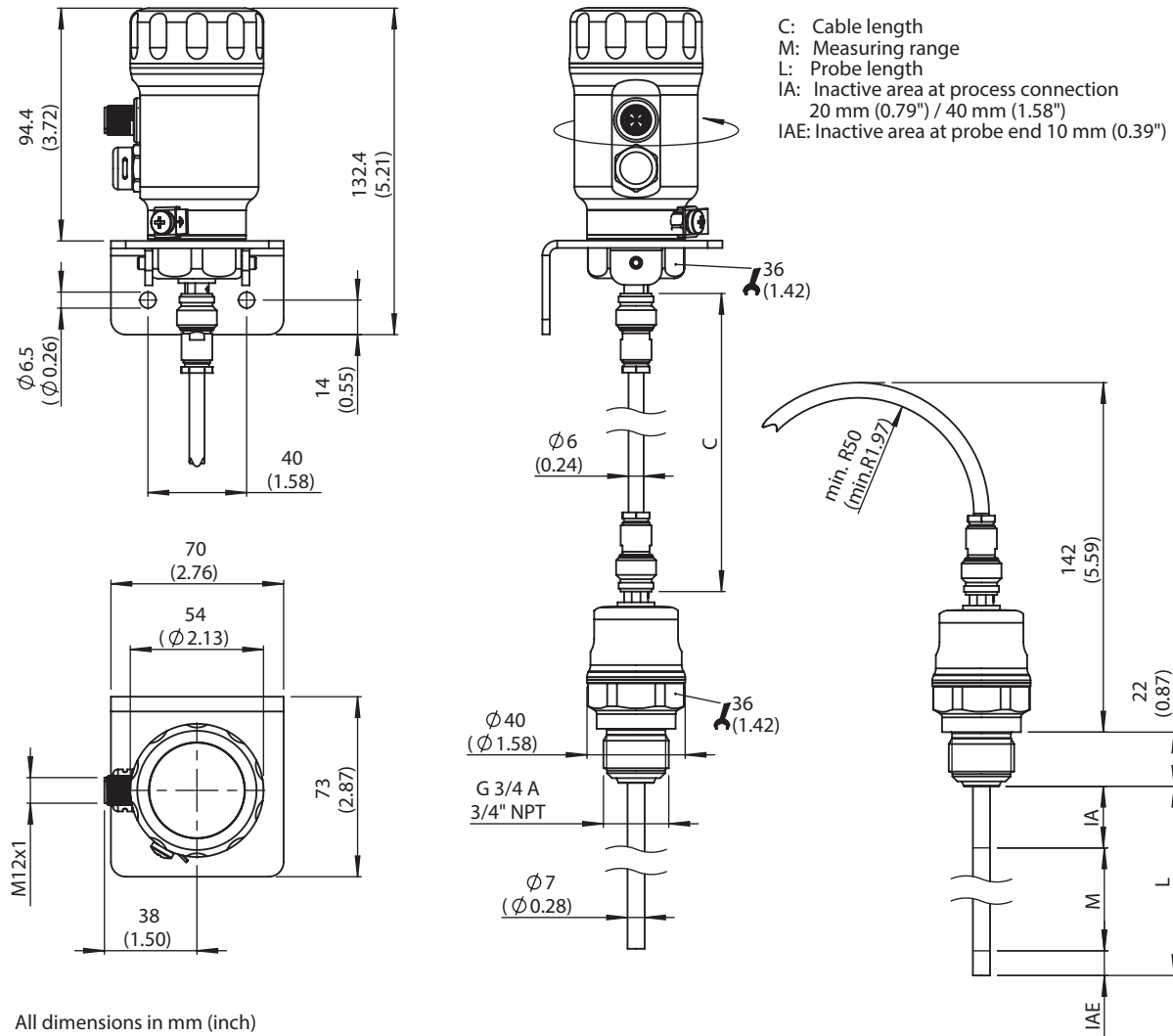

All dimensions in mm (inch)

Connection type







5-pole M12 Connector







- ① L⁺: Supply voltage, brown
- ② Q_A: Analog current-/voltage output, white
- ③ M: Ground, reference ground for current-/voltage output, blue
- ④ C/Q₁: Switching output 1, PNP/IO-Link-communication, black
- ⑤ Q₂: Switching output 2, PNP/NPN, grey

Recommended accessories

Other models and accessories → www.sick.com/LFP_Inox

| | Brief description | Type | Part no. |
|---|---|-------------------------|----------|
| Hardware | | | |
|  | Weather protection cover for LFP Inox, material: 304 | APR-WP-LFPO01-0001 | 2069530 |
| Spare parts | | | |
|  | Spare coaxial cable for LFP Inox, remote amplifier, length 3.3 m | CBL-CX-003300-LFPI | 2077797 |
|  | Cover closed, material 1.4305 | Cover closed | 2067269 |
|  | Cover for LFP Inox with inspection window, material 1.4305 and PMMA | Cover with front screen | 2067267 |
| Flanges | | | |
|  | Hygienic process connection adapter, Tri-Clamp 1" and 1 1/2", including acceptance test certificate 3.1; Ra ≤ 0.4 µm, hygienic in accordance with EHEDG in combination with T-seals or Tri-Clamp seals from Combifit International B.V. | BEF-HA-TCLI10-LFP2 | 2126242 |
|  | Hygienic process connection adapter, Tri-Clamp 2"; including acceptance test certificate 3.1; Ra ≤ 0.4 µm, hygienic in accordance with EHEDG in combination with T-seals or Tri-Clamp seals from Combifit International B.V. | BEF-HA-TCLI20-LFP2 | 2126243 |
|  | Weld-in flange, hygienic, G 3/4" including acceptance test certificate 3.1, Ra ≤ 0.4 µm, Stainless steel 1.4404 | BEF-HA-SWFL54-LFP2 | 2122489 |

| | Brief description | Type | Part no. |
|---|---|-----------------|----------|
| Plug connectors and cables | | | |
|  | <ul style="list-style-type: none"> • Connection type head A: Female connector, M12, 5-pin, straight • Connection type head B: Flying leads • Signal type: Sensor/actuator cable • Cable: 2 m, 5-wire, PVC • Description: Sensor/actuator cable, unshielded • Connection systems: Flying leads • Note: This product is generally resistant to chemical cleaning agents (see ECOLAB). Please do not use cleaning agents of any other Kind., Not resistant against lactic acid & hydrogen peroxide (H2O2) • Application: Hygienic and washdown zones | DOL-1205-G02MNI | 6052625 |
|  | <ul style="list-style-type: none"> • Connection type head A: Female connector, M12, 5-pin, straight • Connection type head B: Flying leads • Signal type: Sensor/actuator cable • Cable: 2 m, 5-wire, PP • Description: Sensor/actuator cable, unshielded • Connection systems: Flying leads • Note: This product is generally resistant to chemical cleaning agents (see ECOLAB) and other chemical compounds such as H2O2 and CH2O2. Before permanent installation is carried out, the material's resistance to the cleaning agent being used must be checked., Resistant against lactic acid & hydrogen peroxide (H2O2) • Application: Hygienic and washdown zones, Drag chain operation | DOL-1205-G02MRN | 6058494 |
|  | <ul style="list-style-type: none"> • Connection type head A: Female connector, M12, 5-pin, straight • Connection type head B: Flying leads • Signal type: Sensor/actuator cable • Cable: 5 m, 5-wire, PVC • Description: Sensor/actuator cable, unshielded • Connection systems: Flying leads • Note: This product is generally resistant to chemical cleaning agents (see ECOLAB). Please do not use cleaning agents of any other Kind., Not resistant against lactic acid & hydrogen peroxide (H2O2) • Application: Hygienic and washdown zones | DOL-1205-G05MNI | 6052626 |
|  | <ul style="list-style-type: none"> • Connection type head A: Female connector, M12, 5-pin, straight • Connection type head B: Flying leads • Signal type: Sensor/actuator cable • Cable: 5 m, 5-wire, PP • Description: Sensor/actuator cable, unshielded • Connection systems: Flying leads • Note: This product is generally resistant to chemical cleaning agents (see ECOLAB) and other chemical compounds such as H2O2 and CH2O2. Before permanent installation is carried out, the material's resistance to the cleaning agent being used must be checked., Resistant against lactic acid & hydrogen peroxide (H2O2) • Application: Hygienic and washdown zones, Drag chain operation | DOL-1205-G05MRN | 6058495 |
|  | <ul style="list-style-type: none"> • Connection type head A: Female connector, M12, 5-pin, straight • Connection type head B: Flying leads • Signal type: Sensor/actuator cable • Cable: 10 m, 5-wire, PVC • Description: Sensor/actuator cable, unshielded • Connection systems: Flying leads • Note: This product is generally resistant to chemical cleaning agents (see ECOLAB). Please do not use cleaning agents of any other Kind., Not resistant against lactic acid & hydrogen peroxide (H2O2) • Application: Hygienic and washdown zones | DOL-1205-G10MNI | 6052627 |

| | Brief description | Type | Part no. |
|---|--|--------------------|----------|
|  | <ul style="list-style-type: none"> • Connection type head A: Female connector, M12, 5-pin, straight • Connection type head B: Flying leads • Signal type: Sensor/actuator cable • Cable: 10 m, 5-wire, PP • Description: Sensor/actuator cable, unshielded • Connection systems: Flying leads • Note: This product is generally resistant to chemical cleaning agents (see ECOLAB) and other chemical compounds such as H2O2 and CH2O2. Before permanent installation is carried out, the material's resistance to the cleaning agent being used must be checked., Resistant against lactic acid & hydrogen peroxide (H2O2) • Application: Hygienic and washdown zones, Drag chain operation | DOL-1205-G10MRN | 6058496 |
|  | <ul style="list-style-type: none"> • Connection type head A: Female connector, M12, 5-pin, straight • Connection type head B: Flying leads • Signal type: Sensor/actuator cable • Cable: 25 m, 5-wire, PVC • Description: Sensor/actuator cable, unshielded • Connection systems: Flying leads • Note: This product is generally resistant to chemical cleaning agents (see ECOLAB). Please do not use cleaning agents of any other Kind., Not resistant against lactic acid & hydrogen peroxide (H2O2) • Application: Hygienic and washdown zones | DOL-1205-G25MNI | 6052628 |
|  | <ul style="list-style-type: none"> • Connection type head A: Female connector, M12, 5-pin, straight • Connection type head B: Flying leads • Signal type: Sensor/actuator cable • Cable: 25 m, 5-wire, PP • Description: Sensor/actuator cable, unshielded • Connection systems: Flying leads • Note: This product is generally resistant to chemical cleaning agents (see ECOLAB) and other chemical compounds such as H2O2 and CH2O2. Before permanent installation is carried out, the material's resistance to the cleaning agent being used must be checked., Resistant against lactic acid & hydrogen peroxide (H2O2) • Application: Hygienic and washdown zones, Drag chain operation | DOL-1205-G25MRN | 6058497 |
| Terminal and alignment brackets | | | |
|  | 1 piece, Centering for bypass- and immersion tube installation with diameter 40 mm ... 100 mm, PTFE | BEF-FL-BYRD40-LFP1 | 2059612 |

Recommended services

Additional services → www.sick.com/LFP_Inox

| | Type | Part no. |
|--|------------------------|------------|
| Function Block Factory | | |
| <ul style="list-style-type: none"> • Description: The Function Block Factory supports common programmable logic controllers (PLCs) from various manufacturers, such as Siemens, Beckhoff, Rockwell Automation and B&R. More information on the FBF can be found here. • Note: You can configure your function block at Function Block Factory. As a login please use your SICK ID. | Function Block Factory | On request |

SICK AT A GLANCE

SICK is one of the leading manufacturers of intelligent sensors and sensor solutions for industrial applications. A unique range of products and services creates the perfect basis for controlling processes securely and efficiently, protecting individuals from accidents and preventing damage to the environment.

We have extensive experience in a wide range of industries and understand their processes and requirements. With intelligent sensors, we can deliver exactly what our customers need. In application centers in Europe, Asia and North America, system solutions are tested and optimized in accordance with customer specifications. All this makes us a reliable supplier and development partner.

Comprehensive services complete our offering: SICK LifeTime Services provide support throughout the machine life cycle and ensure safety and productivity.

For us, that is “Sensor Intelligence.”

WORLDWIDE PRESENCE:

Contacts and other locations –www.sick.com