



WE026P-2416R500A00ZLLZZZZZZZZ1

L26

SAFETY SINGLE-BEAM SENSORS

SICK
Sensor Intelligence.



Ordering information

Scanning range	Type of light	System part	Type	Part no.
50 m	Red light, visible	Receiver	WEO26P-2416R500A00ZLLZZZZZZZZ1	2113109

Other models and accessories → www.sick.com/L26



Detailed technical data

Features

Smart Sensor	Diagnosis Efficient communication Smart Task
Type of light	Red light, visible
Scanning range	50 m
Number of beams	1
Detection capability	30 mm ¹⁾
Response time	0.5 ms
Response time	0.5 ms + Test device response time
Cascading	Cascading allows up to 4 single-beam photoelectric safety switches to be connected in series. You can find response times and connection diagrams for cascading in the operating instructions.

¹⁾ A test rod with a diameter of at least 30 mm is required for thorough check. Suitable test rods are available as accessories from SICK.

Safety-related parameters

Type	Type 2 (IEC 61496-1) ¹⁾
Safety integrity level	SIL 1 (IEC 61508) ¹⁾
Category	Category 2 (EN ISO 13849) ¹⁾
Test rate (external test)	100 /s (EN ISO 13849)
Maximum demand rate	≤ 60 min ⁻¹ (EN ISO 13849) ²⁾
Performance level	PL c (EN ISO 13849) ¹⁾

¹⁾ Only in combination with an appropriate test device, e.g., Flexi Classic or Flexi Soft.

²⁾ Between two requirements on a safety-related response of the device, at least 100 external tests must be carried out.

PFH_D (mean probability of a dangerous failure per hour)	1.0 x 10 ⁻⁶ (EN ISO 13849) ¹⁾
T_M (mission time)	20 years (EN ISO 13849)

¹⁾ Only in combination with an appropriate test device, e.g., Flexi Classic or Flexi Soft.

²⁾ Between two requirements on a safety-related response of the device, at least 100 external tests must be carried out.

Interfaces

Connection type	Male connector M12, 4-pin, connector 270° rotatable
Configuration method	Via IO-Link
Display elements	LEDs
Alignment aid	Alignment quality via diagnostic LEDs Easy and quick sensor alignment using BluePilot
Application diagnostic output (ADO)	✓
IO-Link	✓
Data exchange via IO-Link	Device information Quality of reception
Configuration via IO-Link	Switching output Application diagnostic output (ADO)
IO-Link master	SiLink2 Master IOLA2US-01101
Configuration software	SOPAS ET

Electrical data

Protection class	III (IEC 61140)
Supply voltage V_S	24 V DC (19.2 V DC ... 28.8 V DC)
Residual ripple	≤ 5 V
Power consumption	≤ 30 mA
Switching outputs	Push-pull ¹⁾
Current loading	≤ 100 mA

¹⁾ Switching output for controlling the downstream test device, no OSSD according to IEC 61496-1. Output short-circuit protected.

Mechanical data

Design	Rectangular
Dimensions (W x H x D)	26.4 mm x 48.1 mm x 82.2 mm
Housing material	VISTAL®

Ambient data

Enclosure rating	IP66 (IEC 60529) IP67 (IEC 60529) IP69K (ISO 20653)
Ambient operating temperature	-40 °C ... +60 °C
Storage temperature	-40 °C ... +75 °C
Air humidity	15 % ... 95 %, Non-condensing
Vibration resistance	5 g, 10 Hz ... 55 Hz (IEC 60068-2-6)
Shock resistance	10 g, 16 ms (IEC 60068-2-29)

Other information

Type of light	Red light, visible
----------------------	--------------------

Classifications

ECLASS 5.0	27272701
ECLASS 5.1.4	27272701
ECLASS 6.0	27272701
ECLASS 6.2	27272701
ECLASS 7.0	27272701
ECLASS 8.0	27272701
ECLASS 8.1	27272701
ECLASS 9.0	27272701
ECLASS 10.0	27272701
ECLASS 11.0	27272701
ECLASS 12.0	27272701
ETIM 5.0	EC001831
ETIM 6.0	EC001831
ETIM 7.0	EC001831
ETIM 8.0	EC001831
UNSPSC 16.0901	46171620

Dimensional drawing (Dimensions in mm (inch))

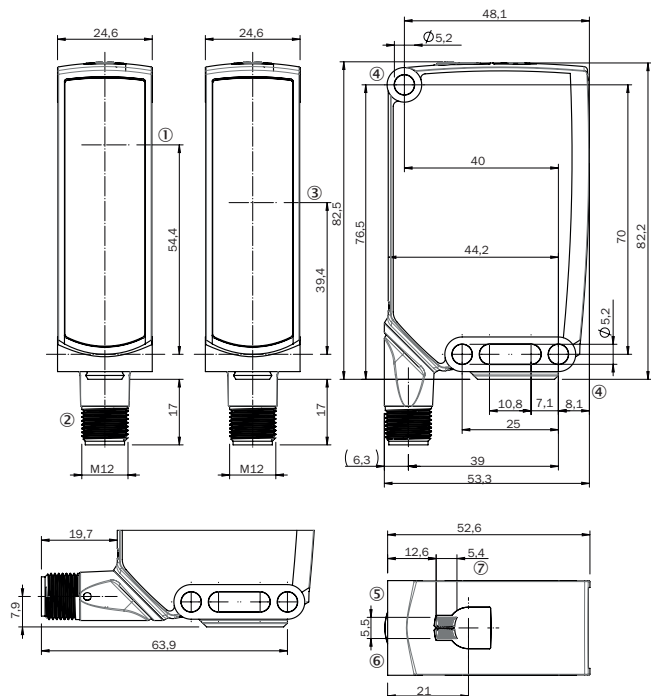

L26











- ① Center of optical axis, sender
- ② Connection
- ③ Center of optical axis, receiver
- ④ Mounting holes
- ⑤ Green operating LED: Supply voltage active
- ⑥ Yellow status LED: Light receiver indication
- ⑦ Alignment aid (BluePilot): Blue alignment quality LEDs

Recommended accessories

Other models and accessories → www.sick.com/L26

	Brief description	Type	Part no.
Connection modules			
	IO-Link V1.1 Class A port, USB2.0 port, optional external power supply 24V / 1A	IOLA2US-01101 (SiLink2 Master)	1061790
Universal bar clamp systems			
	Plate A for universal clamp bracket, steel, zinc coated, Universal clamp (2022726), mounting hardware	BEF-KHS-A01	2022458
	Plate N04 for universal clamp, steel, Zinc plated steel (sheet), Zinc die cast (clamping bracket), Universal clamp (5322626), mounting hardware	BEF-KHS-N04	2051610

	Brief description	Type	Part no.
Device protection (mechanical)			
	Protective housing for W26, W27-3 and mounting rods with diameter 12 mm ... 20 mm, Zinc plated steel (protective housing), Zinc die cast (clamping bracket), Universal clamp BEF-KHS-KH1 (2022726), mounting hardware	BEF-SG-W27	2039601
Mounting brackets and plates			
	Mounting bracket with articulated arm for W11-2, W27, Dx50, steel, zinc coated, mounting hardware included	BEF-WN-MULTI	2064469
	Mounting bracket with articulated arm, steel, zinc coated, mounting hardware included	BEF-WN-MULTI2	2093945
	Mounting bracket, steel, zinc coated, mounting hardware included	BEF-WN-W23	2019085
	Mounting bracket with hinged arm, steel, zinc coated, mounting hardware included	BEF-WN-W27	2009122
Plug connectors and cables			
	<ul style="list-style-type: none"> • Connection type head A: Female connector, M12, 4-pin, straight, A-coded • Connection type head B: Flying leads • Signal type: Sensor/actuator cable • Cable: 5 m, 4-wire, PVC • Description: Sensor/actuator cable, unshielded • Application: Zones with chemicals 	YF2A14-050VB3XLEAX	2096235
Sensor Integration Gateway			
	<ul style="list-style-type: none"> • Further functions: Web server integrated, USB connection for easy configuration of the SIG200 Sensor Integration Gateway with SOPAS ET, the engineering tool from SICK, logic editor is available for easy configuration of logic functions • Connection CONFIG: 1 x M8, 4-pin female connector, USB 2.0 (USB-A) • Logic editor: yes • Communication interface: IO-Link, USB, Ethernet, PROFINET, REST API • Product category: IO-Link Master 	SIG200-0A0412200	1089794
	<ul style="list-style-type: none"> • Further functions: Web server integrated, USB connection for easy configuration of the SIG200 Sensor Integration Gateway with SOPAS ET, the engineering tool from SICK, logic editor is available for easy configuration of logic functions • Connection CONFIG: 1 x M8, 4-pin female connector, USB 2.0 (USB-A) • Logic editor: yes • Communication interface: IO-Link, USB, Ethernet, REST API • Product category: IO-Link Master 	SIG200-0A0G12200	1102605

SICK AT A GLANCE

SICK is one of the leading manufacturers of intelligent sensors and sensor solutions for industrial applications. A unique range of products and services creates the perfect basis for controlling processes securely and efficiently, protecting individuals from accidents and preventing damage to the environment.

We have extensive experience in a wide range of industries and understand their processes and requirements. With intelligent sensors, we can deliver exactly what our customers need. In application centers in Europe, Asia and North America, system solutions are tested and optimized in accordance with customer specifications. All this makes us a reliable supplier and development partner.

Comprehensive services complete our offering: SICK LifeTime Services provide support throughout the machine life cycle and ensure safety and productivity.

For us, that is “Sensor Intelligence.”

WORLDWIDE PRESENCE:

Contacts and other locations –www.sick.com