

# EEM37-2KF0B017A

EES/EEM37

MOTOR FEEDBACK SYSTEMS ROTARY HIPERFACE DSL®

**SICK**  
Sensor Intelligence.

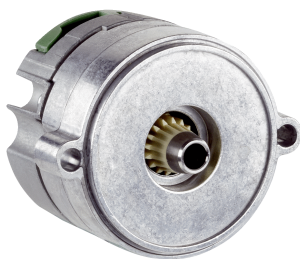

### Ordering information

Type	Part no.
EEM37-2KFOB017A	1086280

Other models and accessories → [www.sick.com/EES\\_EEM37](http://www.sick.com/EES_EEM37)

Illustration may differ



### Detailed technical data

#### Safety-related parameters

<b>Safety integrity level</b>	SIL 2 (IEC 61508), SILCL3 (EN 62061) <sup>1)</sup>
<b>Category</b>	3 (EN ISO 13849)
<b>Systematic suitability</b>	SC 3 (IEC61508)
<b>Test rate</b>	24 h
<b>Maximum demand rate</b>	216 µs
<b>Performance level</b>	PL d (EN ISO 13849)
<b>Basis for safety function</b>	Safe singleturn absolute position
<b>Safety-related resolution</b>	Channel 1 = 15 or 17 bit, channel 2 = 15 or 17 bit
<b>PFH<sub>D</sub>: Probability of dangerous failure per hour</b>	26 x 10 <sup>-9 2)</sup>
<b>T<sub>M</sub> (mission time)</b>	20 years
<b>Safety-related accuracy</b>	1° <sup>3)</sup>

<sup>1)</sup> For more detailed information on the exact configuration of your machine/unit, please consult your relevant SICK branch office.

<sup>2)</sup> The values displayed apply to a diagnostic degree of coverage of 90%, which must be achieved by the external drive system.

<sup>3)</sup> The safety-related accuracy indicates the maximum positioning error limit with which the safety functions can be supported.

#### Performance

<b>Position</b>	
Resolution per revolution	17 bit
System accuracy	± 240 ", ± 160 ", nominal position, 25 °C, filter setting 21 kHz, Nominal position, 25 °C, filter setting 1 kHz <sup>1)</sup>
Signal noise (σ)	± 20 " (nominal position, 25 °C, filter setting 21 kHz)
Number of the absolute ascertainable revolutions	4,096
Available memory area	8,192 Byte
Measurement step per revolution	131,072

<sup>1)</sup> See diagram for error limits (default filter setting: 21 kHz).

## Interfaces

<b>Code sequence</b>	Increasing, when turning the shaft For clockwise rotation, looking in direction "A" (see dimensional drawing)
<b>Communication interface</b>	HIPERFACE DSL®
<b>Initialization time</b>	Max. 500 ms <sup>1)</sup>
<b>Measurement external temperature resistance</b>	32-bit value, without prefix (1 Ω) 0 ... 209.600 Ω <sup>2)</sup>

<sup>1)</sup> From reaching a permitted operating voltage.

<sup>2)</sup> Without sensor tolerance; at -17 °C ... +167 °C: NTC +2K (103 GT); PTC+3K (KTY84/130/PT1000).

## Electrical data

<b>Connection type</b>	Male connector, 4-pin
<b>Supply voltage</b>	7 V ... 12 V
<b>Warm-up time voltage ramp</b>	Max. 180 ms <sup>1)</sup>
<b>Current consumption</b>	≤ 150 mA <sup>2)</sup>

<sup>1)</sup> Duration of the voltage ramp between 0 and 7.0 V, see diagram "Current consumption" in the diagram section.

<sup>2)</sup> Current rating applies when using interface circuit suggestions as shown in HIPERFACE DSL® manual (8017595).

## Mechanical data

<b>Shaft version</b>	Tapered shaft
<b>Dimensions</b>	See dimensional drawing
<b>Centering collar</b>	Reduced 0.7 mm
<b>Weight</b>	≤ 0.1 kg
<b>Moment of inertia of the rotor</b>	1 gcm <sup>2</sup>
<b>Operating speed</b>	≤ 12,000 min <sup>-1</sup>
<b>Angular acceleration</b>	≤ 500,000 rad/s <sup>2</sup>
<b>Permissible radial shaft movement</b>	± 0.15 mm
<b>Permissible axial shaft movement</b>	± 0.5 mm

## Ambient data

<b>Operating temperature range</b>	-40 °C ... +115 °C <sup>1)</sup>
<b>Storage temperature range</b>	-40 °C ... +120 °C, without package
<b>Relative humidity/condensation</b>	85 %, Condensation not permitted
<b>Resistance to shocks</b>	100 g, 6 ms (according to EN 60068-2-27)
<b>Frequency range of resistance to vibrations</b>	50 g, 10 Hz ... 2,000 Hz (EN 60068-2-6)
<b>EMC</b>	According to EN 61000-6-2: 2016, EN 61000-6-4: 2006, IEC 6100-6-7: 2014 <sup>2)</sup>
<b>Enclosure rating</b>	IP30, When cover is closed and mating connector is attached (IEC 60529-1) <sup>3)</sup>

<sup>1)</sup> For typical values for self-heating, see diagram "Electrical self-heating" in the diagram section. see section "Mounting" in the operating instructions (8021414/8021265).

<sup>2)</sup> According to the listed standards, EMC is guaranteed if the motor feedback system with mating connector inserted is connected to the central grounding point of the motor controller via a cable shield. If other shielding concepts are used, users must perform their own tests. Class A device.

<sup>3)</sup> When using the strands (2079920).

## Classifications

<b>ECLASS 5.0</b>	27270590
-------------------	----------

<b>ECLASS 5.1.4</b>	27270590
<b>ECLASS 6.0</b>	27270590
<b>ECLASS 6.2</b>	27270590
<b>ECLASS 7.0</b>	27270590
<b>ECLASS 8.0</b>	27270590
<b>ECLASS 8.1</b>	27270590
<b>ECLASS 9.0</b>	27270590
<b>ECLASS 10.0</b>	27273805
<b>ECLASS 11.0</b>	27273901
<b>ECLASS 12.0</b>	27273901
<b>ETIM 5.0</b>	EC001486
<b>ETIM 6.0</b>	EC001486
<b>ETIM 7.0</b>	EC001486
<b>ETIM 8.0</b>	EC001486
<b>UNSPSC 16.0901</b>	41112113

### Dimensional drawing (Dimensions in mm (inch))

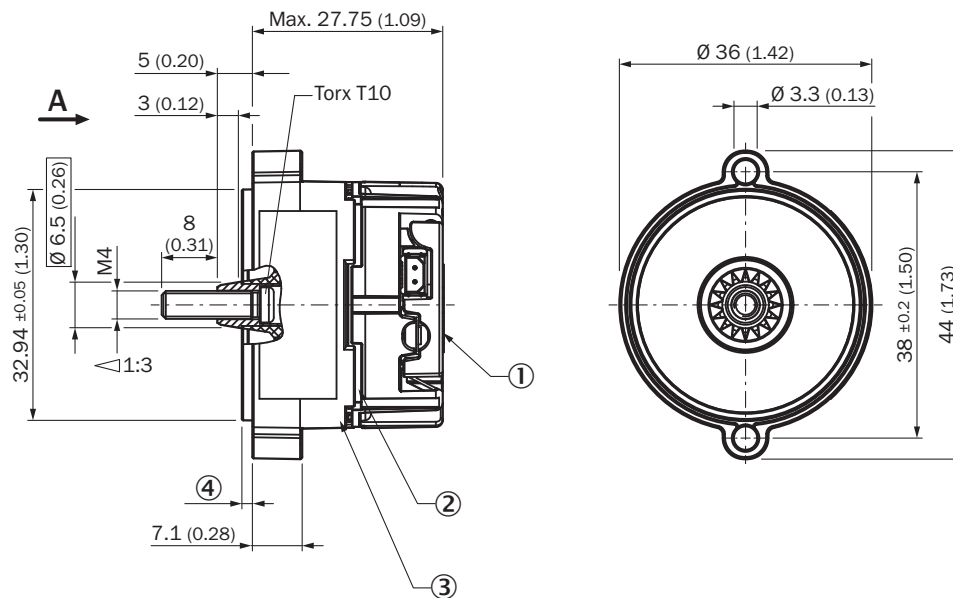

Screw M4 not included (see under accessories)

- ① Measuring point for vibrations
- ② Design-related gap
- ③ Measuring point for operating temperature
- ④ Centering collar: Standard 1.5 mm; reduced 0.7 mm



PIN	Signal	Explanation
Recommended mating connector: Harwin M80-8990205		

**Diagrams**

Power consumption

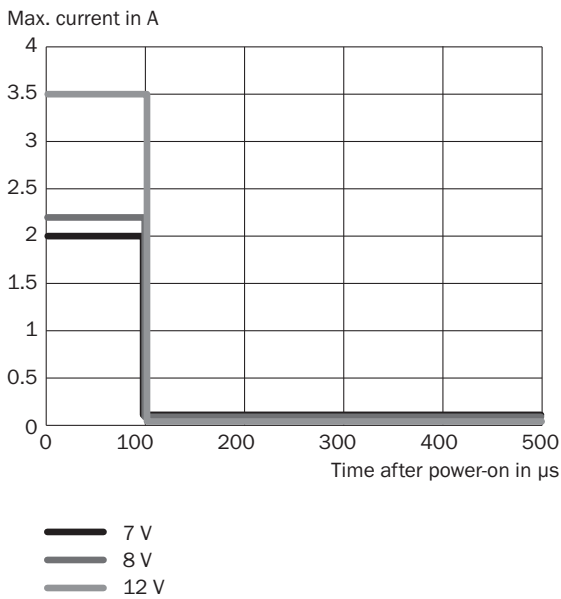

This diagram shows the switch-on current  
 Latency vs. filter frequency

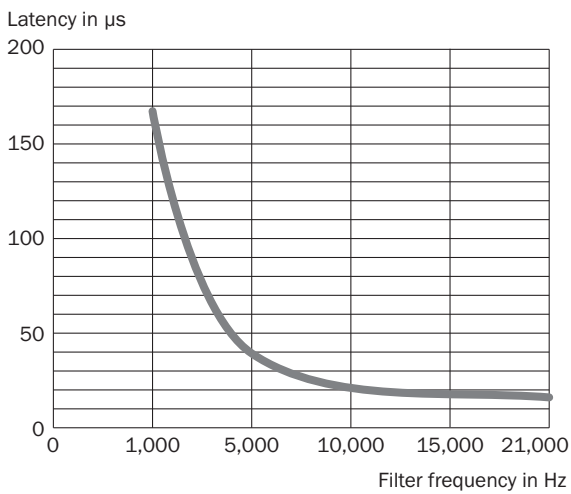

Adjustable filter frequencies 21 kHz, 15 kHz, 10 kHz, 5 kHz and 1 kHz - Default setting 21 kHz

Error limits

Typ. effect of temperature on accuracy, normed

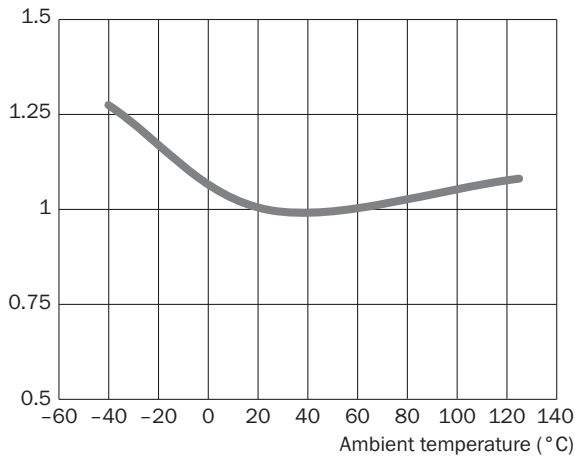

Error limits

Typ. effect of axial position on accuracy, normed

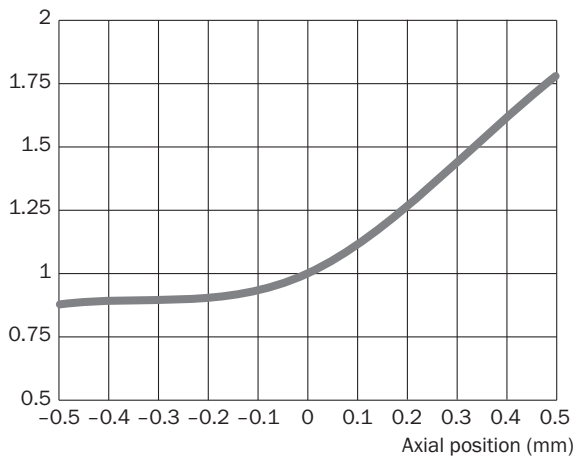

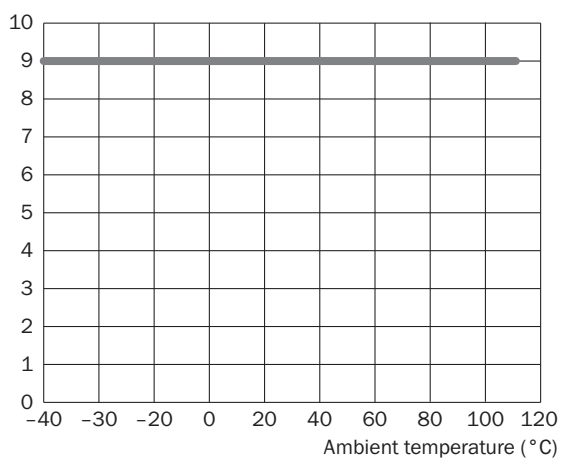

Electrical self-heating

Typ. electrical self-heating, kelvin (K)



### Recommended accessories

Other models and accessories → [www.sick.com/EES\\_EEM37](http://www.sick.com/EES_EEM37)

	Brief description	Type	Part no.
Nuts and screws			
	100 pieces, Screws with Precote 85-8 coating; M4*14	BEF-MK-S03	2077358
	10 pieces, Screws with Precote 85-8 coating; M4*14	BEF-MK-S07	2088239
	500 pieces, Screws with Precote 85-8 coating; M4*14	BEF-MK-S08	2088240
Other mounting accessories			
	BEF-MW-PL	BEF-MW-PL	2084768
Plug connectors and cables			
	<ul style="list-style-type: none"> <li>• <b>Connection type head A:</b> Female connector, stranded wire, 4-pin, straight</li> <li>• <b>Connection type head B:</b> Flying leads</li> <li>• <b>Signal type:</b> HIPERFACE DSL®</li> <li>• <b>Cable:</b> 0.2 m, 2-wire</li> <li>• <b>Description:</b> HIPERFACE DSL®, unshielded</li> </ul>	DOL-0B02-G0M2XC2	2079920



## SICK AT A GLANCE

SICK is one of the leading manufacturers of intelligent sensors and sensor solutions for industrial applications. A unique range of products and services creates the perfect basis for controlling processes securely and efficiently, protecting individuals from accidents and preventing damage to the environment.

We have extensive experience in a wide range of industries and understand their processes and requirements. With intelligent sensors, we can deliver exactly what our customers need. In application centers in Europe, Asia and North America, system solutions are tested and optimized in accordance with customer specifications. All this makes us a reliable supplier and development partner.

Comprehensive services complete our offering: SICK LifeTime Services provide support throughout the machine life cycle and ensure safety and productivity.

For us, that is “Sensor Intelligence.”

## WORLDWIDE PRESENCE:

Contacts and other locations –[www.sick.com](http://www.sick.com)