

Part number

TAPH 10.32

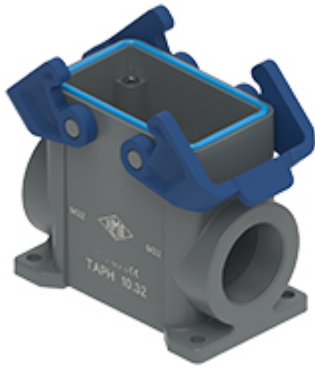

Surface mounting housing, T-TYPE /H series, with 2 levers, M32 cable entry, size "57.27"

Product description

Product type	Surface mounting housing
Series	T-TYPE /H
Closing type	With 2 levers
Size	Size "57.27"
Cable entry	M32

Technical data

IP degree of protection	IP66/IP69
--------------------------------	-----------

Further technical details

Weight	156,00 g
Operating temperature range (min, max)	-40°C ... +70°C

Material properties

Main material	Polypropylene (PP)
Other materials	Lever: polypropylene (PP) Gasket: HNBR
Colour	RAL 7012 grey, RAL 5005 blue
RoHs conformity	Compliant
China RoHs - EFUP	E
REACH SVHC substances	No

General ordering information

EAN13 code	8015747209939
eCl@ss 8.1	27440202
ETIM 7.0	EC000437

Packaging Information

Packaging length	310,00 mm
Packaging height	220,00 mm
Packaging width	240,00 mm
Packaging weight	3,40 kg
Packaging volume	16,37 dm ³
Packaging description	Carton box
Packaging quantity	20 Pcs
Packaging EAN code	8015747210072
Sub-packaging weight	0,85 kg
Sub-packaging description	Plastic packaging
Sub-packaging quantity	5 Pcs
Sub-packaging EAN barcode	8015747210089

Part number

TAPH 10.32



Catalogue drawings

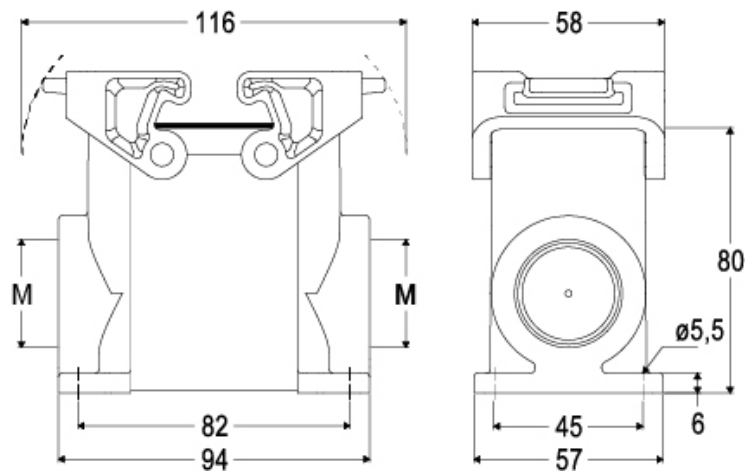

Notes

Dimensions shown in mm are not binding and may be changed without notice.
