



**IM18-05B-N-ZW0**

IMN

**INDUCTIVE PROXIMITY SENSORS**

**SICK**  
Sensor Intelligence.



Illustration may differ



## Ordering information

Type	Part no.
IM18-05B-N-ZW0	6021126

**Included in delivery:** BEF-MU-M18 (1)

Other models and accessories → [www.sick.com/IMN](http://www.sick.com/IMN)

## Detailed technical data

### Features

<b>Housing</b>	Cylindrical thread design
<b>Thread size</b>	M18 x 1
<b>Diameter</b>	Ø 18 mm
<b>Sensing range <math>S_n</math></b>	5 mm
<b>Safe sensing range <math>S_a</math></b>	4.05 mm
<b>Installation type</b>	Flush
<b>Switching frequency</b>	720 Hz
<b>Connection type</b>	Cable, 2-wire, 2 m
<b>Switching output</b>	NAMUR
<b>Output function</b>	NC
<b>Enclosure rating</b>	IP67 <sup>1)</sup>
<b>Special applications</b>	Explosive areas
<b>Items supplied</b>	Mounting nut, brass, nickel-plated (2x)

<sup>1)</sup> According to EN 60529.

### Mechanics/electronics

<b>Supply voltage</b>	7.5 V DC ... 25 V DC <sup>1)</sup>
<b>Hysteresis</b>	1 % ... 15 %
<b>Temperature drift (of <math>S_n</math>)</b>	± 10 %
<b>EMC</b>	According to EN 60947-5-6
<b>Current consumption, sensor is activated</b>	≤ 1 mA

<sup>1)</sup> When used outside the hazardous area.

<sup>2)</sup> For connection to a separately certified intrinsically safe circuit only.

<sup>3)</sup> 1 kΩ.

<b>Current consumption, sensor is not activated</b>	≥ 2.2 mA
<b>Cable material</b>	PVC
<b>Conductor size</b>	0.5 mm <sup>2</sup>
<b>Cable diameter</b>	Ø 5.4 mm
<b>Cable resistance</b>	50 Ω
<b>Shock and vibration resistance</b>	30 g, 11 ms / 10 ... 55 Hz, 1 mm
<b>Ambient operating temperature</b>	-20 °C ... +70 °C
<b>Housing material</b>	Brass, nickel-plated
<b>Sensing face material</b>	Plastic, PTB
<b>Housing length</b>	33 mm
<b>Thread length</b>	32 mm
<b>Tightening torque, max.</b>	35 Nm
<b>Weight</b>	+ 171 g
<b>Type approval certificate</b>	PTB 03 ATEX 2037
<b>Ex area category</b>	1G, 2G
<b>Input voltage U<sub>i</sub> max.</b>	15 V <sup>2)</sup>
<b>Input power P<sub>i</sub> max.</b>	120 mW <sup>2)</sup>
<b>Input current I<sub>i</sub> max.</b>	50 mA <sup>2)</sup>
<b>Internal capacitance C<sub>i</sub> max.</b>	145 nF <sup>2)</sup>
<b>Internal inductance L<sub>i</sub> max.</b>	45 µH <sup>2)</sup>
<b>Nominal voltage</b>	8.2 V DC <sup>3)</sup>
<b>Device labeling</b>	II 1G Ex ia IIC T6 Ga Ta -20 °C ... +70 °C, II 2 G Ex ia IIC T6 Gb Ta: -20 °C ... +70 °C

<sup>1)</sup> When used outside the hazardous area.

<sup>2)</sup> For connection to a separately certified intrinsically safe circuit only.

<sup>3)</sup> 1 kΩ.

### Safety-related parameters

<b>MTTF<sub>D</sub></b>	7,515 years
<b>DC<sub>avg</sub></b>	0%
<b>T<sub>M</sub> (mission time)</b>	20 years

### Reduction factors

<b>Note</b>	The values are reference values which may vary
<b>Stainless steel (V2A, 304)</b>	Approx. 0.7
<b>Aluminum (Al)</b>	Approx. 0.4
<b>Copper (Cu)</b>	Approx. 0.3
<b>Brass (Br)</b>	Approx. 0.5

### Installation note

<b>Remark</b>	Associated graphic see "Installation"
<b>B</b>	18 mm
<b>C</b>	18 mm

<b>D</b>	15 mm
<b>F</b>	40 mm

Classifications

<b>ECLASS 5.0</b>	27270101
<b>ECLASS 5.1.4</b>	27270101
<b>ECLASS 6.0</b>	27270101
<b>ECLASS 6.2</b>	27270101
<b>ECLASS 7.0</b>	27270101
<b>ECLASS 8.0</b>	27270101
<b>ECLASS 8.1</b>	27270101
<b>ECLASS 9.0</b>	27270101
<b>ECLASS 10.0</b>	27270101
<b>ECLASS 11.0</b>	27270101
<b>ECLASS 12.0</b>	27274001
<b>ETIM 5.0</b>	EC002714
<b>ETIM 6.0</b>	EC002714
<b>ETIM 7.0</b>	EC002714
<b>ETIM 8.0</b>	EC002714
<b>UNSPSC 16.0901</b>	39122230

Installation note

Flush installation

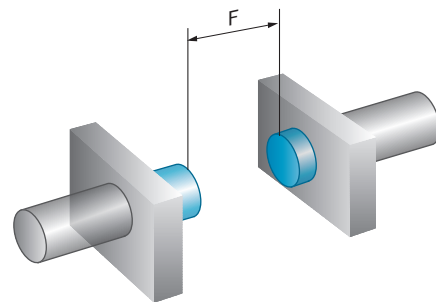
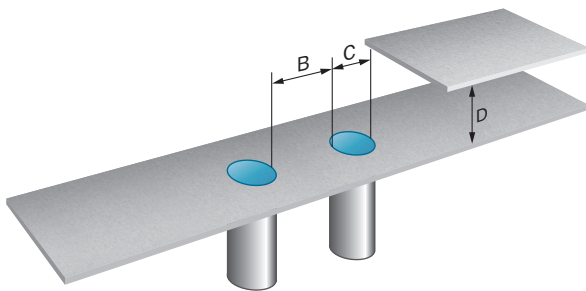

Connection type

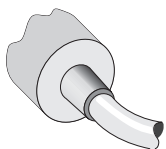

## Connection diagram

Cd-012



## Dimensional drawing (Dimensions in mm (inch))



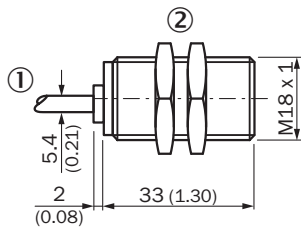

IM18 Namur, flush



- ① Connection
- ② Fastening nuts (2x); width across 24, metal

## Recommended accessories

Other models and accessories → [www.sick.com/IMN](http://www.sick.com/IMN)

	Brief description	Type	Part no.
<b>Power supply modules</b>			
	NAMUR isolating amplifier, Cable fault detection, Switching outputs: 2 NO relay (1 per channel), Supply voltage: 24 V ... 230 V, Voltage type: AC/DC	EN2-2EX1	6041096
<b>Universal bar clamp systems</b>			
	Plate N06 for universal clamp bracket, M18, Zinc plated steel (sheet), Zinc die cast (clamping bracket), Universal clamp (5322626), mounting hardware	BEF-KHS-N06	2051612
<b>Mounting brackets and plates</b>			
	Mounting plate for M18 sensors, steel, zinc coated, without mounting hardware	BEF-WG-M18	5321870
	Mounting bracket for M18 sensors, steel, zinc coated, without mounting hardware	BEF-WN-M18	5308446

## SICK AT A GLANCE

SICK is one of the leading manufacturers of intelligent sensors and sensor solutions for industrial applications. A unique range of products and services creates the perfect basis for controlling processes securely and efficiently, protecting individuals from accidents and preventing damage to the environment.

We have extensive experience in a wide range of industries and understand their processes and requirements. With intelligent sensors, we can deliver exactly what our customers need. In application centers in Europe, Asia and North America, system solutions are tested and optimized in accordance with customer specifications. All this makes us a reliable supplier and development partner.

Comprehensive services complete our offering: SICK LifeTime Services provide support throughout the machine life cycle and ensure safety and productivity.

For us, that is “Sensor Intelligence.”

## WORLDWIDE PRESENCE:

Contacts and other locations –[www.sick.com](http://www.sick.com)