



MLG10A-2390B10501

MLG-2

MEASURING AUTOMATION LIGHT GRIDS

SICK
Sensor Intelligence.



Illustration may differ



Ordering information

Type	Part no.
MLG10A-2390B10501	1214662

Other models and accessories → www.sick.com/MLG-2

Detailed technical data

Features

Device version	Pro - Advanced functionality
Sensor principle	Sender/receiver
Minimum detectable object (MDO)	10 mm, 14 mm ^{1) 2) 3)}
Beam separation	10 mm
Type of synchronization	Cable
Number of beams	240
Detection height	2,390 mm
Software features (default)	<ul style="list-style-type: none"> Q_{A1} Number of broken beams/NBB Q_{A2} Height measurement (last beam)/LBB Q₁ Presence detection Q2 / IN Teach input Teach Standard mode
Operating mode	<ul style="list-style-type: none"> Standard ✓ Transparent ✓ Dust- and sunlight-resistant ✓
Function	<ul style="list-style-type: none"> Cross beam ✓

¹⁾ MDO min. detectable object at high measurement accuracy.

²⁾ MDO min. detectable object for standard measurement accuracy.

³⁾ Depending on beam separation without cross beam setting.

Beam blanking	✓
High-speed scan	✓
High measurement accuracy	✓
Applications	
Switching output	Object recognition/object width Object recognition Height classification Hole detection/hole size Outside dimension/inside dimension Object position Hole position Zone definition
Data interface	Object detection Hole detection Object height measurement Measurement of external dimension Measurement of inside dimension Measurement of object position Measurement of hole position
Included with delivery	1 × sender 1 × receiver 4/6 × QuickFix brackets (6 × QuickFix brackets for monitoring heights above 2 m) 1 × Quick Start Guide

1) MDO min. detectable object at high measurement accuracy.

2) MDO min. detectable object for standard measurement accuracy.

3) Depending on beam separation without cross beam setting.

Mechanics/electronics

Light source	LED, Infrared light
Wave length	850 nm
Supply voltage V_s	DC 19.2 V ... 28.8 V ¹⁾
Power consumption sender	67 mA ²⁾
Power consumption receiver	168 mA ²⁾
Ripple	< 5 V _{pp}
Output current I_{max}	100 mA
Output load, capacitive	100 nF
Output load, Inductive	1 H
Initialization time	< 1 s
Switching output	Push-pull: PNP/NPN
Connection type	Male connector M12, 5-pin, 0.22 m Male connector M12, 8-pin, 0.27 m M12 female connector, 4-pin, D-coded, 0.19 m
Housing material	Aluminum
Indication	LED
Enclosure rating	IP65, IP67 ³⁾
Circuit protection	U _V connections, reverse polarity protected Output Q short-circuit protected

1) Without load.

2) , Without load with 24 V.

3) Operating in outdoor condition only with a external protection housing.

	Interference pulse suppression
Protection class	III
Weight	5.049 kg
Front screen	PMMA
Option	None
UL File No.	NRKH.E181493

¹⁾ Without load.

²⁾ , Without load with 24 V.

³⁾ Operating in outdoor condition only with a external protection housing.

Performance

Maximum range	7 m ¹⁾
Minimum range	≥ 0 m
Operating range	5 m
Response time	19.8 ms ²⁾

¹⁾ No reserve for environmental issue and deterioration of the diode.

²⁾ Without high speed.

Communication interface

IO-Link	✓, IO-Link V1.1
Data transmission rate	230,4 kbit/s (COM3)
Maximum cable length	20 m
Cycle time	2.3 ms
VendorID	26
DeviceID HEX	800068
DeviceID DEC	8388712
Process data length	32 Byte (TYPE_2_V) ¹⁾
Analog	✓, Current
Inputs/outputs	2 x analog + 2 x Q (IO-Link)
Analog output (current)	4 mA ... 20 mA
Analog output	Q _{A1} , Q _{A2}
Number	2
Type	Current output
Current	4 mA ... 20 mA
Digital output	Q ₁ , Q ₂
Number	2
Digital input	In ₁
Number	1

¹⁾ With an IO-Link master with V1.0, fall back to interleaved mode (consisting of TYPE_1_1 (ProcessData) and TYPE_1_2 (On-request Data)).

Ambient data

Shock resistance	Continuous shocks 10 g, 16 ms, 1000 shocks Single shocks 15 g, 11 ms 3 per axle
-------------------------	--

¹⁾ Outdoor mode.

²⁾ Light resistance indirect.

Vibration resistance	Sinusoidal oscillation 10-150 Hz 5 g
EMC	EN 60947-5-2
Ambient light immunity	Direct: 150,000 lx ¹⁾ Indirect: 200,000 lx ²⁾
Ambient operating temperature	-30 °C ... +55 °C
Ambient temperature, storage	-40 °C ... +70 °C

¹⁾ Outdoor mode.

²⁾ Light resistance indirect.

Smart Task

Smart Task name	Base logics
------------------------	-------------

Classifications

ECLASS 5.0	27270910
ECLASS 5.1.4	27270910
ECLASS 6.0	27270910
ECLASS 6.2	27270910
ECLASS 7.0	27270910
ECLASS 8.0	27270910
ECLASS 8.1	27270910
ECLASS 9.0	27270910
ECLASS 10.0	27270910
ECLASS 11.0	27270910
ECLASS 12.0	27270910
ETIM 5.0	EC002549
ETIM 6.0	EC002549
ETIM 7.0	EC002549
ETIM 8.0	EC002549
UNSPSC 16.0901	39121528

Dimensional drawing (Dimensions in mm (inch))

Dimensional drawing



	A ¹⁾	B ²⁾
Strahlabstand 2,5 mm	62,25	17,15
Strahlabstand 5 mm	63,3	16,1
Strahlabstand 10 mm	68,3	16,1
Strahlabstand 20 mm	68,3/78,3 ³⁾	16,1
Strahlabstand 25 mm	83,3	16,1
Strahlabstand 30 mm	88,3	16,1
Strahlabstand 50 mm	108,3	16,1

¹⁾ Abstand: MLG-2 Kante - erster Strahl

²⁾ Abstand: MLG-2 Kante - letzter Strahl

³⁾ MLG20x-xx**40**: 68,3 mm
 MLG20x-xx**80**: 78,3 mm

- ① First beam
- ② Last beam
- ③ Detection height (see technical data)

- ④ Beam separation
- ⑤ Optical axis
- ⑥ Status indicator: green, yellow, red LEDs
- ⑦ Connection

Adjustments

Adjustments



① Status indicator: green, yellow, red LEDs

Connection type and diagram

Connector M12, 5/8-pin, analog outputs Q_A



Pin assignment

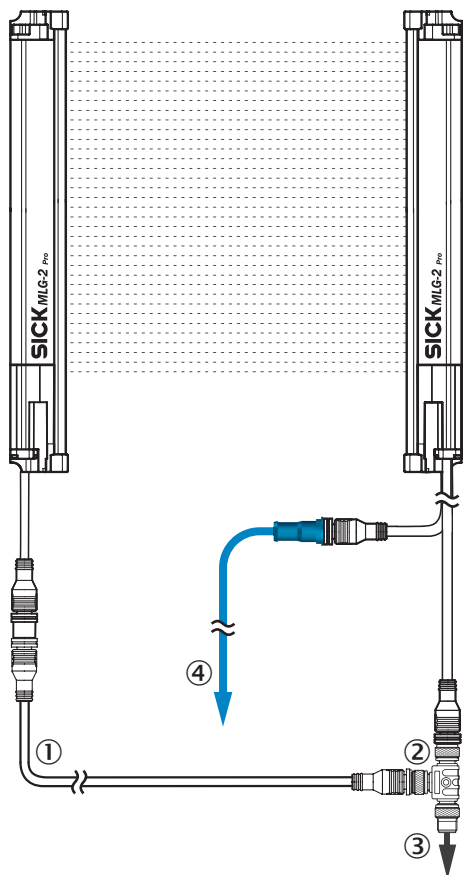

- ① Connection cable receiver (2096010)
- ② T-piece
- ③ Connection cable (6020664)
- ④ Ethernet Connection cable

Connection diagram

T-junction, PLC



T-junction, IO-Link-Master



Recommended accessories

Other models and accessories → www.sick.com/MLG-2

	Brief description	Type	Part no.
Distributors			
	<ul style="list-style-type: none"> • Connection type head A: Female connector, M12, 5-pin, A-coded • Connection type head B: Female connector, M12, 8-pin, A-coded • Connection type head C: Male connector, M12, 8-pin, A-coded • Note: Male connector M12, 8-pin, to 1 x female connector M12, 8-pin, to 1 x female connector M12, 5-pin, for connecting of a PLC 	SBO-02F12-SM1	6053172
Plug connectors and cables			
	<ul style="list-style-type: none"> • Connection type head A: Female connector, M12, 8-pin, straight • Connection type head B: Flying leads • Signal type: Sensor/actuator cable • Cable: 5 m, 8-wire, PVC • Description: Sensor/actuator cable, special color code, shielded • Connection systems: Flying leads 	DOL-1208-G05MF	6020664
	<ul style="list-style-type: none"> • Connection type head A: Female connector, M12, 5-pin, straight, A-coded • Connection type head B: Male connector, M12, 5-pin, straight, A-coded • Signal type: Sensor/actuator cable • Cable: 5 m, 5-wire, PUR, halogen-free • Description: Sensor/actuator cable, unshielded • Application: Zones with oils and lubricants, Drag chain operation, Robot 	YF2A15-050UB5M2A15	2096010
	<ul style="list-style-type: none"> • Connection type head A: Male connector, M12, 4-pin, straight, D-coded • Connection type head B: Male connector, RJ45, 4-pin, straight • Signal type: Ethernet, PROFINET • Cable: 5 m, 4-wire, PUR, halogen-free • Description: Ethernet, PROFINET, shielded • Application: Drag chain operation, Zones with oils and lubricants 	YM2D24-050PN1MRJA4	2106184
Sensor Integration Gateway			
	<ul style="list-style-type: none"> • Further functions: Web server integrated, USB connection for easy configuration of the SIG200 Sensor Integration Gateway with SOPAS ET, the engineering tool from SICK, logic editor is available for easy configuration of logic functions • Connection CONFIG: 1 x M8, 4-pin female connector, USB 2.0 (USB-A) • Logic editor: yes • Communication interface: IO-Link, USB, Ethernet, PROFINET, REST API • Product category: IO-Link Master 	SIG200-0A0412200	1089794
	<ul style="list-style-type: none"> • Further functions: Web server integrated, USB connection for easy configuration of the SIG200 Sensor Integration Gateway with SOPAS ET, the engineering tool from SICK, logic editor is available for easy configuration of logic functions • Connection CONFIG: 1 x M8, 4-pin female connector, USB 2.0 (USB-A) • Logic editor: yes • Communication interface: IO-Link, USB, Ethernet, REST API • Product category: IO-Link Master 	SIG200-0A0G12200	1102605

SICK AT A GLANCE

SICK is one of the leading manufacturers of intelligent sensors and sensor solutions for industrial applications. A unique range of products and services creates the perfect basis for controlling processes securely and efficiently, protecting individuals from accidents and preventing damage to the environment.

We have extensive experience in a wide range of industries and understand their processes and requirements. With intelligent sensors, we can deliver exactly what our customers need. In application centers in Europe, Asia and North America, system solutions are tested and optimized in accordance with customer specifications. All this makes us a reliable supplier and development partner.

Comprehensive services complete our offering: SICK LifeTime Services provide support throughout the machine life cycle and ensure safety and productivity.

For us, that is “Sensor Intelligence.”

WORLDWIDE PRESENCE:

Contacts and other locations –www.sick.com