

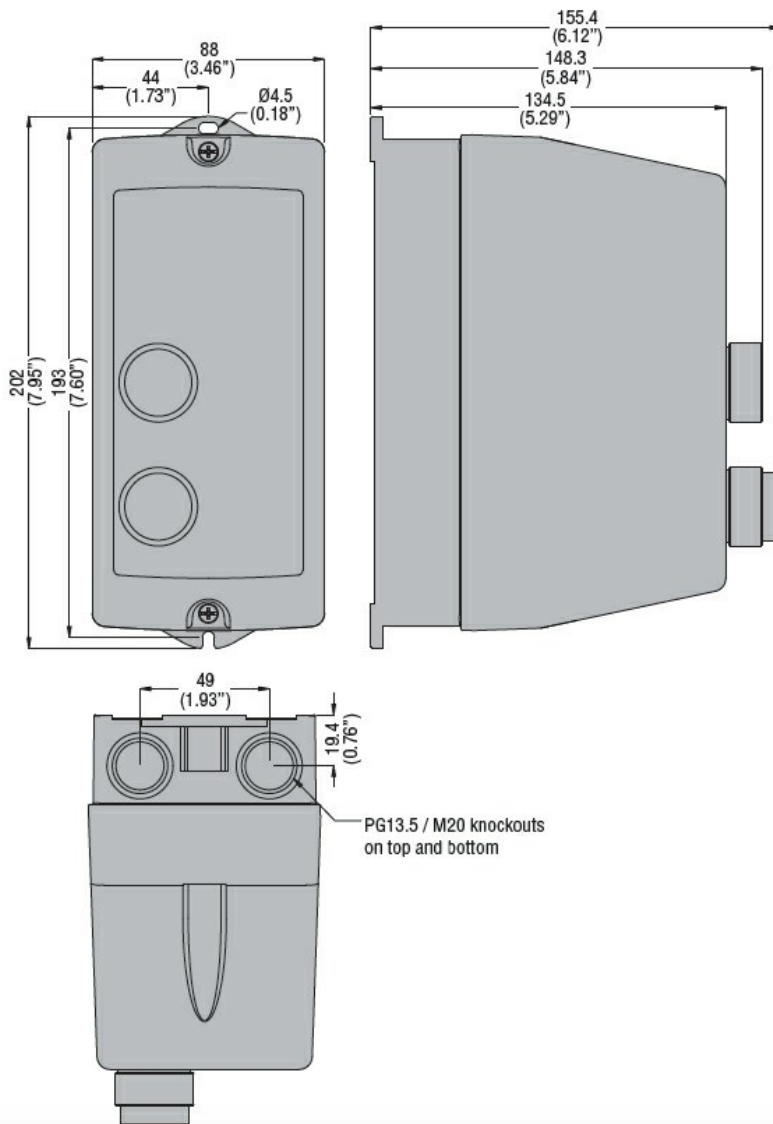

Product designation	Direct-on-line starter		
Product type designation	M1P00910		
Electrical features			
Maximum operating current ($\leq 440V$)	A	13	
Components			
Starter enclosure standard supplied	M1PA		
Contactor standard supplied	BF0910A		
Thermal relay to purchase separately	RF38...		
Mechanical features			
Weight	g	910	
Ambient conditions			
Operating temperature	min	°C	-25
	max	°C	+60
Storage temperature	min	°C	-40
	max	°C	+70
Resistance & Protection			
Frontal IP degree	IP65		
Dimensions			

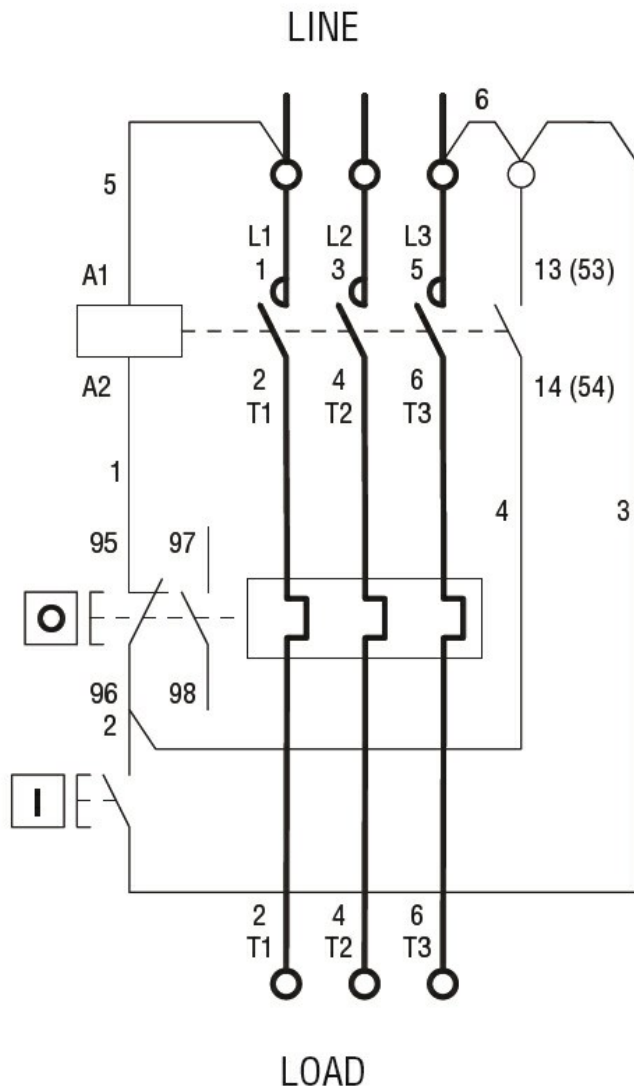

Wiring diagrams



I = Start; O = Stop/Reset

Certifications and compliance

Compliance

IEC/EN 60947-1
IEC/EN 60947-4-1
UL508 CSA C22.2 n° 14

Certificates

CSAus
cULus
EAC

ETIM classification

ETIM 8.0

EC001037 -
Motor
starter/Motor
starter
combination