

	<h2>Application software</h2>	
<ul style="list-style-type: none"> ▲ Manufacturers ▲ Hager Electro ▲ Lighting <li style="background-color: #e0ffe0; padding: 2px;"> Dimmer 	<p>Gateway KNX-DALI 2 Secure <i>Electrical/Mechanical characteristics: see product user manual</i></p>	

	Product reference	Product designation	Application software ref	TP device Radio device
	TYFS671D	Gateway KNX-DALI 2 Secure, 1 Output, 4 modules	STYFS671D	
	TYFS672D	Gateway KNX-DALI 2 Secure, 2 Outputs, 4 modules	STYFS672D	

Table of contents

1	Information on the product	5
1.1	Product catalogue	5
1.2	Function	5
1.3	Device components	9
1.4	As-delivered state	11
1.5	Technical data.....	12
2	Safety instructions	14
3	Mounting and electrical connection	15
4	Commissioning	17
5	Application programs	20
6	Scope of functions	21
7	Notes on software	24
8	Description of group- and device-independent functions	25
8.1	DALI system and addressing types	25
8.1.1	DALI system.....	25
8.1.2	Addressing types.....	27
8.1.3	DALI device types	33
8.1.4	Parameters for DALI system and addressing types	35
8.2	Operation and indication	40
8.2.1	Button operation and indication functions	40
8.2.2	ETS configuration.....	46
8.2.3	Parameters for operation and indication	53
8.3	Priorities	58
8.4	DALI communication.....	60
8.4.1	Parameters for DALI communication	62
8.5	Central functions	63
8.5.1	Parameters for central functions	64
8.5.2	Objects for central functions.....	66
8.6	Status functions	67
8.6.1	Collective feedback switching status.....	67
8.6.2	DALI feedback telegrams	70
8.6.3	DALI error status	73
8.6.4	Parameters for status functions.....	80
8.6.5	Objects for status functions.....	84
8.7	Global switching status / Standby switch-off.....	87

8.7.1	Standby switch-off.....	87
8.7.2	Global switching status.....	89
8.7.3	Parameters for global switching status / standby switch-off.....	90
8.7.4	Objects for global switching status / standby switch-off.....	91
8.8	Time and day of the week (timer function).....	92
8.8.1	Parameters for time and day of the week	93
8.8.2	Objects for time and day of the week.....	93
9	Description of group and device functions.....	94
9.1	Controlling the brightness	94
9.1.1	Dimming characteristic curves	99
9.1.2	Parameters for brightness	105
9.1.3	Objects for brightness	109
9.2	Controlling the colour temperature.....	110
9.2.1	Parameters for colour temperature	119
9.2.2	Objects for colour temperature.....	124
9.2.3	Human Centric Lighting (HCL)	126
9.3	Colour control.....	137
9.3.1	Parameters for colour control.....	143
9.3.2	Colour control objects.....	149
9.3.3	Automatic colour wheel sequence	153
9.3.4	Automatic brightness cycle.....	162
9.3.5	Colour Transition Mode (CTM).....	171
9.4	Response after a device reset	181
9.4.1	Parameters for device reset	190
9.5	Supplementary functions	195
9.5.1	Disabling function	195
9.5.2	Forced position.....	199
9.5.3	Parameter for supplementary functions	202
9.5.4	Objects for supplementary functions	211
9.6	Status functions	212
9.6.1	Switching status and brightness value	212
9.6.2	Colour temperature	216
9.6.3	Colour.....	219
9.6.4	Reset behaviour and cyclical transmission	220
9.6.5	Parameters for status functions.....	222
9.6.6	Objects for status functions.....	230
9.7	Switch-on and switch-off behaviour	233
9.7.1	Switch-on and switch-off delays.....	233

9.7.2	Soft ON/OFF function.....	234
9.7.3	Automatic switch-off	235
9.7.4	Parameters for switch-on/switch-off behaviour	238
9.8	Staircase function	242
9.8.1	Parameters for staircase function.....	252
9.8.2	Objects for staircase function	256
9.9	Operating hours counter	257
9.9.1	Parameters for operating hours counter	262
9.9.2	Objects for operating hours counter	264
10	Scene function	266
10.1	Parameters for scenes	274
10.2	Objects for scenes	280
11	Device Configuration App (DCA)	281
11.1	DALI commissioning	283
11.1.1	Indication and operating elements in the DCA.....	283
11.1.2	Performing DALI commissioning	294
11.1.3	Complete DALI commissioning	312
11.2	DALI test	314
11.2.1	Test "All devices (DALI)"	316
11.2.2	Test "Devices (DALI)"	317
11.2.3	Test "Groups (KNX)"	319
11.2.4	Test "Single Devices (KNX)"	321
11.2.5	Test "Scenes (KNX)"	323
12	Appendix.....	325

1 Information on the product

1.1 Product catalogue

Products:	DALI Gateway 1 channel (TYFS671D) DALI Gateway 2 channels (TYFS672D)
Use:	Gateway
Design:	RMD (rail-mounted device)

1.2 Function

DALI

The gateway is the interface between a KNX installation and a digital DALI (**D**igital **A**dressable **L**ighting **I**nterface) lighting installation. Depending on the device variant, the gateway enables the switching and dimming of DALI operating devices in either one DALI system (1 x 64 operating devices, 1-gang device variant) or in two separate DALI systems (2 x 64 operating devices, 2-gang device variant).

Up to six different addressing types allow group-orientated and individually addressed control of DALI lights by means of KNX telegrams. This allows the integration of room-specific light control, for example of open-plan offices, multipurpose spaces, production facilities, training and presentation rooms or showcases, into the higher-level KNX building management. Depending on the configuration, up to 32 independent DALI groups are available for group addressing. For alternative control, they can be supplemented with 64 individually addressable DALI device channels for each DALI system, if necessary.

Optionally, master control of all connected DALI components is possible (broadcast). This means that there is no need for DALI commissioning, meaning that lighting systems with low functional requirements can be commissioned quickly and easily.

The gateway is certified as a DALI-2 control device in accordance with IEC 62386 Ed. 2.

i The complete functionality of the DALI system can only be ensured if DALI-2 operating device is used exclusively. It is recommended to use DALI-2 operating devices. A complete list of DALI-2 operating and control devices is available via the following link: <https://www.dali-alliance.org/products>

Colour temperature control (DALI Device Type 8 - TW)

The gateway supports the control of DALI operating devices of device type "Tunable White." This makes it possible to control the colour temperature of a luminaire by means of suitable DALI operating devices and lamps. The gateway allows the colour temperature to be controlled by relative or absolute dimming and additionally by scenes.

In addition, it is possible to implement a daytime colour temperature sequence to implement biologically effective lighting (HCL: **H**uman **C**entric **L**ighting). For this purpose, up to four HCL matrices are available that can be freely configured in terms of brightness and colour temperature and activated and switched over depending on the time of day and day of the week as well as user-controlled.

The colour temperature is controlled for each group and each single device independently of the brightness control by means of separate communication objects and can be used for each channel as an alternative to the colour control.

Colour control (DALI Device Type 8 - RGBW Colour Control)

The gateway can be used to implement the control the light colour using DALI operating devices of device type "Colour Control". The gateway enables flexible colour control in the colour spaces "RGB", "RGBW", "HSV" or "HSVW". In the RGB colour spaces, the colour can be controlled by relative or absolute dimming by means of either combined or separate communication objects according to the KNX specification. In the "HSV" colour space, separate objects are always available for the absolute control of the light colour by the hue (H), saturation (S) and brightness value (V). It is also possible to integrate colour control in scenes.

Furthermore, it is possible to implement a colour gradient for the implementation of different colour moods depending on the time of day and day of the week (CTM: **C**olour **T**ransition **M**ode). Up to four freely configurable CTM matrices are available for this purpose. Each matrix allows the setting of individual colour preferences, with or without brightness adjustment. The matrices can be activated and switched over individually during operation of the gateway.

The colour control is completed by running automatic colour wheel and brightness sequences. The colour wheel sequence is used for the automatic overall colour control of DALI lights. This function uses the cyclical adjustment of the hue in the colour wheel. This results in continuous colour gradients that can be started and stopped at will during the running time of the gateway.

The automatic brightness sequence works in the same way. This function cyclically adjusts the brightness within the entire brightness range and thus creates individual brightness scenarios.

Groups and single devices

The gateway enables KNX status indication of the individual switching and brightness statuses and also of the colour temperature or colour of the groups and single devices. In addition, the general DALI state of operation can be signalled to the KNX (error status, short-circuit, state of the supply voltage, utilisation of the DALI interface). The function features that are independently adjustable for every light group or each single device by means of the ETS include, for example, separately configurable brightness ranges, extended feedback functions, a disabling function, or alternatively, a forced position function, separately adjustable dimming behaviour, time delays, soft dimming functions, a staircase function with supplementary functions and an operating hours counter. Moreover, the brightness values of the groups of single devices in case of bus voltage failure or bus voltage return and after ETS programming, can be preset separately. Central switching is possible, too.

For DALI DT8-compatible operating devices, the following functions can be addition-

ally configured: definition of the controllable colour or colour temperature range by minimum and maximum limit values, switch-on colour or colour temperature, relative and absolute dimming with KNX status indication. Furthermore, it is also possible to automatically change the colour temperature proportionally when dimming the brightness. This makes it possible with little project planning to simulate a thermal radiator using almost any colour temperature controllable lamp (perception of the light source such as an incandescent or halogen lamp).

Scenes

Luminaires or luminaire groups can optionally be integrated in up to 16 scenes, which means that pre-programmed static light scenes can be recalled by influencing the brightness, colour temperature or colour. If necessary, the scene values can be switched over and individually adapted and saved during operation of the device, allowing the user to replace the presettings of the ETS as desired. The extended scene recall allows scenes to be switched over by switching commands.

ETS project design and Device Configuration App (DCA)

To carry out the DALI commissioning and the DALI test, a completely ETS-integrated Device Configuration App, which supplements the standard parameter dialogue, is used. This enables the identification, addressing and assignment of DALI control gears by using the familiar ETS environment without having to use additional software beyond the ETS.

The DALI short addresses are assigned in the parameter configuration of the single devices and can thus be individually influenced. With the addition of group and device names, unique naming of DALI operating devices is possible in this way. Due to the transmission of the unique names to the KNX building visualisation (e.g. control panels), the user is able - particularly during error diagnosis - to identify the lighting components easily.

Project design and commissioning of the device is possible using ETS5 or ETS6.

DALI compatibility

The gateway has a compatibility mode for supporting non-DALI-conformant operating devices. This means that the commissioning process becomes distinctly more tolerant towards specific DALI commissioning parameters, which means that operating devices not fully compliant with the DALI specification can be commissioned, possibly subject to functional restrictions. In addition to this, a DALI telegram rate limit can be activated, meaning that adaptation to non-DALI-conformant operating devices is also possible.

Manual operation and mounting

The operating elements (4 buttons) on the front panel of the device allow the DALI light groups or single devices of both DALI systems (with 2-gang device variant) to be switched on and off or dimmed in brightness by manual operation in parallel with the KNX even without bus voltage or in a non-programmed state (broadcast of all connected DALI devices). This feature permits fast checking of connected loads for

proper functioning. In addition, the gateway is able to check the completeness of the operating devices integrated in the DALI system. This means that it is possible to detect the replacement of a defective electronic ballast with a new one. The automatic device replacement fulfils this function, which makes it considerably easier to repair a DALI system.

The gateway is supplied completely via the mains voltage connection and provides the DALI system voltage. The mains voltage must be switched on to control the DALI interface or for programming by the ETS! The device is designed for mounting on DIN rails in closed compact boxes or in distributors in fixed installations.

1.3 Device components

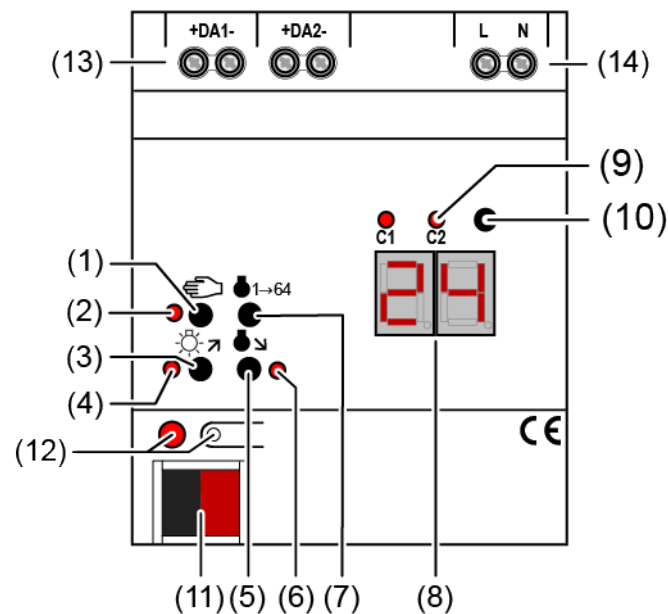

Figure 1: Device components

- (1) Button Manual operation
- (2) LED On: continuous manual mode active
Flashing: temporary manual mode active
- (3) Button Short press (< 1 s): ON / long press (1...5 s): dims brighter.
- (4) LED LED ON in manual operation indicates a switched-on group/single device (brightness: 1...100 %).
- (5) Button Short press (< 1 s): OFF / long press (1...5 s): dims darker.
- (6) LED LED ON in manual operation indicates a switched-off group/single device (brightness: 0 %).
- (7) Button All DALI subscribers OFF (only in permanent manual operation).
- (8) Seven-segment display for indication of the number (1...16, 1...32) of a DALI group (8a) or the short address (1...64) of a single device (8b) selected by manual operation. In bus mode, there is no indication of the group number or short address. In addition, to display additional information:
- -: signals DALI initialisation phase, delay after ETS programming operation / mains voltage return or temporary status indication.
bc: indication during manual operation in broadcast mode (unprogrammed state, central control).

Er: indication of an impermissible external voltage at the DALI device connection terminals (e.g. mains voltage connected). DALI gateway without function. The gateway is not ready for operation again until the error has been eliminated and initialisation has been performed again (mains voltage return).

db: a high telegram load has been detected in the DALI system signalled by the LED (9). This high load can lead to disturbed operation (noticeable delays, telegram loss).

LE: signals automatic device replacement.

E: signals an error during automatic device replacement.

- (9) LED of the active DALI system for manual operation (only with 2-gang device variant).
Permanently ON in manual mode or briefly ON (5 s) after pressing the changeover key in ongoing normal mode.
- (10) Change-over button for DALI systems 1 and 2 (only with "2fold" device variant)
- (11) KNX connection
- (12) Programming button and LED
- (13) Device connection terminals for DALI systems 1 & 2 (number depends on the device variant)
- (14) Terminals for mains supply

1.4 As-delivered state

In the as-delivered state of the gateway, the device is passive, i. e. no telegrams are transmitted to the KNX. Joint operation of the connected DALI operating devices by broadcast manual operation on the device, if the mains voltage is on. With manual operation, no feedback telegrams are sent to the KNX. Other functions of the gateway are deactivated. The device can be programmed and put into operation via the ETS (if the bus and mains voltage supply are connected and switched on). The physical address is preset to 15.15.255

Furthermore, the device has been configured at the factory with the following characteristics...

- Manual operation: broadcast
- Dimming speed, manual operation (0...100%): 3.5 seconds
- Minimum brightness: 1%
- Maximum brightness: 100%
- Response to bus voltage failure: No reaction.
- Response to bus voltage return: No reaction.
- Behaviour after the mains voltage supply returns at the gateway: no reaction from the gateway. When the mains voltage returns, the DALI operating devices usually initialise themselves to the "power-on level" most recently programmed or specified by the manufacturer.
- Operating hours counter reading: 0

 The delivery state (broadcast manual operation) can be restored at any time by unloading the application program using the ETS.

 In the delivery state, no colour temperature control or colour control is possible.

1.5 Technical data

KNX

KNX medium	TP 256
KNX commissioning mode	S mode
Rated voltage KNX	DC 21 ... 32 V SELV
Current consumption KNX	4.5 ... 5.0 mA
Connection type for bus	Device connection terminal

Supply

Rated voltage	AC 110 ... 240 V ~
Mains frequency	50 / 60 Hz
Rated voltage	DC 110 ... 240 V
Power loss	max. 3 W

DALI

Rated voltage DALI	DC 16 V (typ.)
Output current per DALI system	Typ. 128 mA, max. 250 mA for short periods
Guaranteed bus current per DALI system	148 mA

i The gateway provides a maximum bus current of 250 mA for each DALI system connection. For this reason, it is not permissible to connect another DALI power supply to the controlled DALI systems.

Number of DALI subscribers	Max. of 64 per DALI system
DALI transmission rate	1.2 kBit/s
DALI protocol	EN 62386
Cable type	Sheathed cable 230 V, e. g. NYM
DALI cable length	

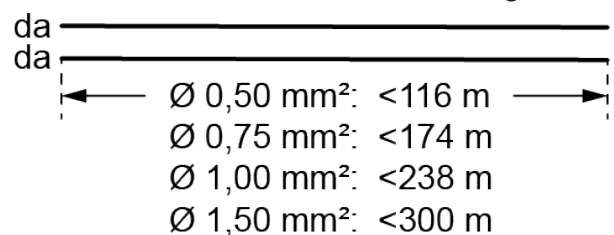

Ambient conditions

Ambient temperature	-5 ... +45°C
Storage temperature	-5 ... +45°C
Transport temperature	-25 ... +70°C

Clampable cable cross-sections

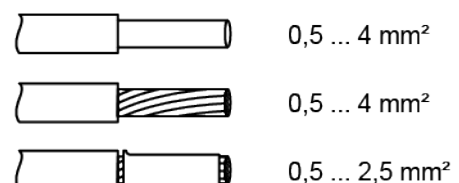

Installation width	72 mm / 4 HP
Connection mode	Screw terminal
Connection torque, screw terminals	max. 0.8 Nm

2 Safety instructions



Electrical devices may be mounted and connected only by electrically skilled persons.

Serious injuries, fire or property damage are possible. Please read and follow the manual fully.

Danger of electric shock. Always disconnect before carrying out work on the device or load. In so doing, take all the circuit breakers into account, which support dangerous voltages to the device and or load.

DALI is an FELV (functional extra-low voltage). On installing, ensure safe isolation between KNX and DALI and mains voltage. A minimum distance of at least 4 mm must be maintained between bus conductors and DALI/mains voltage cores.

3 Mounting and electrical connection



DANGER!

Electric shock when live parts are touched.

Electric shocks can be fatal.

Always disconnect device before carrying out work on it. For this, switch off all corresponding circuit breakers, secure against being switched on again and check that there is no voltage. Cover up adjacent live parts.

Mount device

- Mount device on DIN rail.

Connect device

Control cable: appropriate type, cross-section and routing for the specifications for 230 V cables. DALI and mains voltage wires can be run together in a cable, e.g. NYM 5x1.5 mm².

- The DALI control voltage is a functional extra-low voltage (FELV). When installing, perform the installation in such a way that when an area is disconnected, the lines carrying both the DALI and also the mains voltage are disconnected.
- If multiple circuit breakers supply dangerous voltages to the device or load, couple the circuit breakers or label them with a warning to ensure tripping.
- DALI participants from some manufacturers have expanded functions and can be controlled, for example, via mains voltage on the DALI connection. When existing DALI installations are refitted, remove all corresponding operator controls.
- Attach the cover cap to the bus cable connection as protection against hazardous voltages.

If the display (8) shows **Er** (error), an installation fault occurred that causes mains voltage to reach the DALI cable. In this case disconnect the device and the DALI devices from mains voltage and disconnect bus voltage. Correct installation.

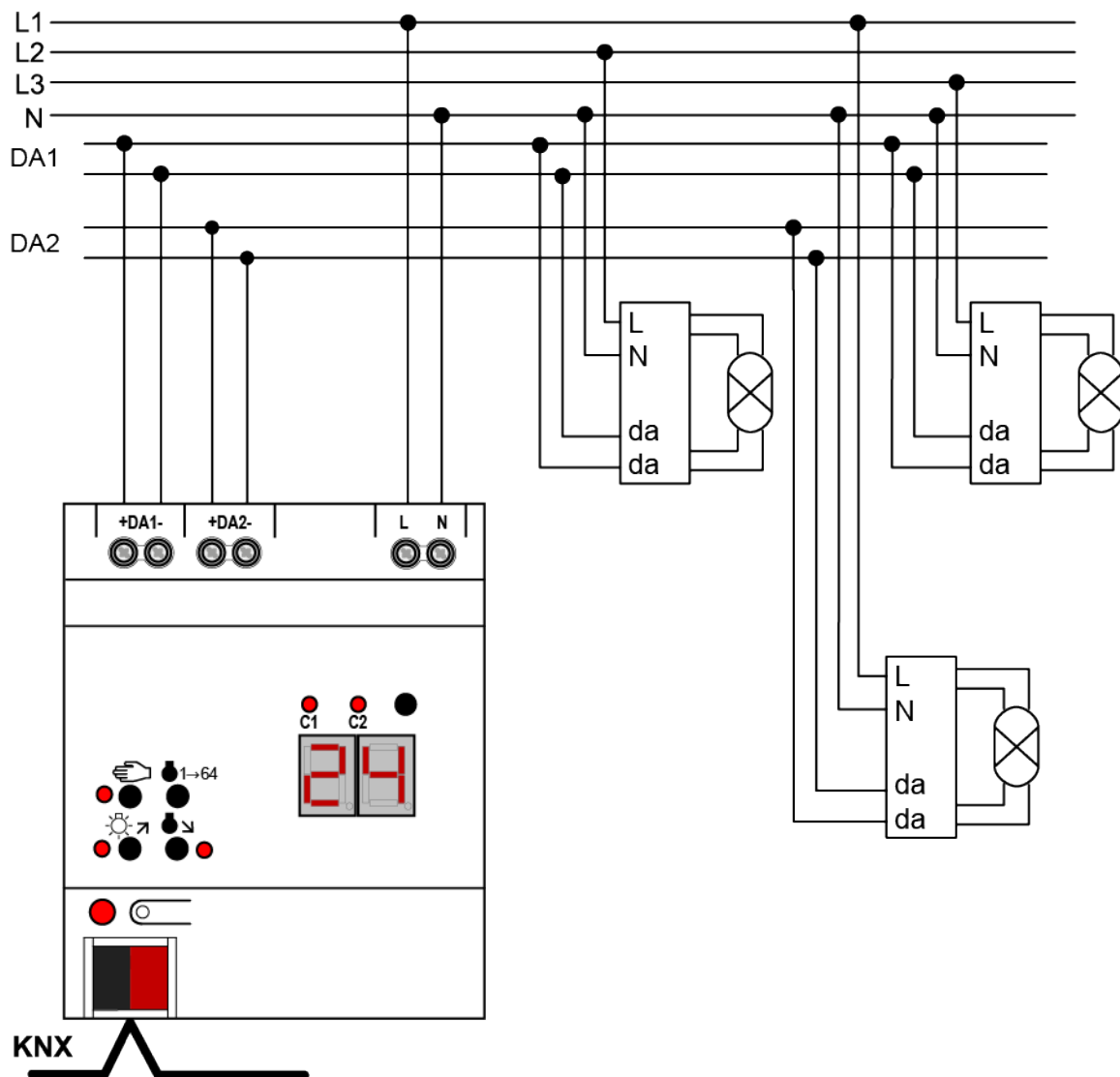

Figure 2: DALI gateway connection example, 2fold

- Connect device as shown in the connection example (see figure 2)
- i** The mains voltage supply can also be provided by the DC voltage of an emergency lighting system.
- i** The gateway provides a maximum bus current of 250 mA for each DALI system connection. For this reason, it is not permissible to connect another DALI power supply to the controlled DALI systems.
- i** The DALI power supply integrated in the gateway is short-circuit-proof. The gateway detects short-circuits on the DALI cable, as may occur in the case of an installation error. As soon as a short circuit is identified with the mains the gateway switches off the DALI system voltage. In these cases, a short-circuit status can optionally be sent out on the KNX. The gateway checks at intervals of approx. 10 s whether an identified short circuit is still present. If the short circuit has been eliminated, the gateway automatically switches the DALI system voltage back on and continues to operate in normal mode.

4 Commissioning

The device can be put into operation, after mounting of the device and connection of the bus line, the mains supply and the DALI cables. The following procedure is generally recommended...

Commissioning the device

- Switch on the mains supply of the gateway.
- Switch on the bus voltage.

Voltage check: When the programming button is pressed, the red programming LED must light up.

- Configure and program the physical address with the help of the ETS
- Download the application program using the ETS.
- Commission the DALI system using commissioning software (DCA).
- Download the application program using the ETS again.

The gateway is ready for operation.

i It is not explicitly necessary to carry out DALI commissioning and reprogram the application program if the gateway has been integrated into an existing DALI installation (e.g. when replacing a device of the same type) and continues to be used with an unchanged DALI configuration (same short addresses, device types, group assignments, etc.). This is the case, for example, if a device is copied unchanged in the ETS project design or a configuration template is imported.

i No ETS programming is possible if no mains voltage supply is connected.

Safe-state mode

If the device does not work properly - for instance as a result of errors in the project design or during commissioning - the execution of the loaded application program can be halted by activating the safe-state mode. In safe-state mode it is not possible to control the DALI operating devices via the KNX or by manual operation. The gateway remains passive in safe-state mode, since the application program is not being executed. Only the system software is still functional so that the ETS diagnosis functions and also programming of the device continue to be possible.

Activating safe-state mode

There are two options for activating the safe state mode.

Option 1:

- Switch off the mains voltage supply.
- Wait approx. 10 seconds.
- Press and hold down the programming button.

- Switch on the mains supply. Release the programming button only after the programming LED starts flashing slowly.
The safe-state mode is activated.

Option 2:

Prerequisite: The mains voltage supply must be switched on without interruption.

- Switch off the bus voltage or disconnect the bus terminal.
- Press and hold down the programming button.
- Switch on the bus voltage or attach the bus terminal. Release the programming button only after the programming LED starts flashing slowly.
The safe-state mode is activated.

i Even in safe-state mode, a brief press of the programming button can switch the programming mode on or off as usual as long as the bus power supply is switched on. The programming LED then stops flashing, even though safe-state mode is still active.

Deactivating safe-state mode

- Switch off the mains voltage supply (wait approx. 10 s),
or
- Perform the ETS programming operation,
or
- Cause bus voltage failure.

Master reset

The master reset restores the basic device settings (physical address 15.15.255, firmware remains in place). The device must then be recommissioned with the ETS. Manual operation is possible.

In secure operation: A master reset deactivates device security. The device can then be recommissioned with the device certificate.

Performing a master reset

Precondition: The safe-state mode is activated.

- Press and hold down the programming button for > 5 s.
The programming LED flashes quickly.

The device performs a master reset, restarts and is ready for operation again after approx. 5 s.

Restoring the device to factory settings

The device can be reset to factory settings with the Hager/Berker Firmware Update App. This function uses the firmware contained in the device that was active at the time of delivery (delivered state). Restoring the factory settings causes the device to lose its physical address and configuration.

5 Application programs

ETS search paths: Lighting / Dimmer / DALI Gateway 1 channel
Lighting / Dimmer / DALI Gateway 2 channels
Configuration: S-mode standard

Applications:

For "1-gang" device variant:

Name DALI Gateway Colour C03121
Version 2.1 for ETS5 version 5.7.7 or higher, or ETS6 version 6.1.0 or higher.
from mask version SystemB (07B0)

For "2-gang" device variant:

Name DALI Gateway Colour C03021
Version 2.1 for ETS5 version 5.7.7 or higher, or ETS6 version 6.1.0 or higher.
from mask version SystemB (07B0)

6 Scope of functions

General:

- Depending on the device version, either one DALI system (1-gang device version) or in two separate DALI systems (2-gang device version).
- Switching and dimming of 64 luminaires with a DALI operating device (e.g. electronic ballast) for each DALI system.
- Up to six different addressing types allow the group-orientated and individually addressed control of DALI lights by means of KNX telegrams.
- Up to 32 independent DALI groups are available for group addressing. For alternative control, these can be supplemented with 64 individually-addressable DALI device channels, as necessary.
- Support of the control of DALI operating devices of device type "Tunable White" (DALI Device Type 8 - TW). Colour temperature control via relative or absolute dimming as well as via scenes and effects. The colour temperature control is largely independent of the brightness control and lamp used.
- Implementation of a daytime colour temperature gradient to implement biologically effective lighting possible (HCL: **H**uman **C**entric **L**ighting). For this purpose, up to four HCL matrices are available that can be freely configured in terms of brightness and colour temperature and activated and switched over depending on the time of day and day of the week as well as user-controlled.
- Control of the light colour when using DALI operating devices of device type "Colour Control" (DALI Device Type 8 - RGBW Colour Control). The gateway enables flexible colour control in the "RGB", "RGBW" or "HSV" colour spaces. In the RGB colour spaces, the colour can be controlled by relative or absolute dimming by means of either combined or separate communication objects according to the KNX specification. In the "HSV" colour space, separate objects are always available for the absolute control of the light colour by the hue (H), saturation (S) and brightness value (V).
- Implementation of a colour gradient for time-of-day and day-of-week-dependent implementation of different colour moods possible (CTM: **C**olour **T**ransition **M**ode). Up to four freely configurable CTM matrices are available for this purpose. Each matrix allows the setting of individual colour preferences, with or without brightness adjustment. The matrices can be activated and switched over individually during operation of the gateway.
- With colour control: execution of automatic colour wheel and brightness sequences. The colour wheel sequence is used for the automatic overall colour control of DALI lights. This function uses the cyclical adjustment of the hue in the colour wheel. This results in continuous colour gradients that can be started and stopped at will during the running time of the gateway. The automatic brightness sequence works in the same way. This function cyclically adjusts the brightness within the entire brightness range and thus creates individual brightness scenarios.

- Optional master control of all connected DALI components is possible (broadcast). This means that there is no need to commission DALI, meaning that lighting systems with few functions can be started up quickly and easily (simplified configuration without DALI commissioning).
- Manual operation of groups and single devices independently of the bus (also building site operation with broadcast control) separately for the DALI systems. Control of the switching status and brightness.
- Feedback of DALI error status, DALI busy and DALI short-circuit and message that the supply voltage has failed.
- Up to six central switching and dimming functions.
- Global switching status and standby switch-off of the connected electronic ballast can be implemented. Collective feedback of all switching states possible.
- It is possible to include groups and single devices in up to 16 light scenes per DALI system to control the brightness, colour temperature or colour.
- Carrying out the DALI commissioning and the DALI test due to a completely ETS-integrated Device Configuration App, which supplements the standard parameter dialogue.

Group and device functions:

- Each group and single device offers the full scope of functions without any restrictions. All channel-oriented functions can be parameterised separately for each group or single device. This feature permits independent and multi-functional control of the DALI operating devices.
- Active status messages for switching state, brightness value, colour temperature and colour possible.
- Setting of brightness and colour temperature limit values (minimum, maximum) possible.
- Dimming behaviour and dimming characteristics configurable.
- Lamp preserving switch on and switch off (soft ON or soft OFF).
- Disabling function, or alternatively, forced position function is configurable. During a disabling function, the flashing of luminaire groups and single devices is not possible.
- Time functions (switch-on delay, switch-off delay, staircase lighting function, also with pre-warning function).
- Operating hours counter
- DALI power ON level adjustable (by behaviour "after bus/mains voltage return" parameter) and DALI system failure level (adjustable by behaviour "at bus/mains voltage failure" parameter).
- Reactions in the event of bus/mains voltage failure and return as well as after an ETS programming operation can be set (for brightness control). Fixed for colour temperature control and colour control.

ETC Device Configuration App (DCA)

- Convenient DALI commissioning without external software components. The identification, addressing and assignment of DALI operating devices takes place in the DALI commissioning environment of the DCA separately for both DALI systems.
- Offline DALI configuration: assignment of electronic ballast to groups or single devices also without programming connection to the device.
- The DALI short addresses can be influenced individually. With the addition of group and device names, unique naming of DALI operating devices is possible in this way.
- Testing of the DALI device types when assigning DALI operating devices to projected groups or single devices. This will prevent functional incompatibilities after commissioning.
- Compatibility mode to support non-DALI-conformant operating devices. This means that the commissioning process becomes distinctly more tolerant towards specific DALI commissioning parameters, which means that operating devices not fully compliant with the DALI specification can be commissioned, possibly subject to functional restrictions. In addition to this, a DALI telegram rate limit can be activated, meaning that adaptation to non-DALI-conformant operating devices is also possible.
- Partial DALI commissioning: When using this function, operating devices that have already been found during a DALI device search are retained even if these do not answer the gateway (for example with the mains voltage supply of these operating devices switched off or the DALI cable disconnected). This allows DALI systems to be partially commissioned.
- Test function for all created DALI groups or individual DALI operating devices: central ON/OFF switching (broadcast), device test (ON/OFF, brightness value and colour temperature specification or colour specification, device status), group test (ON/OFF, specification of brightness value and colour temperature or colour) and tests of scenes.
- Export and import of parameterisation templates in XML format.
- Documentation function to create a configuration report as a PDF (overview of group assignment or entire device configuration).
- Integrated help (technical product documentation).

7 Notes on software

ETS project design and commissioning

For project design and commissioning of this device, we recommend using the ETS6. Project design and commissioning of the device with ETS5 version 5.7.7 or ETS6 version 6.1.0 or higher is possible.

Unloading the application program

The application program can be unloaded with the ETS. In this case, only broadcast manual operation of the connected DALI operating devices is possible.

8 Description of group- and device-independent functions

8.1 DALI system and addressing types

8.1.1 DALI system

The gateway is the interface between a KNX installation and a digital DALI (Digital Addressable Lighting Interface) lighting installation. Depending on the device variant, the gateway enables the switching and dimming of DALI operating devices in either one DALI system (1 x 64 operating devices, 1-gang device variant) or in two separate DALI systems (2 x 64 operating devices, 2-gang device variant).

Up to six different addressing types allow group-orientated and individually addressed control of DALI lights by means of KNX telegrams. This allows the integration of room-specific light control, for example of open-plan offices, multipurpose spaces, production facilities, training and presentation rooms or showcases, into the higher-level KNX building management. Depending on the configuration, up to 32 independent DALI groups are available for group addressing. For alternative control, they can be supplemented with 64 individually addressable DALI device channels for each DALI system, if necessary.

The gateway is certified as a DALI-2 control device in accordance with IEC 62386 Ed. 2.

- i** The complete functionality of the DALI system can only be ensured if DALI-2 operating device is used exclusively. It is recommended to use DALI-2 operating devices. A complete list of DALI-2 operating and control devices is available via the following link: <https://www.dali-alliance.org/products>

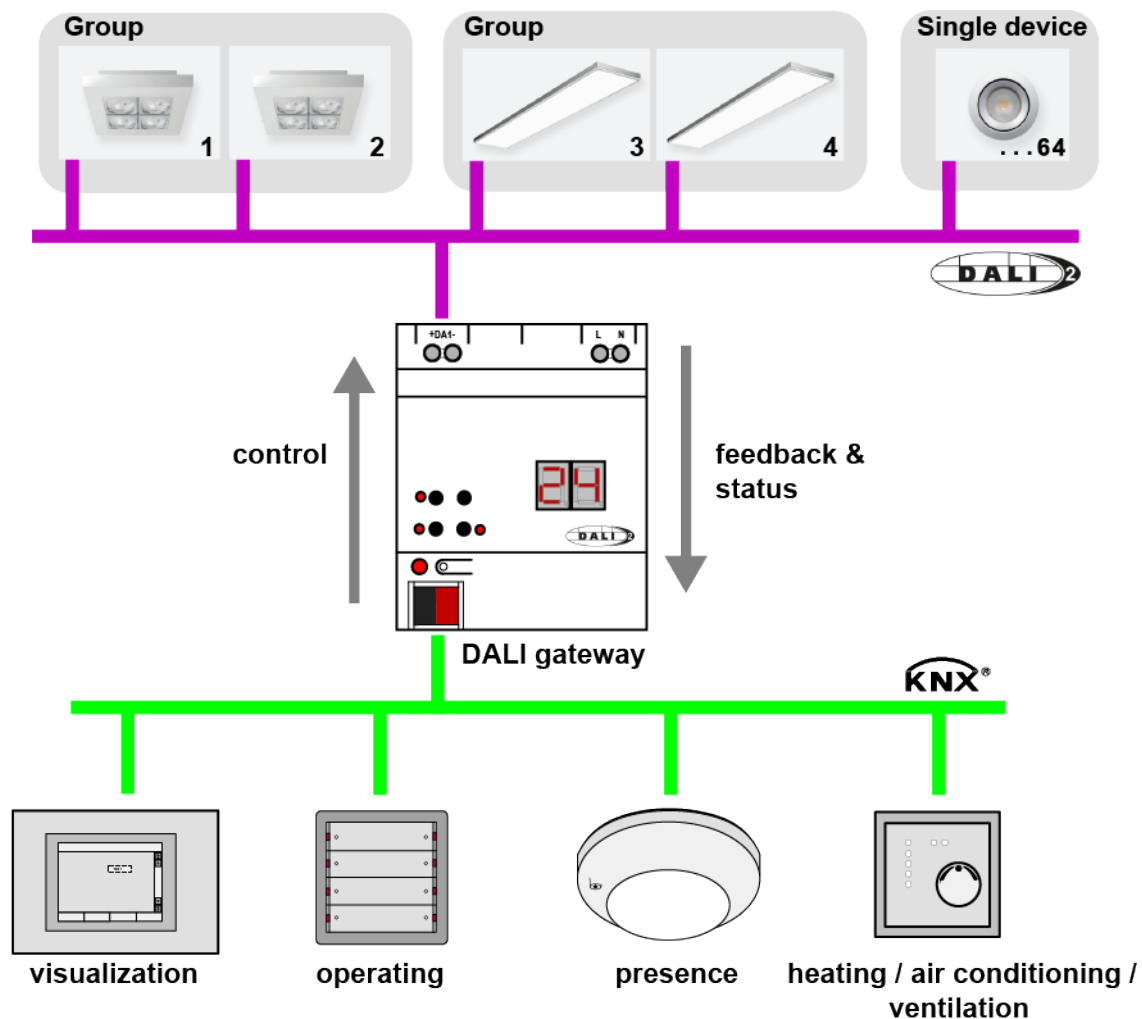

Figure 3: Principle overview of a KNX-DALI system integration (example)

The gateway functions as a master control component (master controller) within a system, which also guarantees the power supply of the DALI interface. The DALI operating devices, e.g. electronic ballasts, work as command receivers (slaves), which only return states or status messages to the master on request. It is the sole task of the gateway to transmit control commands received from the KNX onto the DALI line and to check the operating devices. The use of additional DALI control components in multi-master operation, such as an additional DALI central unit, a DALI potentiometer or push-buttons that switch the mains voltage, is superfluous and can, in individual cases, cause malfunctions in the DALI system. For this reason, it is necessary to remove other control components from the system, particularly when refitting existing DALI systems. The DALI system is then fully controlled by components of the KNX.

Communication between the KNX system and the DALI interface takes place bidirectionally via the gateway. On the one hand, the gateway receives telegrams from the KNX, which either directly influence the brightness state of a DALI group or of individual operating devices (e.g. by switching, dimming, brightness value specification or scene recall) or adjust it indirectly (e.g. with time, disabling or forced position functions). The gateway always determines the current brightness states of the groups and single devices internally and forwards brightness commands to the DALI operat-

ing devices, which then adjust themselves to the appropriate brightness. On the other hand, the internally-tracked switching or brightness states of the groups and single devices can be fed back to the KNX. It is also possible to transmit the status information of the DALI operating devices (lamp error, electronic ballast error) or gateway (mains voltage failure, DALI short-circuit) to the KNX.

The gateway supports the control of DALI operating devices of device type "Tunable White." This makes it possible to control the colour temperature of a luminaire by means of suitable DALI operating devices and lamps. The gateway allows the colour temperature to be controlled by relative or absolute dimming and additionally by scenes.

Furthermore, the light colour can be controlled when using DALI operating devices of device type "Colour Control". The gateway enables flexible colour control in the colour spaces "RGB", "RGBW", "HSV" or "HSVW". In the RGB colour spaces, the colour can be controlled by relative or absolute dimming by means of either combined or separate communication objects according to the KNX specification. In the "HSV" colour space, separate objects are always available for the absolute control of the light colour by the hue (H), saturation (S) and brightness value (V). It is also possible to integrate colour control in scenes.

Groups or single devices can be optionally integrated into 16 independent scenes. Brightness values, colour temperatures and colours can be configured separately within a scene in the ETS for each group or for individual operating devices or adjusted at any time later on during operation with scene memory telegrams.

8.1.2 Addressing types

A DALI system can address a maximum of 64 operating devices, although the gateway itself does not count as an operating device. Up to six different addressing types allow the group-orientated and individually addressed control of DALI lights by means of KNX telegrams. Depending on the configuration, up to 32 independent groups are available for group addressing. For alternative control, they can be supplemented with 64 individually addressable device channels, if necessary.

- i** Scenes are influenced by the global addressing type and by the general configuration of the groups and single devices. Therefore, the global and general parameters must be set first before the scene configuration takes place!
- Master control:
With master control, all the connected DALI components are controlled by a broadcast command. This means that there is no need to commission DALI, meaning that lighting systems with few functions can be started up quickly and easily (simplified configuration without DALI commissioning). With central addressing, some functions are not available (no error status, no automatic device replacement).

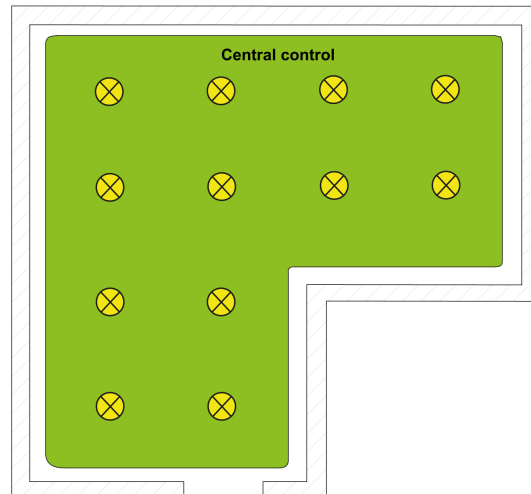

Figure 4: Example of a master control (broadcast) - Only one group

- i** No automatic device replacement is possible in manual mode because there is no DALI addressing by group and short addresses with a central control. If one or more DALI operating devices are replaced, ETS commissioning (programming of the application program) must be repeated so that all DALI runtime parameters are transferred to the operating devices.
- Group control 1...16:
During DALI commissioning, the max. 64 DALI operating devices are assigned to any number of different groups of the gateway. For this any number of DALI operating devices can be assigned to each group (1...16). On the DALI side, addressing takes place using group addresses, which the gateway configures invisibly for the user and manages on its own. During DALI commissioning, the operating devices concerned are automatically programmed accordingly. Through the use of group addresses (multicast), the reaction time of the DALI subscribers in this type of addressing is short - particularly in large-scale systems.
In the project design example, each of the luminaires shown has a DALI operating device. Four lights are in the same group. The lights combined in this way can be controlled jointly using the KNX.

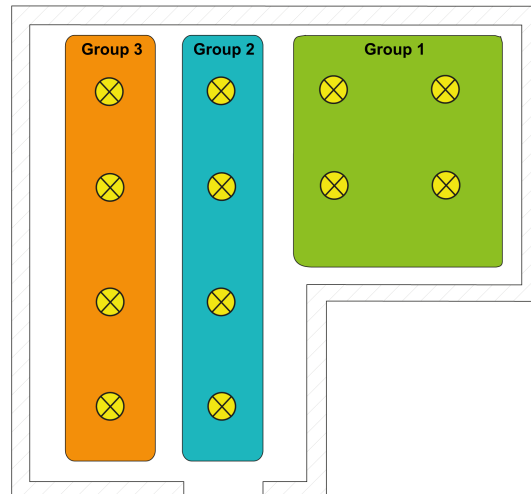

Figure 5: Example of group control with three groups - all lights with group addressing

- Group control 1...32:
With this addressing type too, the max. 64 DALI operating devices are assigned to different groups of the gateway during the DALI commissioning. For this, any number of DALI operating devices can be assigned to groups 1...16. On the DALI side, addressing takes place using group addresses, meaning that the reaction time of the DALI subscribers in groups 1...16 is short. In contrast, only up to five DALI operating devices can be assigned to groups 17...32. Since there are no DALI group addresses for these groups, DALI addressing takes place using the device short addresses, which means that the operating devices are addressed, and thus contacted, individually. In particular, in large systems with multiple devices addressed by a short address, the reaction time is slower than with group addressing, because addressing takes place separately and in sequence.
In the project design example, each of the luminaires shown has a DALI operating device. In the right-hand and middle areas of the room are two groups, each with four lights. Here, use of groups 1...16 is advisable. In another area of the room, a total of four lights is integrated into two further groups. Each of these groups contains two lights. Here, use of groups 17...32 is advisable, in particular if the lower groups are to comprise multiple operating devices (e.g. in other rooms).
If this addressing type is used, the exemplary integration of two operating devices each in up to 32 groups allows addressing of 64 devices by group control.

i The device short addresses are always assigned in the parameter configuration of the single devices and can thus be influenced. Short addresses must be unique. This means that addresses may not appear multiple times in a DALI system. The application program checks the editing of short addresses and ensures their uniqueness.

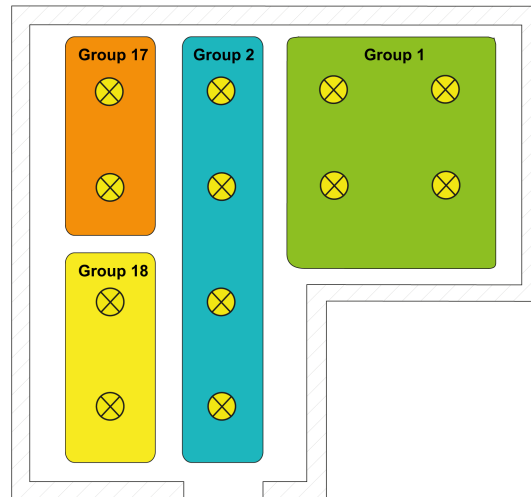

Figure 6: Example of group control with four groups - Lights in groups 17 and 18 with individual addresses

- Group control 1...16 and device control 1...64:
In this addressing type, the operating devices in groups 1...16 are controlled using DALI group addresses, as described above for group control. In addition, other DALI operating devices can be addressed individually as single devices. The addressing of these devices takes place individually using the device short addresses.
In the project design example, each of the luminaires shown has a DALI operating device. In the right-hand and middle areas of the room are two groups. Here, use of groups 1...16 is advisable. In another area of the room, two more lights are installed, each of which is to be controlled separately. Here, use of single addressing is advisable.
- i** DALI operating devices can either be integrated only in single device addressing, or alternatively, in group addressing. It is not possible to control an operating device with both addressing types. Operating devices integrated in group control can no longer be addressed as a single device. The reverse case applies in the same manner.
- i** In particular, in large systems with multiple individual subscribers, the reaction time is slower than with pure group control, as addressing takes place individually and in sequence. If several DALI operating devices are to react identically to KNX commands (simultaneous switch-on or switch-off, identical brightness specifications), group addressing or alternatively scene control of these devices is preferable if possible.

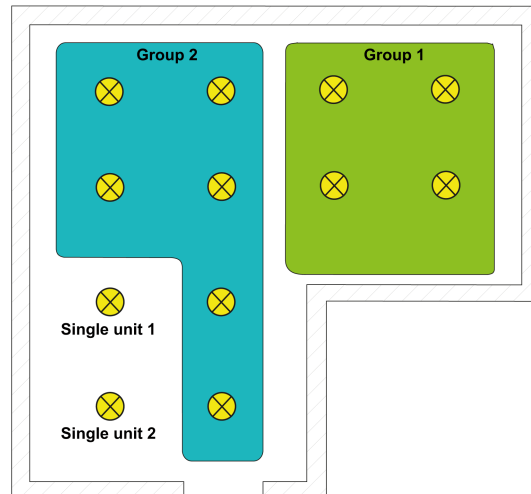

Figure 7: Example of group and single device control

- Group control 1...32 and device control 1...64:
This addressing type behaves in exactly the same way as the "Group control 1...16 and device control 1...64" addressing, with the difference that groups 17...32 are also available. Here too, groups 17...32 can be assigned only to up to five DALI operating devices. In this case too, as there are no DALI group addresses, DALI addressing takes place using the device short addresses, meaning that the operating devices are addressed, and thus contacted, individually.
- Device control 1...64:
This addressing type only allows control of up to 64 single devices. Group addressing is not possible. As with the other addressing types with device control, the addressing of the devices takes place individually using the device short addresses.
It is advisable to use this addressing type if all operating devices are to be controlled individually, for example, and group control is therefore not appropriate.

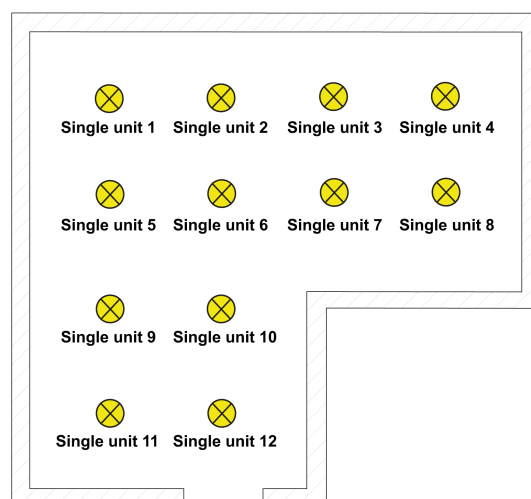

Figure 8: Example of single device control - All the DALI operating devices can be controlled individually

Multiple assignment of DALI operating devices to different groups

For special cases, it is possible to assign operating devices for group control to more than just one group. In the standard case, assignment of a DALI operating device is only possible in one device. This makes the device assignment clear, and the unique assignment means that there are no group overlaps and, as a result, no influencing of status values. If necessary, multiple group assignment can be enabled as an alternative. For this purpose, the checkbox "Allow multiple group assignment" must be selected in the commissioning dialogue of the DCA (this checkbox is deselected by default). This means that it is then possible to assign DALI operating devices to more than just one group during online commissioning.

- i** Multiple assignment of DALI operating devices to different single devices of the project design (device control) is not possible.

DALI operating devices can always be assigned to any group. However, we do not recommend assigning the operating devices to multiple groups on the DALI side. It is better to split the devices up into separate, non-overlapping groups and to create a link on the KNX side using the group addressing in the ETS.

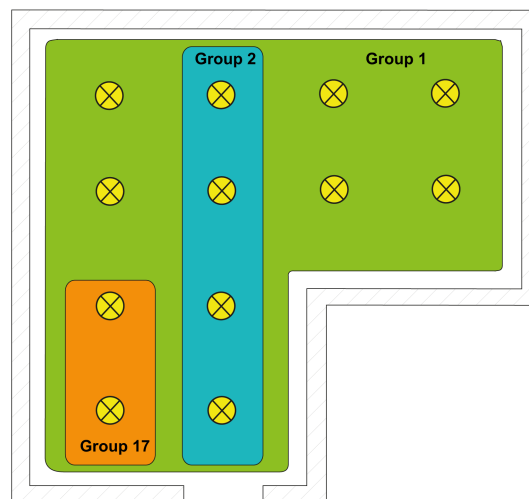

Figure 9: Example of multiple assignment of operating devices - Here: Group 1 overlaps with Group 2 and Group 17

DALI operating devices assigned to multiple groups always set themselves to the most recent status set using one of the assigned groups. In this case, feedback of the switching status, brightness value, colour temperature or colour of a group cannot always be clear. The following examples explain this behaviour:

Example 1: Group 1 is set to 10 % brightness. After this, group 2 is dimmed to the 20% brightness value. The lights of Group 2 assume the most recently recalled brightness value: 20 %. The feedback of Group 1 remains at 10 %, although some of the operating devices belonging to the group were set to 20 % brightness.

Example 2: Group 1 is switched on and sets itself to the brightness value 100 %. The status of group 2 is still internally set to 0% brightness (OFF) in the gateway. Now Group 2 is made brighter. The lights of Group 2 adopt the dimming behaviour (becoming brighter from minimum brightness), although these lights have already been switched on by Group 1.

- i** If DALI operating devices are assigned to multiple groups and these groups have been assigned to a shared scene, all operating devices will adjust to the brightness, colour temperature or colour value specified by the group with the highest number. Example: An electronic ballast was assigned to Groups 1 and 2. Both groups are assigned to Scene 1. When the scene is recalled, Group 1 is to set itself to 10 % and Group 2 to 20 % brightness. When Scene 1 is recalled, the electronic ballast is set to 20% brightness, because group 2 has the higher group number.

8.1.3 DALI device types

When assigning DALI operating devices to groups and single devices in the course of DALI commissioning with the DCA, the DALI device type is always checked automatically. Here, the device type transmitted by the operating devices is compared with the functional scope of the projected group and single devices. The DCA only establishes an assignment if compatible device types correspond to the scope of functions (e.g. scope of functions group = "Brightness + Colour RGB" -> compatible device type must be "DT8", colour type must correspond to "Colour Control"). This prevents functional errors after commissioning.

Scope of functions groups	Group type	Compatible DALI device types	Use
Brightness	DIM	all	only control the brightness
Brightness & colour temperature ³	TW	only DT8 with colour type "colour temperature (Tc)	Control of brightness and colour temperature
Brightness & colour RGB ³	RGB	Only DT8 with colour type "Colour Control (RGB-WAF)" ¹	Control the brightness and colour in the RGB colour space
Brightness & colour RGBW ³	RGBW	Only DT8 with colour type "Colour Control (RGB-WAF)" ²	Control brightness and colour in the RGBW colour space

Table 1: Configurable functional scope of groups

DALI device type Single device	Compatible DALI device types	Use
DT0 (fluorescent lamp)	only DT0	only control the brightness
DT2 (discharge lamp)	only DT2	only control the brightness
DT3 (LV halogen lamp)	only DT3	only control the brightness
DT4 (incandescent lamp)	only DT4	only control the brightness
DT6 (LED module)	only DT6	only control the brightness
DT7 (switchable only)	only DT7	only control of the switching state (DALI switching actuator)

DALI device type Single device	Compatible DALI device types	Use
DT8 (colour temperature) ³	only DT8 with colour type "colour temperature (Tc)	Control of brightness and colour temperature
DT8 (colour RGB) ³	Only DT8 with colour type "Colour Control (RGB-WAF)" ¹	Control the brightness and colour in the RGB colour space
DT8 (colour RGBW) ³	Only DT8 with colour type "Colour Control (RGB-WAF)" ²	Control brightness and colour in the RGBW colour space
Universal ⁴	all	only control the brightness

Table 2: Configurable range of functions for single devices

- i** 1: DALI operating devices of DT8 device type must correspond at least to the "Colour Control RGB" colour type. The extended DALI colour types "WAF" (White [W], Amber [A], Freecolour [F]) can be assigned, but these are not supported.
- i** 2: DALI operating devices of the DT8 device type must correspond at least to the "Colour Control RGBW" colour type. The extended DALI colour types "AF" (Amber [A], Freecolour [F]) can be assigned, but these are not supported.
- i** 3: The device types "DT8 (colour temperature)", "DT8 (RGB colour)" and "DT8 (RGBW colour)" can be configured only if the integration of DT8 operating devices is planned.
- i** 4: The DALI device type "Universal" can be configured only for single devices if the integration of DT8 operating devices is not intended.

With the "central control" addressing type, no commissioning with the DCA takes place and consequently also no checking of compatible device types. In this case, when installing the DALI system, the installation engineer or system integrator must ensure that only DALI operating devices are installed that correspond to the projected scope of functions and can perform the intended functions.

8.1.4 Parameters for DALI system and addressing types

DALI system... -> General

Addressing mode	<p>Central</p> <p>Groups 1...16</p> <p>Groups 1...32</p> <p>Groups 1...16 + devices 1...64</p> <p>Groups 1...32 + devices 1...64</p> <p>Devices 1...64</p>
-----------------	---

A DALI system can address a maximum of 64 operating devices, although the gateway itself does not count as an operating device. Up to six different addressing types allow the group-orientated and individually addressed control of DALI lights by means of KNX telegrams. Depending on the configuration, up to 32 independent groups are available for group addressing. For alternative control, they can be supplemented with 64 individually addressable device channels, if necessary.

Central: With master control, all the connected DALI components are controlled by a broadcast command. This means that there is no need to commission DALI, meaning that lighting systems with few functions can be started up quickly and easily (simplified configuration without DALI commissioning). With central addressing, some functions are not available (no error status, no automatic device replacement).

Groups 1...16: During DALI commissioning, the max. 64 DALI operating devices are assigned to any different groups of the gateway. For this any number of DALI operating devices can be assigned to each group (1...16). On the DALI side, addressing takes place using group addresses, which the gateway configures invisibly for the user and manages on its own. During DALI commissioning, the operating devices concerned are automatically programmed accordingly. Through the use of group addresses (multicast), the reaction time of the DALI subscribers in this type of addressing is short - particularly in large-scale systems.

Groups 1...32: With this addressing type too, the max. 64 DALI operating devices are assigned to different groups of the gateway during DALI commissioning. For this, any number of DALI operating devices can be assigned to groups 1...16. On the DALI side, addressing takes place using group addresses, meaning that the reaction time of the DALI subscribers in groups 1...16 is short. In contrast, only up to five DALI operating devices can be assigned to groups 17...32. Since there are no DALI group addresses for these groups, DALI addressing takes place using the device short addresses, which means that the operating devices are addressed, and thus contacted, individually. In particular, in large systems with multiple devices addressed by a short address, the reaction time is slower than with group addressing, because addressing takes place separately and in sequence.

Addressing type (continued)	<p>Central</p> <p>Groups 1...16</p> <p>Groups 1...32</p> <p>Groups 1...16 + devices 1...64</p> <p>Groups 1...32 + devices 1...64</p> <p>Devices 1...64</p>
-----------------------------	---

Groups 1...16 + devices 1...64: With this addressing type, the operating devices in groups 1...16 are controlled using DALI group addresses, as described above for group control. In addition, other DALI operating devices can be addressed individually as single devices. The addressing of these devices takes place individually using the device short addresses.

Groups 1...32 + devices 1...64: This addressing type behaves exactly like the addressing "groups 1...16 + devices 1...64", with the difference that the groups 17...32 are also available. Here too, groups 17...32 can be assigned only to up to five DALI operating devices. In this case too, as there are no DALI group addresses, DALI addressing takes place using the device short addresses, meaning that the operating devices are addressed, and thus contacted, individually.

Devices 1...64: This addressing type only allows the control of up to 64 single devices. DALI group addressing is not possible. As with the other addressing types with device control, the addressing of the devices takes place individually using the device short addresses. It is advisable to use this addressing type if all operating devices are to be controlled individually, for example, and group control is therefore not appropriate.

Integration of DALI DT8 control gears	Checkbox (yes/no)
	<p>The gateway supports the control of DALI operating devices of device types "DT8 - Tunable White" and "DT8 - Colour Control". This makes it possible to control the colour temperature and colour of a luminaire by means of suitable DALI operating devices and lamps.</p> <p>When assigning DALI operating devices to groups and single devices in the course of DALI commissioning with the DCA, the DALI device type is always checked automatically. Here, the device type transmitted by the operating devices is compared with the functional scope of the projected group and single devices. The DCA establishes an assignment only if compatible device types correspond to the scope of functions.</p> <p>Checkbox selected: DALI-DT8 operating devices can be integrated specifically. It is possible to individually control the brightness and furthermore the colour temperature and colour of DALI operating devices that support this range of functions.</p> <p>Checkbox deselected: It is not possible to specifically control the colour temperature and colour by means of suitable DALI-DT8 operating devices. All operating devices installed in the DALI system are controlled by the gateway exclusively in terms of brightness.</p>

DALI system... -> Configuration groups

Number of groups	1...16 1..32
<p>At this point, the number of DALI groups available in the DALI system can be configured.</p> <p>The sum of projected groups and single devices in a DALI system must not exceed 64! The application program indicates a project design error if the number of groups and single devices exceeds this limit. In this case, the number of groups or single devices must be reduced.</p> <p>This parameter is available only if the configured addressing type provides for group control. The number of available groups and consequently the value range of the parameter also depends on the selected addressing type.</p>	
Name	Group
<p>Here, the group can be assigned a unique name (e.g. "Office, window side 1"). The name is used for better orientation in the ETS. It is not programmed in the device.</p> <p>Special feature when using the ETS5: Due to a functional limitation, the ETS5 may show the preset designation of a group in English.</p>	
Scope of functions	<p>Brightness</p> <p>Brightness & colour temperature (DT8)</p> <p>Brightness & colour RGB (DT8)</p> <p>Brightness & colour RGBW (DT8)</p>
<p>When assigning DALI operating devices to groups in the course of DALI commissioning with the DCA, the DALI device type is always checked automatically. The device type transmitted by the operating devices is compared in the process with the functional scope configured here.</p> <p>Brightness: Only the brightness can be controlled. DT8-specific commands are not used. With the DCA, all DALI device types can be linked to the group during DALI commissioning.</p> <p>Brightness & colour temperature (DT8): It is possible to control the brightness and also the colour temperature. Only operating devices that support this range of functions can be assigned to the group with the DCA during DALI commissioning (only DT8 with "Colour Control (RGBWAF)" colour type). This setting is available only when integrating DT8 operating devices.</p> <p>Brightness & colour RGB (DT8): It is possible to control the brightness and also the colour in the "RGB" colour space. Only operating devices that support this range of functions can be assigned to the group with the DCA during DALI commissioning (only DT8 with "Colour Control (RGBWAF)" colour type). This setting is available only when integrating DT8 operating devices.</p> <p>Brightness & colour RGBW (DT8): It is possible to control the brightness and also the colour in the "RGBW" colour space. Only operating devices that support this range of functions can be assigned to the group with the DCA during DALI commissioning (only DT8 with "Colour Control (RGBWAF)" colour type). This setting is available only when integrating DT8 operating devices.</p>	

DALI system... -> Configuration single devices

Number of single devices	1...64
<p>At this point, the number of DALI groups available in the DALI system can be configured.</p> <p>The sum of projected groups and single devices in a DALI system must not exceed 64! The application program indicates a project design error if the number of groups and single devices exceeds this limit. In this case, the number of groups or single devices must be reduced.</p> <p>This parameter is available only if the configured addressing type provides for single device control.</p>	

Name	Electronic ballast
<p>At this point, a unique name (e. g. "kitchen light, left") can be assigned to the single device. The name is used for better orientation in the ETS. It is not programmed in the device.</p> <p>Special feature when using ETS5: Due to a functional limitation, the ETS5 may display the preset designation of a single device in English.</p>	

Device type	<p>DT0 (fluorescent lamp)</p> <p>DT2 (discharge lamp)</p> <p>DT2 (discharge lamp)</p> <p>DT3 (LV halogen lamp)</p> <p>DT4 (incandescent lamp)</p> <p>DT6 (LED module)</p> <p>DT7 (switchable only)</p> <p>DT8 (colour temperature)</p> <p>DT8 (colour RGB)</p> <p>DT8 (colour RGBW)</p> <p>Universal</p>
-------------	--

At this point, the functional scope provided by the projected single device is defined. When assigning DALI operating devices to single devices during DALI commissioning with the DCA, the DALI device type is always automatically checked. The device type transmitted by the operating devices is compared in the process with the functional scope configured here.

The device types "DT8 (colour temperature)", "DT8 (RGB colour)" and "DT8 (RGBW colour)" can be configured only if the integration of DT8 operating devices is intended.

The DALI device type "Universal" allows all DALI device types to be linked to the projected single device with the DCA during DALI commissioning. This setting can be configured only if the integration of DT8 operating devices is not intended.

Short address	1...64
<p>The device short addresses are assigned here in the parameter configuration of the single devices and can thus be influenced. Short addresses must be unique. This means that addresses may not appear multiple times in a DALI system. The application program checks the editing of short addresses and ensures their uniqueness.</p> <p>The presetting depends on the selected single device.</p>	

8.2 Operation and indication

8.2.1 Button operation and indication functions

The gateway offers manual operation to control the switching status and brightness of all programmed luminaire groups and single devices. The keypad with function buttons and status LEDs on the front of the device can be used to set the following operating modes. Manual operation is possible separately for DALI systems 1 and 2 with the 2-gang device variant.

- Bus mode: operation by push-button sensors or other KNX devices,
- Temporary manual operation mode: manual operation locally with keypad, automatic return to bus control,
- Permanent manual control: local manual control with keypad.

- i** The operating modes can be enabled or disabled by parameter settings in the ETS.
- i** In manual operation, the groups or single devices cannot be controlled via the KNX.
- i** Manual operation is possible only when the mains voltage supply to the gateway is switched on. In the delivery state of the DALI gateway, manual operation is enabled. In this unprogrammed state, all connected DALI operating devices of both DALI systems can be controlled using the broadcast function to enable fast function checking of the connected electronic ballasts (e.g. on the construction site).
- i** In manual operation mode, bus operation can be disabled via a telegram. Manual operation mode is terminated on activation of the disabling function.
- i** Only the switching state (ON/OFF) and the brightness value (dimming) can be controlled by manual operation. The colour temperature of a group or single device cannot be changed. In the case of colour-controllable DALI operating devices, the colour is set to the maximum colour value (RGB: #FFFFFF) and, if necessary, also to the maximum white value (#FF) during manual operation, but only if the current colour corresponds to the state "#000000" (black) and the optional white value corresponds to "#00". This ensures that manual brightness control by manual operation can be recognised by the user.

Controls and indicators for manual control

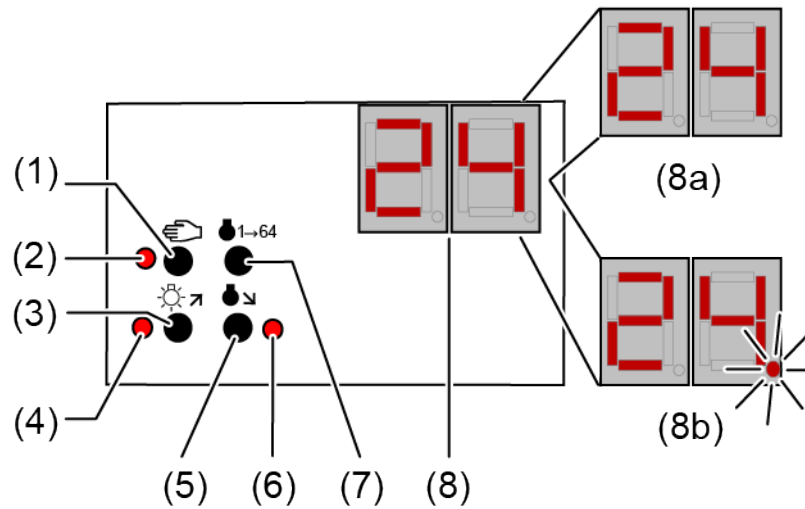

Figure 10: DALI gateway control panel, 1-gang

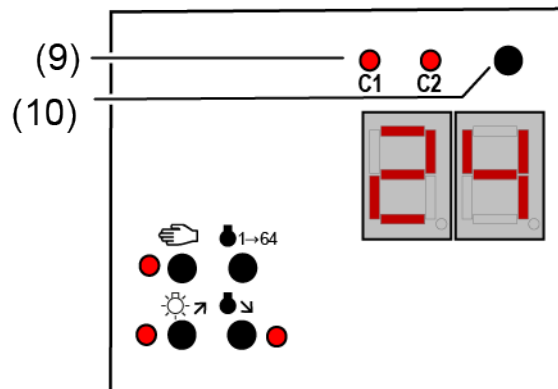

Figure 11: Extended DALI gateway control panel, 2-gang

- (1) Button Manual operation
- (2) LED On: continuous manual mode active
Flashing: temporary manual mode active
- (3) Button Short press (< 1 s): ON / long press (1...5 s): dims brighter.
- (4) LED LED ON in manual operation indicates a switched-on group/single device (brightness: 1...100 %).
- (5) Button Short press (< 1 s): OFF / long press (1...5 s): dims darker.
- (6) LED LED ON in manual operation indicates a switched-off group/single device (brightness: 0 %).
- (7) Button All DALI subscribers OFF (only in permanent manual operation).

- (8) Seven-segment display for indication of the number (1...16, 1...32) of a DALI group (8a) or the short address (1...64) of a single device (8b) selected by manual operation. In bus mode, there is no indication of the group number or short address. In addition, to display additional information:
- -: signals DALI initialisation phase, delay after ETS programming operation / mains voltage return or temporary status indication.
 - bc**: indication during manual operation in broadcast mode (unprogrammed state, central control).
 - Er**: indication of an impermissible external voltage at the DALI device connection terminals (e.g. mains voltage connected). DALI gateway without function. The gateway is not ready for operation again until the error has been eliminated and initialisation has been performed again (mains voltage return).
 - db**: a high telegram load has been detected in the DALI system signalled by the LED (9). This high load can lead to disturbed operation (noticeable delays, telegram loss).
 - LE**: signals automatic device replacement.
 - E**: signals an error during automatic device replacement.
- (9) LED of the active DALI system for manual operation (only with 2-gang device variant).
Permanently ON in manual mode or briefly ON (5 s) after pressing the changeover key in ongoing normal mode.
- (10) Change-over button for DALI systems 1 and 2 (only with "2fold" device variant)

If (8) **bc** (broadcast operation) is indicated, all devices of a DALI system are controlled simultaneously. This is done in the following operating conditions:

- The device is not programmed (delivery state),
- In the KNX configuration, central control is set for the selected DALI system,
- In bus mode of manual operation, broadcast control is possible in addition to the control of groups and single devices.

With the 2-gang device variant, the change-over button (10) can be used to switch between operation of DALI systems 1 and 2. This is possible either while the device is in operation or during active temporary or permanent manual operation. Only the selected DALI system is ever operated via the keypad of the manual control. The LEDs (9) signal the DALI system effective for manual operation.

- i** The change-over button (10) has no function during temporary status indication.
- i** The LEDs (9) light up for the duration of the initialisation phase of the two DALI systems (after an ETS programming operation or after the mains voltage returns). The initialisation phase of the two systems may be of different length.

Switching on temporary manual operation mode

Manual operation is configured in the ETS and not disabled.

- Press the  (1) button briefly (< 1 s).

The LED  (2) flashes. With the "2-gang" device variant, the LED (9) of the DALI system selected for manual operation is lit up.

The first group number, short address or **bc** is indicated (8).

After five seconds without button actuation or after selecting the last DALI group or the last single device and pressing the button  again, the device returns to bus mode.

Switching on/off the permanent manual mode

Manual operation is configured in the ETS and not disabled.

- Press the  (1) button for at least 5 seconds.

The LED  (2) lights up. With the "2-gang" device variant, the LED (9) of the DALI system selected for manual operation is lit up.





The first group number, short address or **bc** is indicated (8). Permanent manual operation is switched on.

- or in case of repeated actuation for at least 5 seconds -

LED  (2) is off, indication (8) is off, bus mode is switched on.

Operating DALI devices

The device is in temporary or permanent manual operation mode.

- Press the  button (1) briefly as many times as necessary until the desired DALI group number or short address is indicated (8).
- Operate output with  (3) button or  (5) button.
Short: switch on/off.
Long: dim brighter/darker.
Release: Stop dimming.
The LEDs  (4) and  (6) indicate the status.

The numbers of the available DALI groups (8a) are indicated (8) first, and then the short addresses of the single devices (8b). If configured, **bc** for Broadcast appears at the beginning.

-  After a device reset (mains voltage return, ETS programming operation), the switching state "OFF" may be signalled initially, regardless of the actual switching states of the DALI operating devices. In this case, the switching status is displayed correctly only after manual operation. This must be observed in particular in broadcast mode when individual operating devices of the DALI system are switched on before manual operation is carried out. The status LEDs then show the command of the last broadcast manual operation.

Switch off all DALI devices





The device is in permanent manual operation mode.

- Press the _{1→64} button (7).

Disabling/enabling individual DALI devices or groups

The device is in permanent manual operation mode and the lock is released.

Press  (1) button briefly as many times as necessary until the desired DALI number is indicated (8).

- Press the buttons   (3) and   (5) simultaneously for at least 5 seconds. The selected DALI number flashes on the display (8).

DALI device or group is blocked.

- or in case of repeated actuation -

The display (8) no longer flashes.

DALI device or group is enabled.

- Activate bus mode (see section Switching the permanent manual mode on/off).

DALI devices blocked via manual operation can be operated in manual mode.

Replacing a DALI device

After starting the automatic device replacement, the DALI gateway is able to check a DALI system of the previously operated DALI operating devices for completeness. If, for example, a defective electronic ballast was removed by an installation engineer and replaced by a new one, the DALI gateway is able to program the new electronic ballast with the programming data of the failed electronic ballast. This makes it possible to replace a failed DALI operating device by a simple operation on the device and without any modification work in the ETS.

-  When using the automatic device replacement, only operating devices of the same DALI type can be interchanged! If operating devices of another type are to be used, full DALI commissioning must be carried out using the ETS.

Prerequisite: Only one DALI operating device per DALI system may fail and be replaced!



Prerequisite: The DALI gateway was programmed at least once before by the ETS.

Prerequisite: Automatic device replacement must be enabled in the ETS.

Prerequisite: It must be ensured that the bus and mains voltage remain switched on without interruption (also at all DALI operating devices) during the process.

Prerequisite: It is important that the DALI system has previously been fully commissioned by DALI commissioning.

Prerequisite: The device must be in bus operation (no manual operation active).

- Press the  and  buttons simultaneously for approx. 10 seconds.

Automatic device replacement is activated. The length of the operation is dependent on the number of DALI operating devices in the system. When replacing the device, the 7-segment display signals **LE** (Learn). The display goes out after a successful replacement operation.

The automatic device replacement updates the configuration data (long address) of the replaced DALI operating device initially only in the gateway. To ensure that the change of the DALI configuration is permanently adopted in the ETS configuration, a DALI device search should be carried out again in the ETS (DCA) after executing one or more operations of the automatic device replacement. Through this, although no new operating devices are found, the DCA compares the DALI project planning data between gateway and ETS and saves the change in the ETS project. Only then may new programming operations of the application program be carried out.

- i** If the application program is programmed with the ETS after an automatic device replacement without a subsequent new DALI device search in the DCA, the changes brought about by the device replacement will be lost. In this case, the DCA will display newly found operating devices that are actually not new in future device searches.
- i** During device replacement, all the other functions of the DALI gateway are stopped. When replacing the device, the gateway tracks all the received bus states and evaluates the most recently tracked values (switching, dimming, values, scenes, central function, forced position function, disabling function) normally at the end of the automatic device replacement. An active forced position or disabling function is interrupted by device replacement and reactivated at the end of the replacement operation, if the functions have not been deactivated via the bus in the interim. The behaviour as at the beginning of the forced position or disabling function is not executed again.
- i** Ensure that only one DALI operating device is replaced in the manner described. If multiple electronic ballasts fail (possibly no mains voltage is switched on) and have been replaced, then the electronic ballasts cannot be identified clearly by the gateway and not configured automatically. In this case, the DALI must be commissioned by the ETS again.
- i** If an error occurred when replacing the device, the 7-segment display signals **E** (Error) for three seconds. Perform the operation again, taking the mentioned conditions and information into account. This signalling also takes place if automatic device replacement was activated, without having replaced a DALI operating device previously.
- i** With the "2-gang" device variant, automatic device replacement can be carried out separately in the DALI systems. The systems do not influence each other.

8.2.2 ETS configuration

8.2.2.1 Manual operation

The gateway has a manual control to manually control the configured groups and single devices or for broadcast control. The keypad with function buttons, status LEDs and 7-segment display on the front of the device can be used to set the following operating modes of the device...

- Bus control: operation from touch sensors or other bus devices,
- Temporary manual control: manual control locally with keypad, automatic return to bus control,
- Permanent manual control: local manual control with keypad.

Manual operation is possible only when the mains voltage supply to the gateway is switched on. In the delivery state of the gateway, manual operation is enabled. In this unprogrammed state, all connected DALI operating devices of both DALI systems can be controlled using the broadcast function to enable fast function checking of the connected electronic ballasts (e.g. on the construction site).

After initial commissioning of the gateway via the ETS, manual operation can be enabled or disabled separately for various states of operation. Manual operation, for instance, can be deactivated during bus operation (bus voltage applied). It is also possible to deactivate manual operation in the event of a bus voltage failure.

- i** Only the switching state (ON/OFF) and the brightness value (dimming) can be controlled by manual operation. The colour temperature of a group or single device cannot be changed. In the case of colour-controllable DALI operating devices, the colour is set to the maximum colour value (RGB: #FFFFFF) and, if necessary, also to the maximum white value (#FF) during manual operation, but only if the current colour corresponds to the state "#000000" (black) and the optional white value corresponds to "#00". This ensures that manual brightness control by manual operation can be recognised by the user.

Enabling the manual control mode

Manual operation is enabled for the different states of operation by means of the parameters "Manual control in case of bus voltage failure" and "Manual control during bus operation".

- Activate the parameter "Manual control during bus operation".
Manual control is then basically enabled when the bus voltage is on. The DALI groups and single devices of the gateway can be controlled via the bus or by manual operation. This setting corresponds to the setting of the actuator as delivered.
- Deactivate the parameter "Manual control during bus operation".
Manual control is completely disabled when the bus voltage is on. In this configuration, the DALI groups and the single devices of the gateway can be controlled only via KNX.

- Activate the parameter "Manual control in case of bus voltage failure".
Manual control is then basically enabled when the bus voltage is off. This setting corresponds to the setting of the actuator as delivered.
 - Deactivate the parameter "Manual control in case of bus voltage failure".
Manual control is completely disabled when the bus voltage is off. Since bus operation is also not possible in this state, the DALI operating devices can no longer be controlled.
- i** Manual control is only possible when the mains voltage is on. The parameter "On bus voltage return" defines whether temporary or permanent manual operation is automatically terminated as soon as the bus voltage is switched on.

Presetting the behaviour at the beginning and at the end of manual operation

Manual operation distinguishes between the temporary and permanent manual operation modes. The behaviour is different depending on these operating modes, especially at the end of manual operation. It should be noted that bus operation, - i. e. control of the DALI groups and single devices by direct operation (switching/dimming/value/scenes/central) or by the disabling or forced position functions - is always disabled during activated manual operation. This means that the manual control mode has the highest priority.

Behaviour at the beginning of manual operation:

The behaviour at the beginning of manual operation does not differ for temporary and permanent manual operation modes. During activation of the manual operation, the brightness statuses of the DALI groups and single devices remain unchanged.

- i** "Flashing during disabling function" feature: The flashing of a disabling function is interrupted at the beginning of a manual operation. The brightness remains at the most recently set flash state ("ON" or "OFF"). The switching status is indicated as "ON".

Behaviour at the end of manual operation:

The behaviour at the end of manual operation is different for temporary and permanent manual operation modes. Temporary manual operation mode is automatically switched off as soon as the last group or single device has been selected and the selection button  pressed once more. During deactivation of the temporary manual operation mode, the gateway returns to 'normal' bus operation and does not change the brightness states selected by manual control. If a forced position or disabling function was activated via KNX before or during manual operation, the gateway executes these functions of higher priority again for the groups and single devices concerned.

The permanent manual operation mode is shut off when the selection button  is pressed for more than 5 seconds. Depending on the configuration of the gateway in the ETS, the groups are set to the state last set by manual operation or to the state internally tracked (direct bus operation, disabling function, forced position) when permanent manual operation is switched off. The parameter "At end of permanent manual operation" defines the corresponding reaction.

- Set the parameter "At end of permanent manual operation" to "no change".
All telegrams received during the active permanent manual operation for direct bus operation (switching, dimming, value, central, scenes) are rejected. After the end of the permanent manual control mode, the current brightness state of all the groups and single devices remains unchanged. If, however, a forced position or disabling function was activated before or during manual operation, the gateway executes these functions of higher priority again for the groups concerned.
- Set the parameter "At end of permanent manual operation" to "track outputs".
During active permanent manual operation, all incoming telegrams are tracked internally. At the end of manual operation, the groups and single devices are set to the last tracked brightness states. If a forced position or disabling function was activated before or during manual operation, the gateway executes these functions of higher priority again for the groups and single devices concerned.
- i** When tracking enabling functions or forced positions: If a disabling function was activated via the KNX before or during temporary or permanent manual operation, the gateway always executes these higher-priority functions for the affected groups and single devices at the end of the manual operation (locking of bus operation). Only in the setting "At end of permanent manual operation = Track outputs" does the gateway perform the behaviour at the beginning of the disabling function again. Bus operation by switching, dimming, value, scene, central is then disabled.
- i** The behaviour at the end of the permanent manual control when the bus voltage is off (only manual control) is permanently set to "no change".
- i** The operating processes triggered during manual operation are transmitted to the KNX by means of the status objects, provided the bus voltage is switched on.
- i** Activated manual operation is always exited in the event of an ETS programming operation. If manual operation is possible in the event of a bus voltage failure, the parameter "On bus voltage return" decides whether manual operation is terminated or not when the bus voltage is switched on again. In both cases, when manual operation is ended, the specified behaviour at the end of the manual operation is not executed. Instead, the gateway executes the behaviour configured for the groups and single devices after an ETS programming operation or when the bus/mains voltage returns.

Presetting a manual control disable

Manual operation can be disabled separately via the KNX, even if it is already active. If the disabling function is enabled, the gateway immediately terminates an activated manual operation and locks the function buttons on the front of the device as soon as a disabling telegram is received. The telegram polarity of the disabling object can be configured.

The manual control mode during bus operation must be enabled.

- Activate the parameter "Disabling function" on the "Manual operation" parameter page.
The disabling function of manual operation is enabled and the disabling object becomes visible.
- Select the desired telegram polarity in the parameter "Object polarity".
- i** In the polarity "1 = enabled / 0 = disabled", the disabling function is immediately active on return of bus/mains voltage or after an ETS programming operation (object value = "0"). To activate the manual control in this case, an enable telegram "1" must first be sent to the disabling object.
- i** In case of bus voltage failure, disabling via the disabling object is always inactive (depending on parameterization, the manual control is then either enabled or completely disabled). After the bus voltage returns, a disabled state that was active beforehand is always inactive when the polarity of the disabling object is non-inverted.
- i** In the event of failure of the supply voltage (mains voltage failure), disabling is deactivated via the disabling object.
- i** If an active manual operation is terminated by disabling, the actuator also transmits a "Manual operation inactive" status message to the KNX if the status message is enabled.
- i** The "Automatic device replacement" function is not influenced by the disabling function of the manual operation.

Presetting the status message function for manual operation

The gateway can transmit a status message to the KNX by means of a separate object when the manual operation is activated or deactivated. The status telegram can only be transmitted when the bus voltage is switched on. The function of the status message can be configured.

The manual control mode during bus operation must be enabled.

- Activate the parameter "Status object" on the "Manual operation" parameter page.
The status messaging function of manual operation is enabled and the status object is visible.
- In the "Function" parameter, define whether the status telegram always becomes "1" whenever manual operation is activated or only if permanent manual operation is activated.
- i** The status object is always "0" when the manual control mode is deactivated.
- i** The status ("0") is always actively transmitted to the KNX after the mains voltage returns, provided the bus voltage is available. The status is actively transmitted to the KNX only after the bus voltage returns with an existing

mains voltage supply if the manual operation was activated during the bus failure or is terminated by the bus voltage return. In these cases, the status telegram is transmitted without delay.

- i** When an active manual operation is terminated by disabling, the actuator also transmits a "Manual control inactive" status message to the KNX.

Setting disabling of the bus control

Individual groups and single devices can be disabled locally so that the DALI operating devices concerned can no longer be controlled via the KNX. Such disabling of the bus operation is initiated by local operation in permanent manual operation and is indicated by the group or single device number flashing on the 7-segment display. The disabled groups and single devices can then only be activated in permanent manual operation.

The manual control mode during bus operation must be enabled.

- Activate the parameter "Bus control of individual groups or single devices can be disabled" on the parameter page "Manual operation".

The function for disabling the bus control is enabled and can be activated locally. Alternatively, deactivating the parameter prevents disabling of the bus control from being activated in permanent manual operation mode.

- i** The disabling initiated locally has the highest priority. Thus all other functions of the gateway that can be activated via the KNX (e.g. forced position or disabling function) are overridden. Depending on the configuration of the gateway in the ETS, the groups and single devices are set to the state last adjusted by the manual operation or to the state internally tracked (direct operation, forced position, disabling) when permanent manual operation is disabled and subsequently switched off.
- i** Any disabling of the bus control activated locally is not reset in case of bus voltage failure or return. A failure of the supply voltage (mains voltage failure) or an ETS programming operation always deactivates disabling of the bus control.

DALI device replacement

After starting the automatic device replacement, the DALI gateway is able to check a DALI system for the completeness of the previously operated DALI operating devices. If, for example, a defective DALI electronic ballast was removed by an installation engineer and replaced by a new one, the DALI gateway is able to program the new electronic ballast with the programming data of the failed electronic ballast. This makes it possible to replace a failed DALI operating device by a simple operation on the device and without any configuration work in the ETS.

- i** When using the automatic device replacement, only operating devices of the same DALI type can be interchanged! If operating devices of another type are to be replaced, a complete DALI commissioning must be carried out using the ETS plug-in.

Activation of the automatic device replacement and the steps required to perform the replacement operation are described in detail in the "Operation" chapter of this documentation . The section below documents the ETS configuration of this function.

Setting enabling for DALI device replacement

In the ETS configuration, it is possible to specify whether or not an automatic device replacement can be executed through local control on the DALI gateway.

- Set the parameter "Enable DALI device replacement through manual operation ?" on the parameter page "General" to "yes".
Automatic DALI device replacement can be initiated and executed by local operation on the DALI gateway.
- Set the parameter "Enable DALI device replacement through manual operation ?" to "no".
Automatic DALI device replacement is not possible. The operating function is disabled locally.
- i** During automatic device replacement, all the other functions of the DALI gateway are stopped. During device replacement, the gateway tracks all the received bus states and evaluates the most recently tracked values (switching, dimming, brightness value, scenes, effects, central function, emergency operation, forced position, disabling function) normally at the end of automatic device replacement. Active emergency operation or an active forced position or disabling function is interrupted by device replacement and reactivated at the end of the replacement operation if the functions have not been deactivated in the meantime. The behaviour as at the beginning of a forced position or disabling function is not executed again.
- i** Automatic device replacement can also be executed when manual operation is disabled.

8.2.2.2 Status indication

The status display is either exclusively a normal display or can be supplemented by a temporary indication function. With a temporary status display, the 7-segment display always shows "--". DALI group numbers or short addresses are not indicated in the process.

- Normal indication:
The parameter "Indicate status temporarily" on the "Status indication" parameter page is deactivated. In this case, the 7-segment display only shows the number of the selected DALI group and the short address of the selected single device if a manual operation is active. In addition, the special operating states mentioned in the introduction are signalled. In normal operation, the indication remains switched off.
- Temporary status indication:
The parameter "Indicate status temporarily" on the "Status indication" parameter page is activated. During temporary indication, the status indication "--"

is activated by pressing the "Manual operation" button. The display length is set in the ETS.

If manual operation is enabled in the ETS, pressing the "Manual operation" button also activates the temporary or permanent manual operation mode. The 7-segment display always remains active during manual operation. At the end of manual operation mode, the display length of the temporary status indication is restarted. The indication "--" goes out after the configured time has elapsed.

If manual operation is not enabled in the ETS, the 7-segment display only shows "--" when the "Manual operation" button is pressed in accordance with the indication duration.

If the parameter "Control via object" is activated, the "Temporary status indication" communication object is available in the ETS. This object is bidirectional and can firstly signal the status of the temporary status indication, and secondly, activate the status display. If a temporary status indication has been activated by pressing the "Manual operation" button, the object transmits the value "ON". If the object receives a telegram with the value "OFF" or "ON", the 7-segment display shows "--" in accordance with the indication duration. Manual operation is not activated in this case.

By linking the "Temporary status indication" objects between the gateway and other actuators using a common group address, the indication functions of the 7-segment display and status LED can be synchronized with one another. It is thus possible to activate the status indications of all devices in a control cabinet at the same time if manual operation is triggered on only one gateway or actuator - e.g. for service or maintenance purposes.

In addition, the "Temporary status indication" object could be controlled, for example, by a magnetic contact connected to the KNX, so that the status indications of all devices are activated by opening the control cabinet door. If the door is closed, the status indications for energy saving remain switched off.

- i** During a running display length, the "Temporary status indication" object does not transmit any new telegrams if the "Manual operation" button is pressed again.
- i** The change-over button of the manual control used to switch over the DALI systems 1 and 2 has no function during temporary status indication.

8.2.3 Parameters for operation and indication

Manual operation

Manual control during bus operation	Checkbox (yes/no)
Whether the manual operation is to be possible or deactivated during bus operation (bus voltage on) can be configured here.	
Manual control in case of bus voltage failure	Checkbox (yes/no)
Whether the manual operation is to be possible or deactivated in the event of a bus voltage failure (bus voltage switched off) can be configured here.	
Disabling function	Checkbox (yes/no)
Manual operation can be disabled via the KNX, even if it is already active. For this purpose, the disabling object can be enabled here. This parameter is only visible if manual control is enabled during bus operation.	
Object polarity	0 = enabled / 1 = disabled 1 = enabled / 0 = disabled
This parameter sets the polarity of the disabling object. This parameter is only visible if the disabling function is enabled.	
Status object	Checkbox (yes/no)
The gateway can transmit a status message to the KNX by means of a separate object when the manual operation is activated or deactivated. This parameter is only visible if manual control is enabled during bus operation.	
Function	0 = inactive / 1 = manual operation active 0 = inactive / 1 = permanent manual operation active
This parameter defines the information contained in the status object. The object is always "OFF" when manual operation is deactivated. 0 = inactive / 1 = manual operation active: The object is "ON" when manual operation is active (temporary or permanent). 0 = inactive / 1 = permanent manual operation active: The object is only "ON" when permanent manual operation is active. This parameter is only visible if the status function is enabled.	

At end of permanent manual operation	No change Output tracking
<p>The behaviour of the gateway at the end of permanent manual control depends on this parameter. This parameter is only visible if manual control is enabled during bus operation.</p> <p>No change: all telegrams received during an active permanent manual control mode for direct operation (switching, dimming, brightness value, scenes) will be rejected. After ending the permanent manual operation, the states of all DALI groups and single devices that were active last in manual operation remain unchanged. If, however, a forced position or disabling function was activated via the KNX before or during the manual operation, the gateway executes these functions of higher priority for the groups and single devices concerned.</p> <p>Track outputs: during active permanent manual operation, all incoming telegrams and state changes are tracked internally. At the end of manual operation, the DALI groups and single devices are set to the last tracked brightness states. If a forced position or disabling function was activated via KNX before or during manual operation, the gateway executes these functions of higher priority again for the groups and single devices concerned.</p>	
On bus voltage return	exit manual operation do not exit manual operation
<p>This parameter defines whether a temporary or permanent manual operation is automatically terminated as soon as the bus voltage is switched on. It can be set only if the manual operation is active during bus operation.</p>	
Bus control of individual groups or single devices can be disabled	Checkbox (yes/no)
<p>Individual groups and single devices can be disabled locally during a permanent manual operation so that the disabled channels can no longer be controlled via the KNX. Disabling via manual operation is only permitted if this parameter is activated.</p> <p>This parameter is only visible if manual control is enabled during bus operation.</p>	
Enable broadcast control	Checkbox (yes/no)
<p>If necessary, the separate control of the groups and single devices by manual operation can be supplemented by broadcast control. If this parameter is activated, all operating devices connected to a DALI system can be switched or dimmed simultaneously. In this case, the selection "bc" is to be selected on the 7-segment display.</p> <p>If a DALI system is configured to "central control" for the "addressing type", the DALI devices are always controlled by a broadcast command. The parameter is permanently activated, provided all DALI systems available in the present device variant are set to central control.</p> <p>This parameter is visible only if the manual control is enabled for bus operation or in the event of a bus voltage failure.</p>	

Automatic device replacement enables DALI system 1	Checkbox (yes/no)
<p>After starting the automatic device replacement, the gateway is able to check a DALI system for completeness integrated in the system by a manual operation on the device. The DALI gateway detects individual replaced electronic ballasts and can program these devices with the appropriate programming data. The automatic device replacement for the DALI system 1 can be initiated by the manual operation on site at the device only if this parameter is activated. If the parameter is deactivated, a manual operation for device replacement will produce no reaction.</p> <p>If a DALI system is configured to "central control" with the "addressing type", it is generally not necessary to carry out automatic device replacement because no device addressing takes place in the DALI system. The parameter is then permanently deactivated.</p> <p>This parameter is visible only if the manual control is enabled for bus operation or in the event of a bus voltage failure.</p>	
Automatic device replacement enables DALI system 2	Checkbox (yes/no)
<p>After starting the automatic device replacement, the gateway is able to check a DALI system for completeness integrated in the system by a manual operation on the device. The DALI gateway detects individual replaced electronic ballasts and can program these devices with the appropriate programming data. The automatic device replacement for the DALI system 2 can be initiated by the manual operation on site at the device only if this parameter is activated. If the parameter is deactivated, a manual operation for device replacement will produce no reaction.</p> <p>If a DALI system is configured to "central control" with the "addressing type", it is generally not necessary to carry out automatic device replacement because no device addressing takes place in the DALI system. The parameter is then permanently deactivated.</p> <p>This parameter is visible only if the manual control is enabled for bus operation or in the event of a bus voltage failure.</p>	

Status indication

Indicating status temporarily	Checkbox (yes/no)
<p>The gateway has a 7-segment display on the front of the device that shows the number of the selected group and the short address of the selected single device during active manual operation. In addition, further operating states of the device are signaled by the 7-segment display (broadcast mode, DALI initialisation, automatic device replacement, DALI system voltage error). The 7-segment display is switched off in normal operation of the gateway.</p> <p>Parameter deactivated: Normal indication is active. In this case, the 7-segment display only shows the number of the selected DALI group and the short address of the selected single device if a manual operation is active. In addition, the special operating states mentioned in the introduction are signalled. In normal operation, the indication remains switched off.</p> <p>Parameter activated: Temporary status indication is activated. In this case, the status indication "--" is activated by pressing the "Manual operation" button. The display length is set in the ETS. If manual operation is enabled in the ETS, pressing the "Manual operation" button also activates the temporary or permanent manual operation mode. The 7-segment display always remains active during manual operation. At the end of manual operation mode, the display length of the temporary status indication is restarted. The indication "--" goes out after the configured time has elapsed.</p>	
Display length	6 ... 10 ... 255 s
<p>This parameter defines the display length if the temporary status indication is activated.</p>	
Control via object	Checkbox (yes/no)
<p>If the parameter "Control via object" is activated, the "Temporary status indication" communication object is available in the ETS. This object is bidirectional and can firstly signal the status of the temporary status indication, and secondly, activate the status display. If a temporary status indication has been activated by pressing the "Manual operation" button, the object transmits the value "ON". If the object receives a telegram with the value "OFF" or "ON", the status LEDs indicate the status of the outputs according to the display length. Manual operation is not activated in this case.</p>	

8.2.4 Objects for operation and indication

Function	Name	Type	DPT	Flag
Disabling	Manual operation - Input	1-bit	1.003	C, (R), W, -, A
1-bit object for disabling the manual operation on the device. The polarity can be configured.				
Function	Name	Type	DPT	Flag
Status	Manual operation - Output	1-bit	1.002	C, R, -, T, A
1-bit object for transmission of the manual operation status. The object is "OFF" when manual operation is deactivated (bus control). The object is "ON" when manual operation is activated. You can configure whether temporary or permanent manual operation will be indicated as status information or not.				
Function	Name	Type	DPT	Flag
Temporary status indication	Manual operation - Input/Output	1-bit	1.017	C, (R), W, T, A
1-bit object to signal and activate the temporary status indication. This object is bidirectional and can firstly signal the status of the temporary status indication, and secondly, activate the status display. If a temporary status indication has been activated by pressing the "Manual operation" button, the object transmits the value "ON". If the object receives a telegram with the value "OFF" or "ON", the status LEDs indicate the status of the outputs according to the display length. Manual operation is not activated in this case.				
The object is visible only if the temporary status indication is activated with control by means of the object.				

8.3 Priorities

The gateway distinguishes between different functions that can have an effect on a DALI group. In order to prevent conflicting output states, each available function has a certain priority. The function with the higher priority overrides the one with the lower priority. Functions that are on the same priority level influence each other.

The priority of the scene function over the disabling or forced position functions of a group or a single device can be configured. Thus, it is possible for a scene recall to override a disabling or forced position function. Alternatively, a scene can have a lower priority, which means that disabling functions or forced positions cannot be overridden by a scene recall. This results in different priority orders.

Priority order "scenes of lower priority than enabling function or forced position":

- 1st priority: manual control (highest priority)
- 2nd priority: forced position function or disabling function
- 3rd priority: normal operation / direct bus operation. These rules include...
 - Switching
 - Dimming
 - Brightness value
 - Colour temperature value
 - Colour values
 - Scenes
 - Central functions
 - Staircase function
 - HCL/CTM matrices
 - Colour wheel sequence that is more automatic
 - Automatic brightness cycle

Priority order "scenes of higher priority than enabling function or forced position":

- 1st priority: manual control (highest priority)
- 2nd priority: scenes
- 3rd priority: forced position function or disabling function
- 4th priority: normal operation / direct bus operation. These rules include...
 - Switching
 - Dimming
 - Brightness value
 - Colour temperature value
 - Colour values
 - Central functions

- Staircase function
- HCL/CTM matrices
- Colour wheel sequence that is more automatic
- Automatic brightness cycle

- i** With priority order "scenes of higher priority than enabling function or forced position": a scene recall does not statically lock subordinate functions of a group or single device. The higher priority solely specifies that the scene brightness value is set at the moment of the scene recall and the previously specified brightness value is overridden. After recalling a scene, it is possible that the scene brightness value will be changed by other functions of the gateway (e.g. on terminating an additional function or by switching or dimming).
- i** When tracking disabling functions or forced positions: If a forced position or a disabling function was activated via the KNX before or during temporary or permanent manual operation, the gateway always executes these higher-priority functions for the affected groups and single devices at the end of manual operation, but without re-executing the behaviour at the beginning of these functions. The brightness then always remains in the state of manual operation. Bus operation by switching, dimming, value, scene, central is disabled.

8.4 DALI communication

The DALI telegram rate limit can optionally be activated. Firstly, it is then possible to extend the period of time between DALI telegrams. Secondly, the initialisation behaviour of the gateway can be influenced. By using the DALI telegram rate limit, it is possible to adapt the communication behaviour of the gateway to problematic or non-DALI-conformant operating devices to a great extent.

The DALI telegram rate limitation is activated and configured separately for the DALI systems on the parameter page "DALI System... -> General".

Delay time after mains voltage return

After the mains voltage supply is switched on, DALI operating devices usually require different lengths of time to initialise themselves and thus to react to commands of the gateway, depending on their type. To ensure that no commands of the gateway to the operating devices are lost after mains voltage return - because they are still initialising - it is possible to activate a delay as an option. This delay is defined by the "Delay after mains voltage return" parameter, which is available on the parameter page "DALI System... -> General" with activated DALI telegram rate limitation, defined within the range of 1...30 seconds.

The delay time after the mains voltage returns delays the start of the application of the DALI gateway after the mains voltage supply is switched on as well as after an ETS programming operation and thus delays the execution of the configured behaviour after the bus voltage returns and all other automatic reactions (e.g. status telegrams) after a device reset. No DALI telegrams are transmitted by the gateway in this state. "- -" is displayed on the 7-segment display on the front panel of the device in order to signal that the device is not yet ready for operation.

KNX communication is also possible during the delay time. This allows groups and single devices as well as scenes to be controlled and commands specified. However, these are only executed once the delay time on the DALI page has elapsed. Only the last command related to a group, a single device or a scene is ever executed!

- i** If KNX telegrams for groups or single devices are received during the initialisation of the gateway, the device will execute the command most recently specified and not the configured behaviour after the bus voltage returns!
- i** The delay time after the mains voltage returns is not required if the initialisation time of the DALI operating devices is shorter than that of the gateway. In this case, the parameter should be set to the smallest value "1" or the DALI telegram rate limitation should be deactivated. If the operating devices initialise more quickly than the gateway, they will activate the programmed "power-on level" before the gateway transmits other brightness commands. After mains voltage return, this allows the observation of short-time changes to the brightness states in the DALI system.

- i** Should only the mains voltage supply of the gateway fail, the operating devices will set themselves to the "System Failure Level". After the mains voltage supply returns, the gateway - once the delay has elapsed - then transmits commands to the DALI page in accordance with the configured behaviour ("Behaviour after bus voltage return") or the last KNX specification.

Time delay between two DALI telegrams

According to the valid DALI standard IEC 62386 ed. 2, pauses of at least 13.5 ms must be maintained between the transmissions of individual DALI commands to the operating devices. Optionally, to reduce the telegram load for the DALI operating devices, and thus reduce the likelihood of errors on the part of some electronic ballasts, it is possible to increase the pause time between commands of the DALI gateway to the operation device. This results in a telegram rate limitation, which can be adapted separately by the parameter "Minimum time delay between two DALI commands" on the parameter page "DALI system... -> General". For this parameter to be visible, the DALI telegram rate limitation must be activated on the same parameter page.

Extending the pause time between the DALI commands gives the operating devices more time to react to the commands of the gateway. However, this also delays the reaction time of the overall DALI system when controlled by KNX telegrams and also during DALI commissioning or a DALI test! Particularly long delay times should therefore be avoided as far as possible.

- i** The approved pause time between commands from the gateway to the DALI operating devices and the matching response is within a range of 5.5...10.5 ms. This time period is required by the operating devices and cannot be influenced by the gateway.

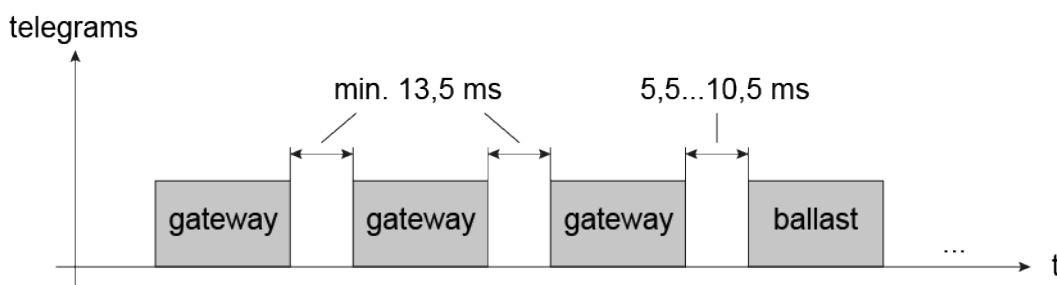

Figure 12: Pause times between DALI commands

8.4.1 Parameters for DALI communication

DALI system... -> General

DALI telegram rate limit	Checkbox (yes/no)
<p>Optionally, to reduce the telegram load for the DALI operating devices, and thus reduce the likelihood of errors on the part of some electronic ballasts, it is possible to increase the pause time between commands of the DALI gateway to the operation device. This results in a telegram rate limitation, which can be enabled at this point. Further parameters become available when the function is enabled.</p>	

Time delay between two DALI commands	14 ms 20 ms 27 ms 34 ms 41 ms 47 ms 54 ms 61 ms 68 ms
--------------------------------------	--

If telegram rate limitation is activated, this parameter defines the delay between the DALI commands of the gateway.

Time delay between two DALI commands	1...10...30 s
<p>After the mains voltage supply is switched on, DALI operating devices usually require different lengths of time to initialise themselves and thus to react to commands of the gateway, depending on their type. To ensure that, after the mains voltage returns, no commands of the gateway to the operating devices are lost, because they are still initialising, it is possible to configure a delay as an option here.</p> <p>This parameter can be activated only if telegram rate limitation is activated.</p>	

8.5 Central functions

The gateway offers the possibility to specifically connect individual or all group and single devices with up to six central functions. Each central function has a 1-bit object, a 4-bit object and a 1-byte object. The behaviour for controlling a group or single device by means of the central functions can be set to "Switching & dimming" or alternatively to "Permanent" (switching with priority).

Central function = "Switching & dimming":

This function is comparable to various central group addresses that are linked to the objects "Switching - Setting", "Dimming - Setting" and "Brightness value - Setting" of a group or single device. The last command received (ON or OFF, dimming or brightness value) is executed. The polarity of the switching telegram can be configured as inverted if necessary.

The parameter "With relative dimming up in the switched-off state" defines whether a group or single device in the "OFF" state reacts to a relative dimming telegram of the central dimming object or not.

Central function = "Permanent":

The assigned groups and single devices are controlled according to the parameterised command (ON or OFF) and locked during central control. The "Dimming" and "Brightness value" objects of the central function are not evaluated by the assigned groups and single devices. This means that no other central function with the "switching & dimming" function can control a locked group or single device. Controls via normal switching objects are possible. If a group or single device is assigned to several permanent central functions, the configured command decides on the priority of the central function. A "permanent OFF" has a higher priority than a "permanent ON" and thus is preferably executed. Activating a central function "permanent OFF" deactivates other assigned functions for a group or single device with the setting "permanent ON".

Example of permanent central functions

A group is assigned to the central function 1 "Switching", central function 2 "Permanent OFF" and central function 3 "Permanent ON". Central functions 2 and 3 are initially deactivated.

When a central telegram = "activate" is received on central function 3, the assigned group switches on. In this state, it can no longer be controlled by central function 1, since a simple "switching" has a lower priority. When a central telegram = "activate" is received on central function 2, the assigned group switches off immediately. Central function 3 is thus deactivated automatically. Only when central functions 2 and 3 are deactivated can the assigned group be controlled again by central function 1.

i All central functions are inactive after the bus/mains voltage returns. No central functions are saved in the event of a bus/mains voltage failure.

In the case of control by a central function, the transmission of the switching status and brightness value can be delayed for each group and single device.

Disconnect central functions

- The central functions on the parameter page "DALI system... -> General" with the "Central functions" parameter.

The central objects become visible in the ETS. Names can optionally be assigned for the central functions. The names should illustrate the use of the individual central functions (e.g. "All ON", "Central OFF"). The names are only used in the ETS in the text of the central functions and central objects.

Assigning groups and single devices to the central functions

Each group and single device can be assigned to the central functions.

The central functions must be enabled.

- On the parameter pages "DALI system... -> Configuration groups -> [x] Group name" or "DALI system... -> Configuration single devices -> [x] Device name", set the parameter "Central functions Function and Polarity" to the desired function.

The respective group or single device is assigned to the central function. It can be influenced centrally.

- i** The new state set by the central functions is tracked in the status objects and also transmitted to the KNX.

8.5.1 Parameters for central functions

DALI system... -> General

Central functions	Checkbox (yes/no)
If the parameter is activated, the six central functions and thus the objects "DALI system... - Central function..." enabled. It is possible to assign individual groups and single devices to the central functions only if the function is enabled.	

Name of the central functions	Free text
Names can optionally be assigned for the central functions. The names should illustrate the use of the individual central functions (e.g. "All ON", "Central OFF"). The names are only used in the ETS in the text of the central functions and central objects.	

DALI system... -> Configuration groups -> [x] Group name

DALI system... -> Configuration of single devices -> [x] Device name

Delay for feedbacks	Checkbox (yes/no)
The states of the switching status and brightness value objects can be transmitted to the KNX with a delay in the event of control with a central function.	
The parameter is visible only if central functions are enabled.	

Delay time	0 ... 59 min 0 ... 5 ... 59 s
<p>These parameters define the time delay for the switching status and brightness value feedback for control with a central function.</p> <p>These parameters are only available if the delay for feedback signals is activated.</p>	
Assignment...	Checkbox (yes/no)
<p>This parameter assigns the supplementary functions to the selected group or single device.</p> <p>The parameter is visible only if central functions are enabled.</p>	
Function and polarity	Switching (1 = ON / 0 = OFF) & dimming Switching (0 = ON / 1 = OFF) & dimming Permanent ON (switching: 1 = active / 0 = inactive) Permanent OFF (switching: 1 = active / 0 = inactive)
<p>The function and polarity of the central function is selected here.</p> <p>Switching (1 = ON/0 = OFF) & dimming: The last command received (ON or OFF) or dimming is executed. The polarity of the central telegram for switching is preset: 1 = ON/0 = OFF</p> <p>Switching (0 = ON/1 = OFF) & dimming: The last command received (ON or OFF) or dimming is executed. The polarity of the central telegram for switching is preset: 0 = ON/1 = OFF</p> <p>Permanent ON (1 = active / 0 = inactive): The assigned group or single device is switched on and locked during central control. The "Dimming" object and "Brightness value" object of the central function are not evaluated by the assigned groups or single devices.</p> <p>Permanent OFF (1 = active / 0 = inactive): The assigned group or single device is switched off and locked during central control. The "Dimming" object and "Brightness value" object of the central function are not evaluated by the assigned groups or single devices.</p> <p>If a group or single device is assigned to several permanent central functions, the configured command decides on the priority of the central function. A "permanent OFF" has a higher priority than a "permanent ON" and thus is preferably executed. With permanent function, the polarity of the central telegram is always fixed: 1 = activate permanent control / 0 = deactivate permanent control.</p> <p>This parameter is visible only if central functions are enabled and assigned.</p>	

With relative dimming up in the switched-off state	switch-on no reaction
<p>This parameter defines whether a group or single device in the "OFF" state reacts to a relative dimming telegram.</p> <p>Switch-on: The group or single device always reacts to a relative dimming telegram and executes a dimming process. In the "OFF" state, the group or single device switches on in the event of a "dim up" telegram.</p> <p>No reaction: The group or single device reacts to a relative dimming telegram only when it is switched on. In the "OFF" state, the group or single device ignores a "dim up" telegram.</p> <p>The parameter is visible only with enabled central functions and the "switching & dimming" function.</p>	

8.5.2 Objects for central functions

Function	Name	Type	DPT	Flag
Switching	DALI system... - Central function... - Input	1-bit	1.001	C, -, W, -, U
1-bit object for central switching of the group or single device.				

Function	Name	Type	DPT	Flag
Dimming	DALI system... - Central function... - Input	4-bit	3.007	C, -, W, -, U
4-bit object for central relative dimming of the brightness of the group or single device.				

Function	Name	Type	DPT	Flag
Brightness value	DALI system... - Central function... - Input	1-byte	5.001	C, -, W, -, U
1-byte object for central specification of an absolute brightness value within the limits of minimum to maximum brightness.				

8.6 Status functions

Delay after bus/mains voltage return

To reduce telegram traffic on the bus line after the bus voltage (bus reset) or the mains voltage supply is switched on, after connection of the device to the bus line or after programming with the ETS, it is possible to delay all actively transmitted feedback telegrams of the gateway. For this purpose, a delay time can be defined across functions. Only after the configured time has elapsed are status telegrams for initialisation transmitted to the KNX.

Which status telegrams are actually delayed can be configured independently for each status function.

- i** The delay has no effect on the behaviour of the individual groups or single devices and not on other functions of the device either. Only the status telegrams are delayed. Groups and single devices can be controlled also during the delay after the bus/mains voltage returns.
- i** A setting of "0" for the delay after the bus/main supply returns deactivates the delaying function completely. In this case, all status telegrams are transmitted to the KNX without delay.

8.6.1 Collective feedback switching status

After central commands or after the bus/mains voltage returns, a KNX line is generally heavily loaded by telegrams because numerous bus devices transmit the state of their communication objects as status. This effect occurs particularly when using visualisations. Collective feedback of the gateway can be used to keep the telegram load low during initialisation.

The collective feedback summarises the switching states of the groups and single devices in bit-orientated form. Up to four separate 4-byte communication objects according to KNX DPT 27.001 are available for this, depending on the set addressing type. Each of these objects can visualise the switching state of up to 16 groups or single devices.



Figure 13: Structure of the objects of the collective feedback, using the example of the object for Groups 1-16

It is possible to show up to 16 groups or single devices and thus up to 16 different switching states logically in a 4-byte object. Each group or each single device has one bit representing the switching state ("S"-bit) and another one defining the masking ("M" bit). The "S"-bits correspond to the logical non-inverted switching states of the groups or devices and are either "1" (on) or "0" (off). The M-bits are "1" when the

corresponding group or the appropriate single device has been created in the project design of the gateway. Similarly, M-bits are "0" when groups or devices are not available. In this case, the corresponding "S"-bits are continuously "0", as there is no switching status.

After a device reset (ETS programming operation, bus or mains voltage return), the gateway transmits all the collective feedback according to the configured addressing type. If only individual switching states change in gateway operation, only the affected collective feedback objects are updated.

The following example object value formats result...

Groups 1 to 4 available: "00 0F 00 0x", x = switching states

-> Group 1 and 2 ON: "00 0F 00 03" / Group 1 and 3 ON: "00 0F 00 05"

Groups 1 to 6 available: "00 3F 00 xx", x = switching states

-> Group 1 and 2 ON: "00 3F 00 03" / Group 1 and 5 ON: "00 3F 00 11"

Groups 1 to 4 and 10 to 12 available: "0E 0F 0x 0x", x = switching states

-> Group 1 and 4 ON: "0E 0F 00 09" / Group 1 and 10 ON: "0E 0F 02 01"

Use of the collective feedback would be possible in appropriate visualisation applications - for example in public buildings such as schools or hospitals - where the switching states of the actuators are displayed centrally and no separate switching status is displayed at the control sections. In such applications the collective feedback can replace the 1-bit individual feedbacks and thereby significantly reduce the bus load.

Activate collective feedback

The "switching status collective feedback" is a global function for each DALI system and can be enabled on the parameter page "DALI system... -> General".

- Activate the parameter "Collective feedback".
Collective feedback is enabled. The collective feedback objects become visible in the ETS. Depending on the configured addressing type, up to 4 objects are displayed for groups and / or single devices.
- Deactivate the parameter.
Collective feedback is deactivated. No collective feedback objects are available.

Setting the update of collective feedback

In the ETS, it can be defined when the gateway updates the feedback value for the collective feedback. The object value most recently updated by the gateway is then actively reported to the KNX, provided the "Transmit" flag is set on the communication objects.

The parameter "Updating of the object value" is available on the parameter page "DALI system... -> General".

Collective feedback must be enabled.

- Set the parameter to "after each update object 'Switching'/'Central'"
The gateway updates the feedback values in the collective feedback as soon as a new telegram is received for groups or single devices at the input objects "Switching - Setting" or "Central function... - Switching". A new telegram is also then actively transmitted to the KNX each time. The telegram value does not necessarily have to change. Hence, corresponding collective feedbacks are also generated, e.g. in the event of cyclical telegrams to the input objects.
- Set the parameter to "Only if the feedback value changes".
The gateway only updates the feedback values in the collective feedback objects when the telegram values of the inputs also change. The feedback remains unchanged if telegram values do not change (e. g. in the event of cyclical telegrams to the input objects with the same telegram value). Consequently, no telegram with the same content is then issued repeatedly.

Setting collective feedback after bus/mains voltage return or after programming with the ETS

The states of the collective feedback are transmitted to the KNX after the bus or mains voltage returns or after an ETS programming operation. In these cases, the feedback telegram can be time-delayed, with the delay set globally for all groups and single devices together.

The parameter "Delay after bus/mains voltage return" is available on the parameter page "DALI system... -> General".

Collective feedback must be enabled.

- Activate the parameter.
The collective feedback objects are transmitted with a delay after bus or mains voltage return or after programming with the ETS. No feedback telegram is transmitted during a running delay, even if a switching state changes during this delay.
- Deactivate the parameter.
The collective feedback is transmitted immediately after bus or mains voltage return or after programming with the ETS.

Setting the cyclical transmission of the collective feedback

The objects of the collective feedback can also transmit their value cyclically in addition to transmission when updating.

The "Cyclical transmission" parameter is available on the parameter page "DALI system... -> General".

Collective feedback must be enabled.

- Activate the parameter. Configure the desired time for cyclical transmission in the "Cycle time" parameter.
Cyclical transmission is activated.

- Deactivate the parameter.
Cyclical transmission is deactivated which means that collective feedback is transmitted to the KNX only if one of the switching states changes.
- i** During an active delay after bus voltage return no collective feedback telegram will be transmitted even if a switching state changes.

8.6.2 DALI feedback telegrams

Feedback for DALI short-circuit

The gateway detects short-circuits on the DALI cable, as may occur in the case of an installation error. As soon as a short-circuit is identified on the DALI cable with the mains power supply switched on, the gateway transmits a status to the KNX when the status function for DALI short-circuits is enabled.

The gateway uses the 1-bit communication object "Status - DALI short-circuit" for the status of a DALI short-circuit. The telegram polarity of this object is fixed: No short-circuit = 0, Short-circuit = 1.

Setting feedback for DALI short-circuit

In the ETS, it can be defined whether the status for a DALI short circuit is to be transmitted to the KNX. When enabled, telegram transmission is always actively transmitting. As soon as a short-circuit has been detected and eliminated, the gateway transmits a status telegram without a delay. The parameter "DALI short circuit" on the parameter page "DALI system... -> General" defines the behaviour of the short-circuit monitoring.

- Activate the parameter.
The status for a DALI short circuit is activated and the communication object is available.
- Deactivate the parameter.
The status for a DALI short circuit is deactivated. The communication object is hidden.
- i** The connected DALI operating devices also react to a short-circuit in the DALI cable. The devices set themselves to the specified "System Failure Level". This brightness value is defined by the behaviour "in case of bus voltage failure" parameter of a group or single device.
- i** The status of a DALI short-circuit can be transmitted only if the bus voltage is connected and switched on at the time of the short-circuit. If no bus voltage is connected and switched on at the time of the short-circuit, no status is transmitted either. Feedback is saved, however, which means that it is transmitted later when the bus voltage is switched on.

- i** The gateway initialises after switching on the mains power supply or after an ETS programming operation. If a short circuit is detected on the DALI line in this state, the gateway also transmits a corresponding status. After the bus voltage returns (mains voltage switched on permanently at the gateway during bus failure), the feedback is not automatically sent on the bus.

Feedback for mains voltage supply at the gateway

The gateway can monitor its supply voltage at the mains voltage connection. If there is a failure, the gateway is able to transmit a status telegram to the KNX before stopping operation, provided the bus voltage is uninterrupted. Optionally, the switch-on of the mains voltage supply can also be fed back.

If the mains voltage supply of the gateway and the connected DALI operating devices are connected to the same circuit, the operating state of an entire DALI system can be monitored on the KNX side by evaluating the mains voltage status.

For the status of a power failure or mains voltage return, the 1-bit communication object "Status - Supply voltage" is used at the gateway. The telegram polarity of this object is fixed: Mains voltage available = 0, Mains voltage failure = 1.

Setting feedback for mains voltage supply

In the ETS, it is possible to define whether only a failure of the mains voltage supply of the gateway is reported to the KNX or additionally also a mains voltage return. Telegram transmission is always actively transmitting. As soon as there is a change of state in the mains voltage, a feedback telegram is transmitted once. The parameter "Supply voltage" on the parameter page "DALI system... -> General" defines the behaviour of the mains voltage monitoring.

- Activate the parameter. In addition, configure the "Transmission behaviour" parameter to "only on power failure".
As soon as a mains voltage failure is detected at the gateway, the device immediately transmits a status telegram. It stops operation just a few seconds later.
- Activate the parameter. In addition, configure the "Transmission behaviour" parameter to "on power failure and return".
As soon as a mains voltage failure is detected at the gateway, the device immediately transmits a status telegram. It stops operation just a few seconds later. The gateway initialises itself when the mains power supply is switched on. Then it transmits a status telegram once and signals that the mains voltage is switched on.
- Deactivate the parameter.
The status of the mains power supply state is deactivated. The communication object is hidden.

- i** The status of a mains voltage failure can be transmitted only if also the bus voltage is connected and switched on at the time of the failure. If no bus voltage is connected and switched on when the mains voltage returns, no status is transmitted either. Feedback is saved, however, which means that it is subsequently transmitted when the bus voltage is switched on later.
- i** The status is not transmitted automatically to the KNX after the bus voltage returns or after an ETS programming operation.

DALI busy

During operation of the gateway, it is possible for the telegram load of the DALI system concerned to increase, especially if a number of control functions of the groups and single devices are running simultaneously. The gateway signals "DALI busy" if the load reaches or exceeds a defined limit with the effect that trouble-free operation of the DALI system is no longer guaranteed. This signalling takes place if the parameter is activated on the 7-segment display of the device ("db" indication) and optionally also to the KNX by means of a 1-bit communication object "Status - DALI busy".

A DALI busy can occur, for example, if several colour wheel sequences run simultaneously in different groups or single devices. This can lead to continuous or intermittent overloading of the DALI system, which means that hues cannot always be safely transmitted to the operating devices. To identify such disturbed operation, the DALI busy status can be used.

- i** With the "2-gang" product variant, the DALI system (1 or 2) affected by the load is additionally signalled by the corresponding status LED. If both DALI systems are affected, signalling takes place simultaneously with both status LEDs.
- i** A DALI system is considered to have a maximum load if a DALI telegram is sent approx. every 35 ms. This corresponds to approx. 28 DALI telegrams per second. The limit value for detecting a DALI busy is set to a load of approx. 75%.

If the gateway detects a heavily loaded DALI system, it indicates this overload for a duration of 10 seconds on the 7-segment display and also via the KNX status object. If the load continues beyond this time, the gateway automatically extends the indication for at least ten more seconds. The status in the KNX object is then also retained. The gateway revokes the status only when the load of the DALI system falls below the defined limit value again.

Optionally, an acknowledgement can be used. In this case, the gateway resets the status in the DALI busy object only when confirmation has been received by the separate 1-bit acknowledgement object.

- i** In the event of a DALI busy, the gateway attempts to send out all the necessary control commands in sequence and completely on the DALI line. Commands received via KNX (e. g. switching, dimming, values) or specifications regarding internal functions of groups and single devices (e.g. colour wheel

sequence, HCL or CTM matrices) are transferred to the DALI side as quickly as possible. However, this can lead to noticeable delays or even telegram losses due to the high load of the DALI system!

Setting DALI busy

The status for the indication of a DALI busy can be configured separately in each DALI system on the parameter page "DALI system... -> General".

- Activate the parameters "DALI busy" and "Acknowledgement".

The "DALI busy" status is activated. As soon as the gateway identifies a heavily loaded DALI system, it indicates "db" on the 7-segment display on the front of the device. In addition, the 1-bit object "Status - DALI busy" is available, which signals the load also by means of an ON telegram. To confirm this status message, an ON telegram must be received by means of the 1-bit object "Acknowledgement - DALI busy". Only after acknowledgement has taken place does the gateway reset the status in the object "Status - DALI busy" with an OFF telegram. If the load in the DALI system remains high after acknowledgement, the gateway sets the status again so that another acknowledgement is required.

The acknowledgement has no influence on the 7-segment display. The "db" indication goes out automatically as soon as the load in the DALI system returns to normal.

- Activate the "DALI busy" parameter and deactivate the "Acknowledgement" parameter.

The "DALI busy" status is activated. As soon as the gateway identifies a busy DALI system, it indicates "db" on the 7-segment display on the front of the device. In addition, the 1-bit object "Status - DALI busy" is available, which signals the load also by means of an ON telegram. Confirmation of this status message is not required. The gateway automatically revokes the status with an OFF telegram as soon as the load of the DALI system returns to normal.

- i** No DALI busy is generated during ongoing DALI commissioning or device initialisation after an ETS programming operation.
- i** The gateway does not automatically transmit the DALI busy status after a device reset (ETS programming operation, bus/mains voltage return) even if the status was active before the reset. The status is only reported when a high load occurs after initialisation of the gateway.

8.6.3 DALI error status

Error status in DALI system

The gateway allows the error status of DALI operating devices to be indicated. The general status "Error in DALI system" can be used if individual evaluation and indication of the error status of individual electronic ballasts or groups and single devices is not required or is to be supplemented with a status function, independent of the elec-

tronic ballast. This status function has the 1-bit communication object "Status - Error - DALI system", which allows a general error to be indicated in the DALI installation. The gateway sets the object value to "ON" as soon as it detects an error in a previously commissioned DALI operating device. Here, it is irrelevant which error was identified by the gateway (lamp error, electronic ballast error). The gateway does not reset the object value to "OFF" until all the previously identified errors have been eliminated.

To use the status function, the parameter "Error in DALI system" must be activated on the parameter page "DALI system... -> General". The parameter "Telegram repetition with new error" determines whether status telegrams are generated repeatedly if several errors occur in the DALI system in succession.

Setting the error status in the DALI system

The error status in the DALI system is implemented as an active signalling object. The gateway automatically transmits the status to the KNX with every change.

- Activate the parameter "Error in DALI system".
The error status in the DALI system is transmitted as soon as the state changes.
- Deactivate the parameter "Error in DALI system".
The error status in the DALI system is not available.

i An error status saved in the gateway in the DALI system is lost when the mains voltage fails. For this reason, after all the errors have been eliminated by switching the mains voltage off and on again at the gateway, no status is transmitted any more.

i The gateway initialises after switching on the mains power supply or after an ETS programming operation. If a DALI error is detected in this state, the gateway also transmits an appropriate status telegram. After the bus voltage returns (mains voltage switched on permanently at the gateway during a bus failure), the feedback is not automatically sent to the KNX.

Optionally, the error status in the DALI system can be transmitted repeatedly, if, after a previously identified DALI error, further errors are detected on the same or other operating devices. The parameter "Telegram repetition with new error" defines the behaviour of the general error status in the event of new errors.

- Activate the parameter.
The general error status is transmitted as "ON" for each new error.
- Deactivate the parameter.
The general error status is transmitted repeatedly for new errors. An OFF telegram is sent again via the object "Status - Error - DALI system" only when there is no longer any error.

Error status per DALI operating device

The gateway allows the feedback of the individual error status of DALI operating devices in up to two different data formats. To use this feedback function, the parameter "Error per DALI control gear" must be activated on the parameter page "DALI system... -> General". The parameter "Data format" that is then available determines whether only a 1-byte object (according to KNX DPT 238.600), a 2-byte object (according to KNX DPT 237.600) or a combination of both objects is used.

The status information "Lamp error" or "Error in operating device (e.g. electronic ballast error)" is transmitted to the gateway by the DALI components if there is an error, and is saved there. The gateway makes all the status information about the KNX-side error status objects available. The object values are evaluated in bit-orientated fashion according to the selected data format. A feedback telegram always transmits the status information of only one DALI operating device.

As the master in the DALI system, the gateway - as soon as it is ready for operation - queries the status of the commissioned electronic ballasts (slaves) cyclically every second. A system with a maximum of 64 DALI devices can identify an error after 63 seconds at the latest. Once an error has occurred in the operating device, it must be eliminated (switch off the mains voltage to the appropriate DALI subscriber and observe the manufacturer's information!). The gateway detects an eliminated error automatically after commissioning the repaired device and resets the error state in the feedback.

1-byte error status

Bits 0...5 of the 1-byte error status telegram use the electronic ballast number to indicate to which device the signalled error relates. The electronic ballast numbers of the error status are derived directly from the short addresses of the DALI subscribers. An electronic ballast number (0...63) corresponds to a short address (1...64) minus "1" (example: Short address = "1" -> Electronic ballast number in the error status telegram = "0").

- i When an error status is displayed, it is irrelevant whether the electronic ballast was assigned to a single device or a group during project design.

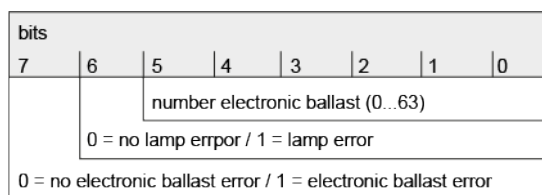

Figure 14: Telegram structure, 1-byte error status

Bit 6 is set when the appropriate electronic ballast signals a lamp error (e.g. defective lamp, cable break to lamp socket). In an error-free lamp state, this bit is deleted ("0"). Bit 7 is set when the electronic ballast signals a general error (e.g. internal electronic ballast error). In an error-free device state, this bit is deleted ("0"). Bit 7 is also set if the appropriate device could not be addressed by the gateway (e. g. device disconnected from the DALI cable, mains voltage at the electronic ballast switched off).

2-byte error status

In this data format too, bits 0..5 use the electronic ballast number to indicate to which device the signalled error relates. The electronic ballast numbers of the error status are derived directly from the short addresses of the DALI subscribers. An electronic ballast number (0..63) corresponds to a short address (1..64) minus "1" (example: Short address = "1" -> Electronic ballast number in the error status telegram = "0"). Alternatively, the 2-byte error status can be used to display the collective error state of all the operating devices of a group. For this, the error-bits of the individual electronic ballast are collected and evaluated by the gateway. If any error bit is set in at least one electronic ballast of the group, the same error bit is also set in the feedback telegram.

To distinguish whether the feedback is addressing an electronic ballast or a group, the error status telegram contains bit 6. This bit indicates whether a single device ("0") or a group ("1") is addressed. When addressing a group, bits 0..5 must contain the group number in the DALI system. A DALI group number (0..15) corresponds to a projected group number (1..16) minus "1" (example: projected group number = "1" -> DALI group number in error status telegram = "0").

Bit 7 in the telegram indicates whether this is a request telegram ("1") or, alternatively, an actively transmitted telegram, or an answer to a request telegram ("0").

- i** When the error status of an electronic ballast is displayed, it is irrelevant whether the operating device was assigned to a single device or a group in the project design. In the case of active telegram transmission, if an error has been identified, only the error status for an individual electronic ballast is generally transmitted and not for a group, provided that the appropriate electronic ballast is also assigned to a group.

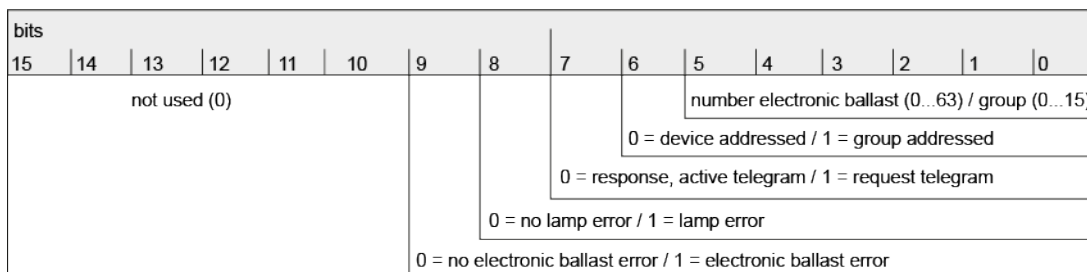

Figure 15: Telegram structure, 2-byte error status

Bit 8 is set when the appropriate electronic ballast or the group signals a lamp error (e.g. defective light, cable break to lamp socket). In an error-free lamp state, this bit is deleted ("0").

Bit 9 is set when the electronic ballast or the group signals a general error (e.g. internal electronic ballast error). In an error-free device state, this bit is deleted ("0"). Bits 9 is also set if the appropriate device or an electronic ballast of a group could not be addressed by the gateway (e. g. device disconnected from the DALI cable, mains voltage at the electronic ballast switched off).

Setting the error status per DALI operating device

It must first be defined whether the 1-byte or 2-byte error status is used, or a combination of both objects.

- Set the parameter "Data format" to "only 2-byte object".
Only the 2-byte object in accordance with KNX DPT 237.600 is available. This object can be used both actively and passively (request telegram) and should preferably be used in accordance with the KNX specification.
- Set the parameter "Data format" to "only 1-byte object".
Only the 1-byte object in accordance with KNX DPT 238.600 is available. This object can be used both actively and passively (request telegram).
- Set the parameter "Data format" to "1-byte and 2-byte object".
The 2-byte object is available in accordance with KNX DPT 237.600, and the 1-byte object is also available in accordance with KNX DPT 238.600. Both objects can be used both actively and passively (request telegram).

Optionally, a delay of the error status after initialisation of the gateway (ETS programming operation, mains voltage return) can be activated by the parameter "Delay after mains voltage return and ETS programming operation". The delay is configured globally on the same parameter page by the parameter "Delay after bus/mains voltage return".

The error status per DALI operating device can be used as an actively transmitting status object or additionally also as a status object that reacts to an external request telegram.

- Actively use the error status per DALI operating device.
As soon as an error is detected on a DALI operating device during the cyclical status query, the gateway transmits a feedback telegram with the appropriate electronic ballast/group number to the KNX.
As soon as the error has been eliminated, the gateway detects the error elimination, provided that the operating power supply of the gateway was not interrupted, and, accordingly, transmits a "No error" feedback telegram to the KNX. Should multiple errors have been identified on various electronic ballasts, these will not be retransmitted to the KNX when a device or lamp error is eliminated. The transmission of a feedback telegram related to a DALI operating device or a group will thus only take place once after determination of the error.
- i** In the case of active telegram transmission, if an error has been identified, only the error status for an individual electronic ballast is generally transmitted and not for a group, provided that the appropriate electronic ballast is also assigned to a group.
- i** An error saved in the gateway is lost when the mains voltage fails. For this reason, after an error has been eliminated by switching the mains voltage off and back on again at the gateway, no feedback is transmitted any more.
- i** The gateway initialises after switching on the mains power supply or after an ETS programming operation. If a DALI error is detected in this state, the gateway will immediately transmit an appropriate feedback telegram.
- Use error status per DALI operating device with request telegram.

To determine the error status of a DALI operating device or a group, the communication object "Status - Error - Operating device" can be written to externally with a request telegram (ValueWrite). Here, a distinction is made as to whether the 1-byte or 2-byte error status is used...

1-byte error status: Bits 0...5 of the request telegram must contain the number of the electronic ballast, from which the status is to be queried. Bits 6 and 7 must be set to "1"! Otherwise, the request telegram is ignored.

2-byte error status: Bit 7 must be set in the request telegram ("1"). Bit 6 must indicate whether a group ("1") or an individual electronic ballast ("0") is being addressed. Bits 0...5 must then contain the number of the electronic ballast or DALI group number. The states of error-bits 8...9 are irrelevant in the request telegram. Bits 10...15 must always be "0"! Otherwise, the request telegram is ignored.

The gateway immediately responds to a received, valid request telegram (ValueWrite) by transmitting the current status once as a response.

- i** Request telegrams to electronic ballast or group numbers, which are not configured in the DALI system and are thus not available, are always answered with deleted error-bits. Request telegrams to group numbers greater than 15 (group number greater than 16) are never answered.
- i** A read telegram (ValueRead) on the communication object "Status - Error status - Operating device" is answered by the gateway transmitting the most recently updated object value provided the read flag is set (ValueResponse). This means that DALI operating devices cannot be polled clearly.

Error status per DALI group / single device

In addition to signalling a general DALI error status in the DALI system and the individual feedback of the error status of a DALI operating devices by means of the 1-byte and 2-byte communication objects, the gateway also enables the indication of an error status identified in a projected group or single device. All error status functions can be used simultaneously.

The error status per DALI group / single device has a 1-bit communication object "Error - Status" for each projected group and each single device, which allows an error to be indicated directly in the group or at the single device. The gateway sets the object value to "ON" as soon as it detects an error. Here, it is irrelevant which error was identified by the gateway (lamp error, electronic ballast error). The gateway does not reset the object value to "OFF" until the previously identified error has been eliminated.

To use the status function, the parameter "Error per DALI group/single device" must be set on the parameter page "DALI system... -> General". When the function is activated, the parameter "Telegram repetition on new error" is available for each group and single device on the parameter page "DALI system... -> Configuration groups -> [x] Group name" or "DALI system... -> Configuration single devices -> [x] Device name", which determines whether status telegrams are repeatedly generated if several errors occur in succession.

Setting the error status per DALI group / single device

The error status per DALI group / single device is implemented as an active signalling object. The gateway automatically transmits the status to the KNX with every change.

- Activate the parameter "Error per DALI group / single device" on the parameter page "DALI system... -> General".

The 1-bit object "Error - Status" becomes available per projected group and single device. The error status per DALI group/single device is transmitted as soon as the state changes.

- Deactivate the parameter "Error per DALI group / single device".

The error status per DALI group / single device is not available.

i An error status saved in the gateway per DALI group / single device is lost if the mains voltage fails. For this reason, after all the errors have been eliminated by switching the mains voltage off and on again at the gateway, no status is transmitted any more.

i The gateway initialises after switching on the mains power supply or after an ETS programming operation. If a DALI error is detected in this state, the gateway also transmits an appropriate status telegram. After the bus voltage returns (mains voltage switched on permanently at the gateway during a bus failure), the feedback is not automatically sent to the KNX.

Optionally, the error status per DALI group / single device can be transmitted repeatedly if further errors are detected after a previously identified DALI error. The parameter "Telegram repetition on new error" on the parameter page "DALI system... -> Configuration groups -> [x] Group name" or "DALI system... -> Configuration single devices -> [x] Device name" defines the behaviour of the general error status in the event of new errors.

- Activate the parameter.

The general error status is transmitted as "ON" for each new error.

- Deactivate the parameter.

The general error status is transmitted repeatedly for new errors. An OFF telegram is sent again by means of the "Error - Status" object only when there is no longer any error.

8.6.4 Parameters for status functions

DALI system... -> General

Delay after bus/mains voltage return	0...59 min 0...17...59 s
<p>This parameter provides a global definition of the delay time for automatic transmission of the status functions after a device reset for all groups and single devices of the DALI system.</p> <p>The setting "0" deactivates the delay completely. In this case, all status telegrams are transmitted to the KNX without delay.</p>	
Collective feedback	Checkbox (yes/no)
<p>After central commands or after the bus/mains voltage returns, a KNX line is generally heavily loaded by telegrams because numerous bus devices transmit the state of their communication objects as status. This effect occurs particularly when using visualisations. Collective feedback of the gateway can be used to keep the telegram load low during initialisation.</p> <p>The collective feedback summarises the switching states of the groups and single devices in bit-orientated form. Up to four separate 4-byte communication objects are available for this, depending on the set addressing type. Each of these objects can visualise the switching state of up to 16 groups or devices.</p>	
Updating of the object value	After each update "Switching"/"Central" object only if the feedback value changes
<p>At this point, you can define when the gateway is to update the status of the collective feedback. The object value most recently updated by the gateway is then actively reported to the KNX, provided the "Transmit" flag is set on the communication objects.</p> <p>Each time the object "Switching"/"Central switching" is updated, the gateway updates the feedback values in the collective feedback as soon as a new telegram is received for groups or single devices at the input objects "Switching - Setting" or "Central function... - Switching". A new telegram is also then actively transmitted to the KNX each time. The telegram value does not necessarily have to change. Hence, corresponding collective feedbacks are also generated, e.g. in the event of cyclical telegrams to the input objects.</p> <p>Only if the feedback value changes: The gateway updates the feedback values in the collective feedback objects only if the telegram values of the inputs also change. The feedback remains unchanged if telegram values do not change (e. g. in the event of cyclical telegrams to the input objects with the same telegram value). Consequently, no telegram with the same content is then issued repeatedly.</p>	

Delay after bus/mains voltage return	Checkbox (yes/no)
The states of the collective feedback are transmitted to the KNX after the bus or mains voltage returns or after an ETS programming operation. In these cases, the feedback telegram can be time-delayed, with the delay set globally for all groups and single devices together.	
Cyclical transmission	Checkbox (yes/no)
The objects of the collective feedback can also transmit their value cyclically in addition to transmission when updating.	
Cycle time	0...23 h 0...2...59 min 0/(10)...59 s
The collective feedback can also be transmitted cyclically, in addition to transmission in the event of an update. If cyclical transmission is activated, the cycle time can be configured here.	
Supply voltage	Checkbox (yes/no)
The gateway can monitor its supply voltage at the mains voltage connection. If there is a failure, the gateway is able to transmit a status telegram to the KNX before stopping operation, provided the bus voltage is uninterrupted. Optionally, the switch-on of the mains voltage supply can also be fed back.	
Transmission behaviour	only on power failure on power failure and return
<p>This parameter defines when the status for the supply voltage is transmitted by the gateway.</p> <p>Only on voltage failure: As soon as a mains power failure is detected at the gateway, the device immediately transmits a status telegram. It stops operation just a few seconds later.</p> <p>On voltage failure and return: As soon as a mains power failure is detected at the gateway, the device immediately transmits a status telegram. It stops operation just a few seconds later. The gateway initialises itself when the mains power supply is switched on. Then it transmits a status telegram once and signals that the mains voltage is switched on.</p> <p>This parameter is available only if mains voltage monitoring is enabled.</p>	
DALI short circuit	Checkbox (yes/no)
The gateway detects short-circuits on the DALI cable, as may occur in the case of an installation error. As soon as a short-circuit is identified on the DALI line with the mains power supply switched on, the gateway transmits a status to the KNX when the status function for DALI short-circuits is enabled here.	

DALI busy	Checkbox (yes/no)
<p>During operation of the gateway, it is possible for the telegram load of the DALI system concerned to increase, especially if a number of control functions of the groups and single devices are running simultaneously. The gateway signals DALI busy if the load reaches or exceeds a defined limit so that trouble-free operation of the DALI system is no longer guaranteed. This signalling takes place if the parameter is activated on the 7-segment display of the device ("db" indication) and optionally also to the KNX by means of a 1-bit communication object "Status - DALI busy".</p>	
Acknowledgement	Checkbox (yes/no)
<p>Acknowledgement prevents the simple confirmation of a DALI busy by the object "Status - DALI busy".</p> <p>Checkbox activated: DALI system identified, it indicates "db" on the 7-segment display on the front of the device. In addition, the 1-bit object "Status - DALI busy" is available, which signals the load also by means of an ON telegram. To confirm this status message, an ON telegram must be received by means of the 1-bit object "Acknowledgement - DALI busy". Only after acknowledgement has taken place does the gateway reset the status in the object "Status - DALI busy" with an OFF telegram. If the load in the DALI system remains high after acknowledgement, the gateway sets the status again so that another acknowledgement is required.</p> <p>Checkbox deactivated: The "DALI busy" status is activated. As soon as the gateway identifies a busy DALI system, it indicates "db" on the 7-segment display on the front of the device. In addition, the 1-bit object "Status - DALI busy" is available, which signals the load also by means of an ON telegram. Confirmation of this status message is not required. The gateway automatically revokes the status with an OFF telegram as soon as the load of the DALI system returns to normal.</p> <p>This parameter is available only if DALI busy is enabled.</p>	
Error in DALI system	Checkbox (yes/no)
<p>The gateway allows the error status of DALI operating devices to be indicated. The general status "Error in DALI system" can be used if individual evaluation and indication of the error status of individual electronic ballasts or groups and single devices is not required or is to be supplemented with a status function, independent of the electronic ballast. This status function has the 1-bit communication object "Status - Error - DALI system", which allows a general error to be indicated in the DALI installation. The gateway sets the object value to "ON" as soon as it detects an error in a previously commissioned DALI operating device. Here, it is irrelevant which error was identified by the gateway (lamp error, electronic ballast error, converter error). The gateway does not reset the object value to "OFF" until all the previously identified errors have been eliminated.</p>	
Telegram repetition with new error	Checkbox (yes/no)
<p>Optionally, the error status in the DALI system can be transmitted repeatedly, if, after a previously identified DALI error, further errors are detected on the same or other operating devices. This parameter defines the behaviour of the general error status in the event of new errors.</p> <p>This parameter is available only if the error status in the DALI system is enabled.</p>	

Error per DALI control gear	Checkbox (yes/no)
The gateway allows the signalling of an individual error status of DALI operating devices in up to two different data formats. To use this status function, this parameter must be activated.	

Data format	only 1-byte object only 2-byte object 1-byte and 2-byte object
This parameter determines whether only a 1-byte object (according to KNX DPT 238.600), a 2-byte object (according to KNX DPT 237.600) or a combination of both objects is used.	
This parameter is available only with the error status enabled per DALI operating device.	

Delay after mains voltage return and ETS programming operation	Checkbox (yes/no)
Optionally, this parameter can be used to activate a delay of the error status per DALI operating device after the initialisation of the gateway (ETS programming operation, mains voltage return). The delay time is configured globally on the parameter page "DALI System... -> General".	
This parameter is available only with the error status enabled per DALI operating device.	

Error per DALI group/single device	Checkbox (yes/no)
In addition to the global error status in the DALI system or the error status of the DALI operating devices, the gateway can generate an individual error status per projected group or single device.	

DALI system... -> Configuration groups -> [x] Group name

DALI system... -> Configuration of single devices -> [x] Device name

Telegram repetition with new error	Checkbox (yes/no)
Optionally, the error status per DALI group / single device can be transmitted repeatedly if further errors are detected in the same group or single device after a previously identified DALI error. This parameter defines the behaviour of the error status per DALI group / single device in the event of new errors.	
This parameter is available only with enabled error status per DALI group / single device.	

8.6.5 Objects for status functions

Function	Name	Type	DPT	Flag
Switching status (1...16)	DALI system... - Collective feedback	4-byte	27.001	C, R, -, T, A

4-byte object for collective feedback of an individual switching status of a DALI system. The collective feedback summarises the switching states of the groups and/or single devices with the number [1...16] in just one telegram. The object contains the status information of these groups or single devices in a bit-oriented manner.

Function	Name	Type	DPT	Flag
Switching status (17...32)	DALI system... - Collective feedback	4-byte	27.001	C, R, -, T, A

4-byte object for collective feedback of an individual switching status of a DALI system. The collective feedback summarises the switching states of the groups and/or single devices with the number [17...32] in just one telegram. The object contains the status information of these groups or single devices in a bit-oriented manner.

This object is available only if the configuration of the DALI system concerned provides for a total of at least 17 groups and single devices.

Function	Name	Type	DPT	Flag
Switching status (33...48)	DALI system... - Collective feedback	4-byte	27.001	C, R, -, T, A

4-byte object for collective feedback of an individual switching status of a DALI system. The collective feedback summarises the switching states of the groups and/or single devices with the number [33...48] in just one telegram. The object contains the status information of these groups or single devices in a bit-oriented manner.

This object is available only if the configuration of the DALI system concerned provides for a total of at least 33 groups and single devices.

Function	Name	Type	DPT	Flag
Switching status (49...64)	DALI system... - Collective feedback	4-byte	27.001	C, R, -, T, A

4-byte object for collective feedback of an individual switching status of a DALI system. The collective feedback summarises the switching states of the groups and/or single devices with the number [49...64] in just one telegram. The object contains the status information of these groups or single devices in a bit-oriented manner.

This object is available only if the configuration of the DALI system concerned provides for a total of at least 49 groups and single devices.

Function	Name	Type	DPT	Flag
Status - DALI busy	DALI system...	1-bit	1.002	C, R, -, T, A
<p>1-bit object for signalling a busy DALI system. The gateway signals DALI busy if the load reaches or exceeds a defined limit so that trouble-free operation of the DALI system is no longer guaranteed.</p> <p>The polarity is fixed: "0" = normal telegram utilisation / "1" = high telegram utilisation.</p> <p>This object is available only if the "DALI busy" status message is activated.</p>				

Function	Name	Type	DPT	Flag
Acknowledgment - DALI busy	DALI system...	1-bit	1.016	C, -, W, -, U
<p>1-bit object for acknowledging a DALI busy status message.</p> <p>The polarity is fixed: "0" = no reaction / "1" = status message DALI busy is acknowledged.</p> <p>This object is available only if the status message "DALI busy" and the acknowledgement function are activated.</p>				

Function	Name	Type	DPT	Flag
Status - Error - DALI system	DALI system...	1-bit	1.002	C, R, -, T, A
<p>1-bit object for signalling a general error in the DALI system.</p> <p>The polarity is fixed: "0" = no error / "1" = error.</p> <p>This object is available only if the error status is enabled in the DALI system.</p>				

Function	Name	Type	DPT	Flag
Status - Error - Control Gears	DALI system...	1-byte	238.600	C, R, W, T, A
<p>1-byte object to transmit and read out the error status of individual DALI operating devices connected to the system. The following bit assignment is used:</p> <p>Bit 0...5: number of the DALI operating device (0...63)</p> <p>Bit 6: Lamp error ("0" = No error, "1" = Error)</p> <p>Bit 7: Electronic ballast error ("0" = No error, "1" = Error)</p> <p>This object can always also receive telegrams (ValueWrite) as a transmission request. A received telegram is answered immediately by this object (ValueWrite) by transmitting the queried error status as an answer. In the query telegram, bits 0...5 must contain the number of the electronic ballast (number of electronic ballast error status = short address - 1). Bits 6 and 7 must be set to "1". Otherwise, the query telegram will be ignored.</p> <p>This object is available only if the error status per DALI operating device is enabled and the data format is configured to "1-byte".</p>				

Function	Name	Type	DPT	Flag
Status - Error - Control Gears	DALI system...	2-byte	237.600	C, R, W, T, A
<p>2-byte object to transmit and read out the error status of individual DALI operating devices connected to the system. The error status of all the devices of a group can also be transferred or read out collectively. The following bit assignment is used:</p> <p>Bit 0...5: number of the DALI operating device (0...63) or group (0...15).</p> <p>Bit 6: Address bit ("0" = Individual operating device addressed, "1" = Group addressed)</p> <p>Bit 7: Transmission request ("0" = No transmission request / Response or spontaneous telegram, "1" = Transmission request)</p> <p>Bit 8: Lamp error ("0" = No error, "1" = Error)</p> <p>Bit 9: Electronic ballast error ("0" = No error, "1" = Error)</p> <p>Bit 10: Converter error ("0" = No error, "1" = Error)</p> <p>This object can always receive telegrams (ValueWrite) as a transmission request (bit 7 = "1"). A received telegram is answered immediately by this object (ValueWrite) by transmitting the queried error status as an answer. In the query telegram, bits 0...5 must contain the number of the electronic ballast (number of electronic ballast error status = short address - 1) or that of the group (number of group error status = group number - 1). Bit 6 must show whether this is single device addressing or group addressing. The states of bits 8...10 in the transmission request are irrelevant.</p> <p>This object is available only if the error status per DALI operating device is enabled and the data format is configured to "2-byte".</p>				

Function	Name	Type	DPT	Flag
Error - Status	Group 1...32 / Single device 1...64	1-bit	1.002	C, R, -, T, A
<p>1-bit object for signalling an error individually for a projected group or single device. The polarity is fixed: "0" = no error / "1" = error.</p> <p>This object is available only if the error status is enabled per group / single device.</p>				

8.7 Global switching status / Standby switch-off

The gateway is able to perform a standby switch-off of the connected DALI operating devices to save electrical energy when the lighting is switched off. Alternatively, the gateway provides a function for global reporting of the switching status of all projected groups and single devices.

The standby switch-off or the global switching status is a function across groups and single devices within a DALI system and is set on the parameter page "DALI system... -> General" if required. The "Global status" parameter defines whether the function is used as a standby switch-off or as a switching status. Depending on this setting, further parameters and a 1-bit communication object become visible. The object value is "ON" if at least one group or a single device of the DALI system concerned is switched on (brightness value > 0). The object value is "OFF" if all the groups or single devices are switched off (brightness value = 0). Here, it is not important what switched a group or individual on or off. A KNX command on objects of the groups or single devices or the recall of a scene, for example, cause the function to be updated.

- i** When the standby switch-off is evaluated, the logical switching status of a group or single device is evaluated. It is irrelevant whether all or individual projected groups or devices were assigned electronic ballasts during DALI commissioning, or whether assigned electronic ballasts can be controlled.

8.7.1 Standby switch-off

When using the standby switch-off, a KNX switch actuator must be linked to the status object of the same name (1 bit) of the gateway. For this purpose, an output of the switch actuator in the function as a normally open contact must be connected to the status object of the gateway. The output of the switching actuator switches the mains voltage supply of all the DALI operating devices of the DALI system in concern.

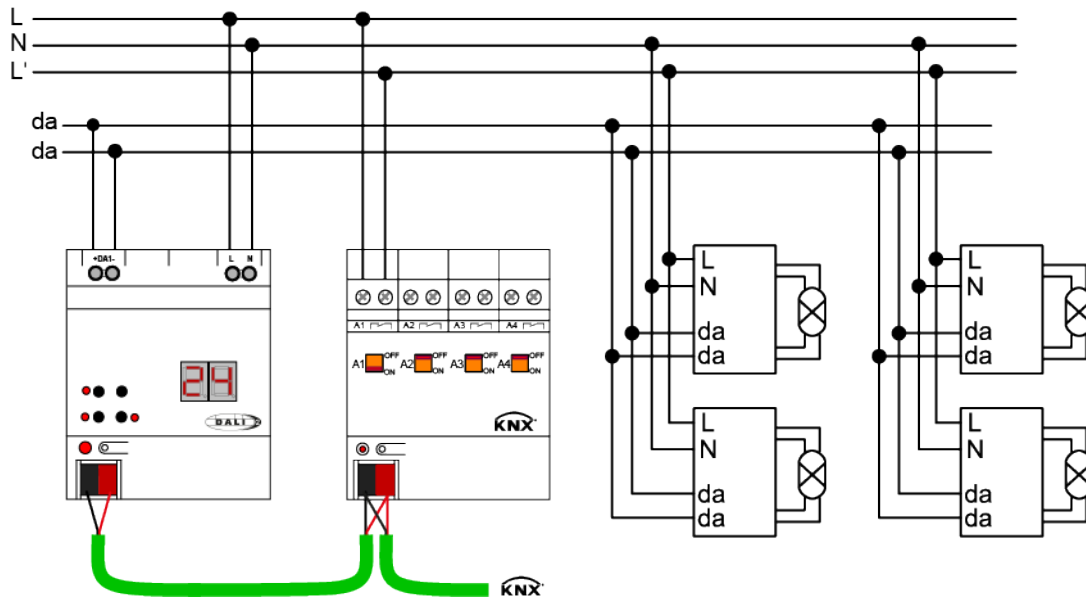

Figure 16: Example of a connection diagram for standby switch-off by a KNX switching actuator

If all DALI operating devices of the DALI system concerned were switched off during the running time, the object value of the standby switch-off subsequently switches to "OFF". In this case, the telegram to the actuator disconnects all DALI operating devices (but not the gateway!) from the mains, thus saving electrical energy. Switching off the mains voltage can be delayed after transmitting the last DALI command to switch off the groups or single devices by the "Switch-off delay" parameter. This delay is useful, for example, if the DALI system is to be prevented from being switched off prematurely in the event of frequent changes to the state of the brightness values. Only when the brightness state has been 0% for a while can the operating devices also be disconnected from the mains.

The mains voltage is switched on automatically by the "ON" status telegram of the standby switch-off as soon as the gateway is to switch on at least one operating device by means of a DALI command. The time between the transmission of this status (switching on the mains voltage) and the transmission of the DALI command can be delayed by the parameter "Delay DALI restart" (0...10 s). This gives the DALI operating devices sufficient time after the return of the mains voltage to initialise themselves in order to be able to react properly to the commands of the gateway.

- i** If, during the course of a delay, additional telegrams are received via KNX until the restart of the DALI devices, then only the most recently received telegram is forwarded to the DALI system after the delay time has elapsed.
- i** When using the delay until the restart of the DALI devices, ensure that the parameter "Behaviour after bus voltage return" (corresponds to the DALI power-on level) of a group or single device is configured as "Switch-off". This means that the affected devices do not switch-on directly when the mains voltage returns but only after they have received an appropriate DALI command from the gateway via the DALI cable.
- i** During a standby switch-off, the gateway does not evaluate any DALI error status of the projected operating devices.

- i** Observe the current carrying capacity of the KNX switching actuator integrated in the standby switch-off! If necessary, use additional installation contactors. We do not recommend using multiple actuator channels, because it is usually not possible to implement simultaneous switching of all the channels.

The status object of the standby switch-off always works with active transmission as soon as the status changes. The state is transmitted to the KNX after the bus/mains voltage returns or after an ETS programming operation if a device is switched on or off after resetting it. Optionally, the status of the standby switch-off can also be transmitted cyclically in addition to transmission when the object value changes. The "Cyclical transmission" parameter defines whether cyclical transmission is enabled or not. If enabled, the "Cycle time" parameter on the same parameter page defines the time for cyclical transmission.

8.7.2 Global switching status

When using the global switching status, a visualisation can be linked to the corresponding status object (1 bit) of the gateway, for example in order to indicate the collected switching state of a DALI system at a central point of a building.

If all DALI operating devices of the DALI system concerned have been switched off during the running time, the object value of the global switching status immediately switches to "OFF". The state of the switching status changes to "ON" as soon as the gateway has switched on at least one operating device by a DALI command. In contrast to the standby switch-off, no ON or OFF delays can be configured for the global switching status.

The status object of the global switching status always works with active transmission as soon as the status changes. The state is transmitted to the KNX after the bus/ mains voltage returns or after an ETS programming operation if a device is switched on or off after resetting it. Optionally, the global switching status can be transmitted cyclically in addition to transmission when the object value changes. The "Cyclical transmission" parameter defines whether cyclical transmission is enabled or not. If enabled, the "Cycle time" parameter on the same parameter page defines the time for cyclical transmission.

The transmission of the status telegram can optionally be delayed after the bus/ mains voltage returns, whereby the delay time is set globally for all status functions of the gateway together. If the delay after the bus/mains voltage returns is required, the parameter with the same name must be activated. Otherwise, the global switching status is transmitted without delay after a device reset.

8.7.3 Parameters for global switching status / standby switch-off

DALI system... -> General

Global status	no status global switching status Standby switch-off
<p>The gateway is able to perform a standby switch-off of the connected DALI operating devices to save electrical energy when the lighting is switched off. Alternatively, the gateway provides a function for global reporting of the switching status of all projected groups and single devices.</p> <p>The standby switch-off or the global switching status is a function across groups and single devices within a DALI system. This parameter defines whether the function is used as a standby switch-off or switching status. Depending on this setting, further parameters and a 1-bit communication object become visible.</p>	
Delay after bus/mains voltage return	Checkbox (yes/no)
<p>The transmission of the status telegram of the global switching status can optionally be delayed after the bus/mains voltage returns, whereby the delay time is set globally for all status functions of the gateway together. This parameter must be activated if the delay after the bus/mains voltage returns is required. Otherwise, the global switching status is transmitted without delay after a device reset.</p> <p>This parameter is available only when the global switching status is enabled.</p>	
Cyclical transmission	Checkbox (yes/no)
<p>Optionally, the status telegram of the standby switch-off or global switching status can be transmitted cyclically in addition to transmission in the event of a change. This parameter then defines whether cyclical transmission is enabled or not.</p> <p>This parameter is available only when standby switch-off is enabled or when the global switching status is enabled.</p>	
Cycle time	0...23 h 0...2...59 min 0...59 s
<p>At this point, the time for the cyclical transmission of the standby switch-off or global switching status is defined.</p> <p>This parameter is available only if cyclical transmission is enabled.</p>	

Switch-off delay	0...1...59 min 0...59 s
<p>If all DALI operating devices of the DALI system concerned were switched off during the running time, the object value of the standby switch-off subsequently switches to "OFF". In this case, the telegram to the actuator disconnects all DALI operating devices (but not the gateway!) from the mains, thus saving electrical energy. Switching off the mains voltage can be delayed after sending the last DALI command to switch off the groups or single devices with this parameter. This delay is useful, for example, if the DALI system is to be prevented from being switched off prematurely in the event of frequent changes to the state of the brightness values. Only when the brightness state has been 0% for a while can the operating devices also be disconnected from the mains.</p> <p>This parameter is available only if standby switch-off is enabled.</p>	

DALI restart delay	0...10...59 s
<p>The mains voltage is switched on automatically by the "ON" status telegram of the standby switch-off as soon as the gateway is to switch on at least one operating device by means of a DALI command. The time between sending this status (switching on the mains voltage) and sending the DALI command can be delayed by this parameter. This gives the DALI operating devices sufficient time after the return of the mains voltage to initialise themselves in order to be able to react properly to the commands of the gateway.</p> <p>This parameter is available only if standby switch-off is enabled.</p>	

8.7.4 Objects for global switching status / standby switch-off

Function	Name	Type	DPT	Flag
Standby switch-off	DALI system...	1-bit	1.001	C, R, -, T, A
<p>1-bit object for connecting a KNX switch actuator for the purpose of executing a standby switch-off of the controlled operating devices of a DALI system (switching the mains voltage supply of the operating devices off and on).</p> <p>This object is available only if the standby switch-off is configured.</p>				

Function	Name	Type	DPT	Flag
Global switching status	DALI system...	1-bit	1.001	C, R, -, T, A
<p>1-bit object for signalling the global switching status of all groups and single devices contained in a DALI system ("0" = all groups / single devices OFF, "1" = at least one group / one single device ON).</p> <p>This object is available only if the global switching status is configured.</p>				

8.8 Time and day of the week (timer function)

Introduction

The gateway has an internal clock that tracks the time of day and day of the week and provides the "Colour Transition Mode (CTM)" and "Human Centric Lighting (HCL)" functions. The above functions require the current time and day of the week to implement the daytime colour temperature and daytime colour gradients. In order for the time and day of the week to provide the internal functions correctly, it must be set cyclically via the KNX. A separate communication object is available for this purpose. The data format of this object can be configured.

- i** To ensure sufficient accuracy, we recommend setting the clock with a KNX telegram at least once a day. For this purpose, it is recommended that a master clock is present in the KNX installation that provides the time and day of the week according to the set data format.

The gateway accepts telegrams for setting the time and day of the week only if the information provided is valid according to the KNX specification. If information in the KNX telegram is marked as "invalid" or contains errors, the gateway does not evaluate the data concerned. In this case, the internal clock is considered not to be set. If the KNX telegram for setting the clock contains the information "all days", the gateway no longer evaluates a discrete weekday and executes all configured functions only cyclically every day according to the stored times.

- i** No times or days of the week are updated if the gateway has not yet received any or a valid KNX telegram to set the internal clock after initialisation (after the mains voltage returns or an ETS programming operation). In this case, the daytime colour temperature and daytime colour gradients have no function!
- i** The gateway can automatically trigger a read telegram after a reset by setting the "initialisation flag" (I flag) at the communication object "Weekday/time" or "Date/weekday/time". The linked KNX master clock then usually sends the current time with weekday back to the gateway in response to this telegram. In order for the master clock to respond, the "read flag" (R flag) must be set at the corresponding communication object.

Setting the data format for the time and day of the week

The parameter "Format for day of week and time" in the "General" parameter node specifies the data format for setting the internal clock for the gateway. This allows an adjustment to be made to the output of the KNX master clock used.

- Set the parameter to "3 bytes".
The communication object "Weekday/time" is available. The format of this object is defined on the older KNX DPT 10.001.
- Set the parameter to "8 bytes".
The communication object "Date/weekday/time" is available. The format of this object is defined on the modern KNX DPT 19.001.

- i** The clock of the gateway only needs information about the time and the current day of the week. The date contained in the KNX telegram according to the 8-byte format (DPT 19.001) is not relevant and is not evaluated when setting the clock.

8.8.1 Parameters for time and day of the week

General

Format for day of week and time	3-byte 8-byte
<p>The gateway has an internal clock that tracks the time of day and day of the week and provides the "Colour Transition Mode (CTM)" and "Human Centric Lighting (HCL)" functions. In order for the time and day of the week to provide the internal functions correctly, it must be set cyclically via the KNX. A separate communication object is available for this purpose. The data format of this object can be configured at this point.</p> <p>3-byte: The communication object "Weekday/time" is available. The format of this object is defined on the older KNX DPT 10.001.</p> <p>8-byte: The communication object "Date/weekday/time" is available. The format of this object is defined on the modern KNX DPT 19.001.</p>	

8.8.2 Objects for time and day of the week

Function	Name	Type	DPT	Flag
Weekday/time	Gateway - Input	3-byte	10.001	C, -, W, T, U, I
<p>3-byte object for setting the internal clock with a KNX telegram according to DPT 10.001.</p> <p>The gateway can automatically trigger a read telegram after a reset by setting the "initialisation flag" (I flag).</p> <p>This object is available only if the format for the day of the week and time is set to "3-byte".</p>				
Function	Name	Type	DPT	Flag
Date/Day of week/Time	Gateway - Input	8-byte	19.001	C, -, W, T, U, I
<p>8-byte object for setting the internal clock with a KNX telegram according to DPT 19.001. The gateway's clock only needs information about the time and the current day of the week. The date contained in the KNX telegram is not relevant and is not evaluated when setting the clock.</p> <p>The gateway can automatically trigger a read telegram after a reset by setting the "initialisation flag" (I flag).</p> <p>This object is available only if the format for the day of the week and time is set to "8-byte".</p>				

9 Description of group and device functions

9.1 Controlling the brightness

Settable brightness range

The settable brightness range of a group or single device can be limited by defining a lower and upper brightness value. The "Minimum brightness" and "Maximum brightness" parameters on the parameter page "DALI system... -> Configuration groups -> [x] Group name" or "DALI system... -> Configuration single devices -> [x] Device name" define the brightness values that are not undercut or exceeded when a brightness value is set or during a dimming process. In this way, the brightness of the controlled lamps of the DALI operating devices can be adapted individually – even to the brightness sensitivity of the human eye. The configured minimum brightness can be undershot only by switching off or when dimming up starting in the "OFF" state.

Furthermore, the brightness value, which is set for the DALI operating devices whenever switching on by means of the object "Switching - Setting" or "Central function... - Switching". The parameter "Switch-on brightness" defines this brightness separately for each group and each single device. The settable value is anywhere between the minimum and maximum brightness.

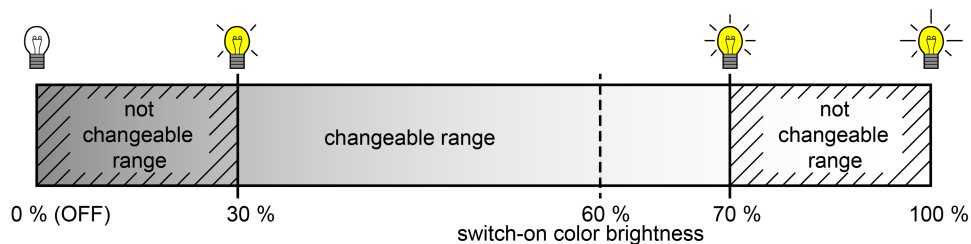

Figure 17: Example of a brightness range with switch-on brightness

Setting the minimum brightness

The minimum brightness can be set separately for each group and single device.

- Set the "Minimum brightness" parameter on the parameter page "DALI system... -> Configuration groups -> [x] Group name" or "DALI system... -> Configuration single devices -> [x] Device name" to the required brightness value.

The set brightness is not undershot when predefining a brightness value or during a dimming process in the "ON" state. The configured minimum brightness can be undershot during the dimming process only by switching off.

- i** The configured minimum brightness must be less than the maximum brightness.
- i** If values are received by means of the brightness value object and are less than the configured minimum brightness, the gateway sets the minimum brightness as the new brightness value for the group or single device concerned.

Setting the maximum brightness

The maximum brightness can be set separately for each group and single device.

- Set the "Maximum brightness" parameter on the parameter page "DALI system... -> Configuration groups -> [x] Group name" or "DALI system... -> Configuration single devices -> [x] Device name" to the required brightness value.

The set brightness is not undershot in any switched-on operating state.

- i** The configured maximum brightness must be greater than the minimum brightness.
- i** If values are received by means of the brightness value object and are greater than the configured maximum brightness, the gateway sets the maximum brightness as the new brightness value for the group or single device concerned.

Setting the switch-on brightness

The switch-on brightness can be set separately for each group and each single device.

- Set the "Switch-on brightness" parameter on the parameter page "DALI system... -> Configuration groups -> [x] Group name" or "DALI system... -> Configuration single devices -> [x] Device name" to a brightness value.

The set brightness is set after receiving an ON telegram by means of the communication object "Switching - Setting" or after receiving a central telegram with the polarity "activated".

- Set the parameter "Switch-on brightness" to "Memory value (brightness before switching off last time)".

When switching on, the brightness value is set that was active and internally stored before switching off the last time. This memory value is stored in a non-volatile manner in the gateway so that the value is retained after the bus or mains voltage returns. After an ETS programming operation, the memory value is predefined to "100%". This value is optionally limited by the maximum brightness.

- i** The switch-on brightness can always be configured within a range of 1...100%. If the switch-on brightness is outside the range defined by the minimum or maximum brightness, the gateway limits the switch-on brightness to the set limits.
- i** In the "memory value" setting: A memory value is stored internally by a switch-off telegram also if the bus-controlled switch-off is overridden, for example, by a disabling or forced position function or by a manual operation. In this case, the internally tracked brightness value is saved as memory value.

- i** If no soft ON function is activated, the brightness value is more or less jumped to when switching on (using minimum DALI fading of 0.7 s). Once a soft ON function is activated, the switch-on brightness is dimmed according to the dimming speed for the soft ON function.

Dimming characteristic and dimming speeds

The brightness of operating devices of a group or configured single device can be changed by a dimming process. The limits of the brightness range that can be set by a dimming process are defined by the maximum brightness and minimum brightness predefined in the ETS.

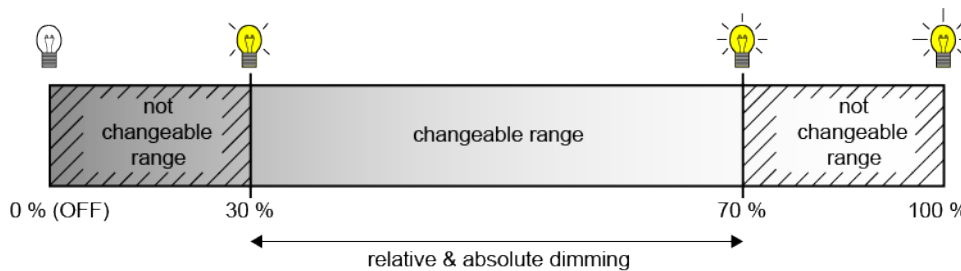

Figure 18: Example of a dimmable brightness range

A DALI group or single device can be dimmed by...

- **Relative dimming:**
Relative dimming can be triggered either by the 4-bit communication object "Dimming - Setting" available for each group or single device, additionally - in the event of colour temperature control - by the 3-byte combination object "Relative dimming (brightness and colour temperature) - Setting" or by pressing and holding a button of the manual control. The data format of the 4-bit object complies - as is normal with KNX dimming actuators - with the KNX DPT 3.007, which means that the dimming direction and relative dimming increments can be specified in the dimming telegram or dimming operations can also be stopped. The data format of the 3-byte object corresponds to KNX DPT 250.600, which enables combined relative dimming of brightness and colour temperature by means of separate dimming increments and dimming directions.
With relative dimming by local manual operation at the gateway, a dimming process is executed while the corresponding button is pressed. The dimming process ends when the button is released or when the maximum brightness or minimum brightness is reached. A relative dimming process allows a brightness value to be changed constantly and always starts from the brightness that is set at the time of the dimming command.
In the ETS, the dimming speed for relative dimming can be configured separately for each group or single device.
- **Absolute dimming:**
Absolute dimming is triggered by specifying a brightness value. This value can be triggered by the 1-byte communication object "Brightness value - Setting" present in each group or single device according to KNX DPT 5.001 or - in the case of colour temperature control - additionally by the 6-byte combination ob-

ject "Absolute dimming (brightness and colour temperature) - Setting" according to KNX DPT 249.600. In addition, brightness values can also be set by a disabling or forced position function or by the scene function. Absolute dimming can also be activated, even in case of bus voltage failure, after bus or mains voltage return or after programming with the ETS, by specifying brightness values.

When specifying a brightness value by means of the objects or by a scene recall in the ETS, it can be configured whether the value is jumped to directly or alternatively dimmed to over a dimming time or fading is carried out. When dimming by means of the 6-byte combination object, it is possible to specify an individual dimming time in the KNX telegram. If a valid time is specified there, the gateway executes the dimming time transmitted in the KNX telegram and not the one specified in the ETS. The brightness specified in the telegram value is then dimmed within the transmitted dimming time (fading). If the time is defined as "invalid" in the telegram, the gateway always executes the dimming behaviour defined in the ETS parameters during absolute dimming.

The setting of a dimming time for relative or absolute dimming (with dimming to the brightness values) is carried out within the range of minimum to maximum brightness at the gateway. The dimming times are derived directly from the configured times between two dimming steps.

- i** Even if brightness values are instantly jumped to, the dimming procedure on DALI operating devices always takes a very short time as well as when switching without soft ON or soft OFF. This dimming procedure is dependent on the system. The brightness value jumped to is dimmed to within 0.7 s (short fading). This time cannot be altered.

Setting dimming behaviour for absolute dimming

In the ETS, the dimming behaviour for absolute dimming can be set separately for each group and single device. The parameter "When receiving a brightness value" on the parameter page "DALI system... -> Configuration groups -> [x] Group name" or "DALI system... -> Configuration single devices -> [x] Device name" defines the behaviour.

- Set the parameter to "jumping to".
As soon as a new brightness value is specified, it is instantly jumped to.
- Set the "dimming to" parameter.
Once a new brightness value is specified, it is set by means of the configured dimming increment time for absolute dimming.
- Set the "fading" parameter. Configure the duration of the dimming process for the parameter "Time for brightness value via fading".
As soon as a new brightness value is specified, it is set by means of the configured fading time for absolute dimming. The dimming process then always takes exactly the set time, regardless of the initial value of the dimming process.

- i** During a scene recall, the dimming behaviour can be configured separately.

Setting dimming time for relative dimming

In the ETS, the dimming time for relative dimming can be set separately for each group or single device.

- Set the parameter "Time between two dimming steps for relative dimming" on the parameter page "DALI system... -> Configuration groups -> [x] Group name" or "DALI system... -> Configuration single devices -> [x] Device name" to the required dimming step time.

- i** The entire brightness range of 0...100% is divided into 255 dimming steps. The duration of a complete relative dimming process within this brightness range is calculated according to the formula: $t = 255 \times \text{time between two dimming steps [ms]}$. The actual dimmable range is limited by the configured minimum and maximum brightness.

Setting dimming time for absolute dimming

In the ETS, the dimming time for absolute dimming can be set separately for each group and single device.

The dimming behaviour must be configured as "dimming to".

- Set the "Time between two dimming steps for absolute dimming" parameter on the parameter page "DALI system... -> Configuration groups -> [x] Group name" or "DALI system... -> Configuration single devices -> [x] Device name" to the required dimming time.

- i** The entire brightness range of 0...100% is divided into 255 dimming steps. The duration of a complete absolute dimming process within this brightness range is calculated with the formula: $t = 255 \times \text{time between two dimming steps [ms]}$. The actual dimmable range is limited by the configured minimum and maximum brightness.

Setting dimming behaviour in OFF state for relative dimming

A relative dimming telegram for controlling the brightness can also switch on a group or single device in the "OFF" state. In the ETS, the behaviour in the "OFF" state when receiving a relative dimming telegram can be set separately for each group and each single device by the parameter "With relative dimming up in the switched-off state".

- Set the parameter to "Switch-on".
The group or single device is switched on in the "OFF" state by a relative brightness dimming telegram and carries out the dimming process. After reaching the intended brightness, the dimming process stops.
- Set the parameter to "No reaction".
The group or single device in the "OFF" state is not switched on by the relative dimming telegram. The group or single device remains switched off.

9.1.1 Dimming characteristic curves

The gateway converts KNX brightness values and brightness values configured in the ETS into DALI brightness values. On the DALI page, the brightness commands are transmitted in an 8-bit data value to the operating devices. This data value according to IEC 62386-102 is referred to as "Arc Power Level (APL)" in the DALI specification. The ideally dimmable brightness range on the DALI page is represented in the data value by the decimal values 1...254. The value "0" is interpreted by the operating devices as "OFF". A value "255" means "no change of brightness" ("MASK").

The DALI specification also describes a logarithmic dimming characteristic. This characteristic curve determines how the 8-bit data value is converted by operating devices (e.g. electronic ballast for fluorescent lamps or LED drivers) into an equivalent luminous flux at the physical output via the connected lamp. The luminous flux (physical device "Lumen [lm]") is a measure for the light output emitted by a lamp. The dimming characteristic curve of the operating devices maps the 8-bit data values transmitted logarithmically on the DALI page onto the luminous flux within the range of 1...254. This range then corresponds to a physical light output of 0.1...100 %.

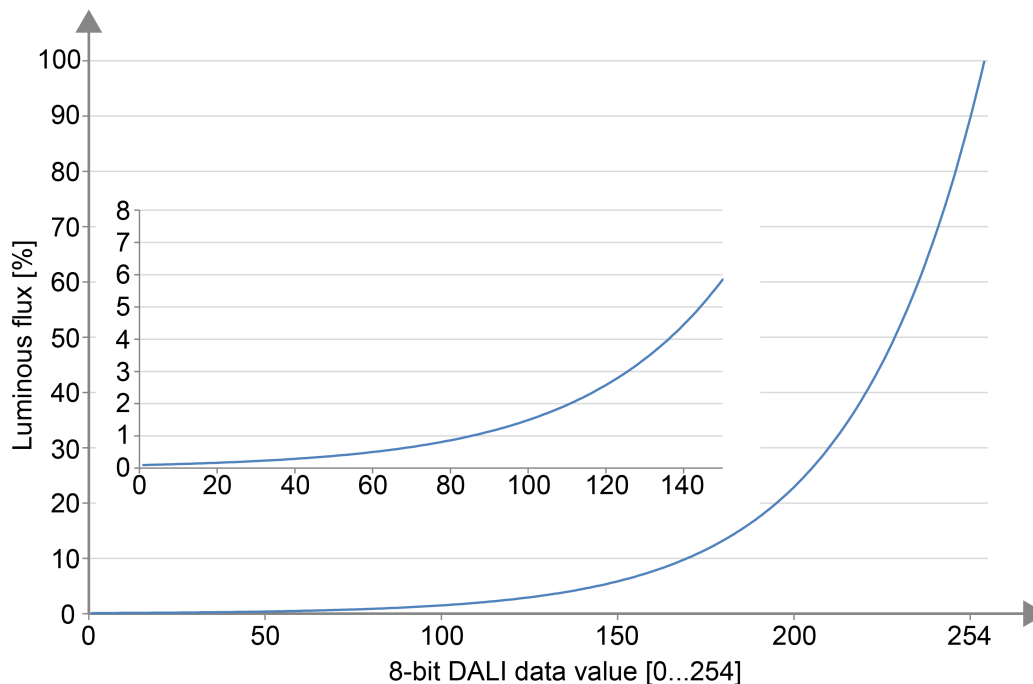

Figure 19: Logarithmic dimming curve in DALI operating devices (relative luminous flux [%] depending on the 8-bit DALI data value [0...254])

The logarithmic representation of the dimming values in the characteristic is used to adapt the emitted luminous flux to the subjective brightness sensitivity of the human eye. The human eye already perceives a far greater brightness at a luminous flux of 50 % (the lamp emits half of its light output into the surrounding space). Brightness changes in the upper physically possible dimming range (> 50 % luminous flux) are usually hardly perceived by the eye anymore.

By using a logarithmic characteristic curve, the dimming range of the DALI data value is mapped in large parts onto an area of the relative luminous flux where the human eye can optimally perceive brightness changes.

- i** The actual brightness range that can be dimmed by a DALI operating device does not always have to correspond to the maximum possible DALI dimming range (0.1...100 %). On a DALI operating device, the least adjustable brightness is referred to as the "physical minimum level (PHM)". This lower brightness limit value is defined by the physical properties of the operating device or connected lamp and is normally specified in the manufacturer's datasheet. The lower physical brightness limit value of an assigned operating device is independent of the adjustable minimum brightness. It is quite possible to set a lower minimum brightness (e.g. 0.1 %) in the ETS than an operating device can actually set as a minimum (e.g. 3 %). In such cases, the gateway dims to the configured minimum brightness via the DALI data value. The operating device or lamp then already stops at the physical minimum, however. Ideally, the minimum brightness of a group or single device is configured to the physical minimum of the operating device.
- i** A logarithmic dimming characteristic is standard in DALI operating devices and can normally be found in the delivery state. However, there are some operating devices, in which the characteristic curve can be adjusted - often by manufacturer-specific software tools. As a rule, it is possible to switch between a linear characteristic and a logarithmic characteristic. Such operating devices must always be set to a logarithmic characteristic curve in conjunction with the gateway! Otherwise, the mechanism of the configurable characteristic curves of the gateway will be incorrect!

When dimming, the logarithmic characteristic curve provided for DALI is not ideal for every control task. For this reason, the gateway allows the DALI dimming characteristic curve to be influenced for absolute dimming without having to intervene in the operating devices. The parameter "Characteristic curve in the value range" is available for this purpose on the parameter page "DALI system... -> Configuration groups -> [x] Group name -> Dimming characteristic" or "DALI system... -> Configuration single devices -> [x] Device name -> Dimming characteristic" for each group and single device in the ETS.

- i** The dimming characteristic curve within the time range (relative dimming) is always linear.

9.1.1.1 Linear dimming characteristic

In this setting, the gateway linearises the DALI dimming characteristic by converting all brightness values, which are received from the KNX and configured in the ETS, appropriately into DALI data values. Thus, the KNX brightness values form linearly on the luminous flux emitted by the DALI lamp. The gateway itself does not dim linearly in this setting. A linear dimming sequence of the relative luminous flux first results at the physical output of an operating device through the combination of the non-linear conversion of the gateway and the logarithmic characteristic of the operating devices.

Status telegrams of the brightness value are also adjusted by conversion. On account of the internal calculation process, there may be slight deviations between the specified and fed back brightness value (e.g. specification = 50 % -> Feedback = 49

%).

Example of brightness change:

KNX brightness: 50 % -> DALI data value (APL): 229 -> luminous flux: approx. 50 %
-> The human eye already perceives intense brightness.

KNX brightness: 75 % -> DALI data value (APL): 243 -> luminous flux: approx. 75 %
-> The human eye hardly perceives the brightness difference to the previous dimming setting anymore. The dimming process appears unsteady.

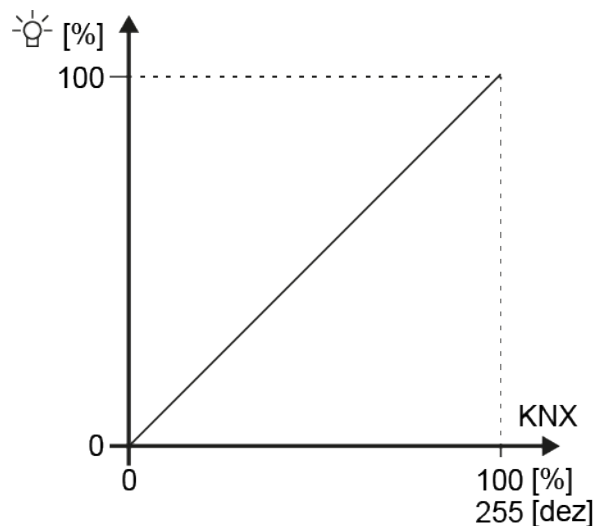

Figure 20: Linear dimming characteristic curve at the output of an operating device (relative luminous flux [%] depending on the 8-bit KNX data value [0...255])

KNX brightness value	KNX brightness value [%]	DALI value (APL)	Luminous flux [%]
0	0	0	0
1	0.4	27	0.2
10	4	136	4
50	20	194	19
80	32	212	32
100	40	220	40
128	50	229	50
150	60	235	60
175	70	240	68
200	80	245	78
225	90	249	87
255	100	254	100

Table 3: Transmission of data values with a linear dimming characteristic curve

Advantages of a linear DALI dimming characteristic:

Adjustment to existing KNX actuators possible. KNX dimming actuators or 1-10-V control units normally convert brightness values linearly into a physical output signal as defined in the KNX specification "Scaling" (DPT 5.001 / 0...255 -> 0.4...100 %). If a DALI system with such KNX actuators is combined in an installation, it is normally

necessary to set a linear dimming characteristic in the DALI gateway in order to adapt the dimming behaviour to the other actuators. Otherwise, the lamp will dim to a different brightness with identical KNX data values.

A linear dimming characteristic also has a positive effect on a multichannel RGB colour control, especially during dynamic colour changes (e.g. control of 3 different DALI channels for RGB colour mixing). By converting the KNX data values to a linear luminous flux for each primary colour, colours can be mixed reliably in a wide spectrum by the lamps.

In the event of operating devices with a high physical minimum brightness (> 3%) and thus a limited luminous flux range, a linear characteristic curve allows the possible KNX brightness range (0.4...100%) to be utilised usefully in the lower dimming range due to the increased DALI data values.

Disadvantages of a linear DALI dimming characteristic:

Dimming operations are not adjusted to the brightness perception of the human eye. This means that the dimming behaviour for mere brightness control is perceived as uneven due to the logarithmic human perception.

9.1.1.2 Logarithmic dimming characteristic curve

In this setting, the gateway forwards KNX brightness values unprocessed to the DALI page. A logarithmic dimming sequence of the relative luminous flux results at the physical output of an operating device through the combination of forwarding the value of the gateway and the logarithmic characteristic of the operating devices. KNX status telegrams of the effective DALI brightness value are possible in this case too.

Example of brightness change:

KNX brightness: 50 % -> DALI data value (APL): 128 -> Luminous flux: approx. 3 %
-> The human eye subjectively perceives about half of the lamp brightness.

KNX brightness: 75 % -> DALI data value (APL): 191 -> Luminous flux: approx. 18 %
-> The human eye clearly perceives a brightness difference to the previous dimming setting. The dimming process is constantly effective.

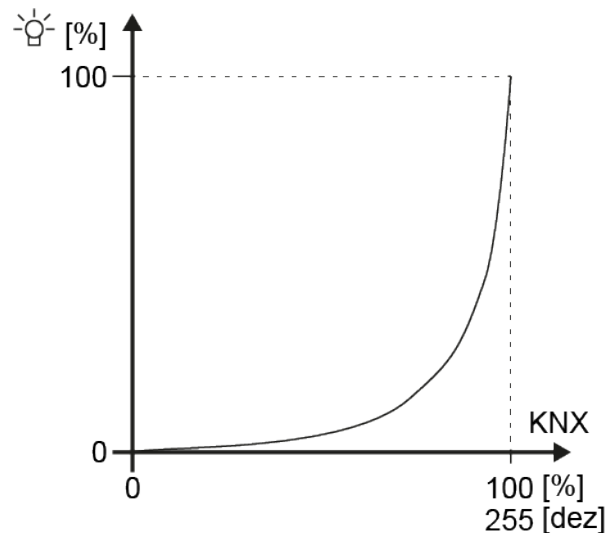

Figure 21: Logarithmic dimming characteristic curve at the output of an operating device
(relative luminous flux [%] depending on the 8-bit KNX data value [0...255])

KNX brightness value	KNX brightness value [%]	DALI value (APL)	Luminous flux [%]
0	0	0	0
1	0.4	1	0.1
10	4	10	0.13
50	20	50	0.38
80	32	80	0.86
100	40	100	1.5
128	50	128	3.2
150	60	150	5.8
175	70	175	12
200	80	200	23
225	90	225	45
255	100	254	100

Table 4: Transmission of data values in the event of a logarithmic dimming characteristic curve

Advantages of a logarithmic DALI dimming characteristic:

Ideal for pure brightness controls. Adjustment to the brightness perception of the human eye. As a result, brightness changes are perceived evenly in the entire dimming range. Fine number of levels in the lower dimming range.

Disadvantages of a logarithmic DALI dimming characteristic:

Difficult or even no adjustment at all at other KNX actuators that only dim linearly. Poor sliding progression when mixing colours via separate DALI channels. In the event of operating devices with a high physical minimum brightness (> 3%) and thus a limited luminous flux range, the lower KNX dimming range (0.4...50 %) cannot be utilised.

9.1.1.3 Combined dimming characteristic curve

This setting corresponds to a combination of linear and logarithmic dimming characteristic curve. The gateway converts KNX brightness values into suitable DALI dimming values, but not as intensively as with linearisation of the characteristic curve. The combination of a less severe value adjustment and the logarithmic dimming characteristic curve of the DALI operating devices results in a curved characteristic curve of the relative luminous flux at the physical output of an operating device with a less severe gradient especially in the upper dimming range. KNX status telegrams of the effective DALI brightness value are possible in this case too.

Example of brightness change:

KNX brightness: 50% -> DALI data value (APL): 147 -> Luminous flux: approx. 5.4%
-> The human eye subjectively perceives about slightly more than half of the lamp brightness.

KNX brightness: 75 % -> DALI data value (APL): 224 -> Luminous flux: approx. 44%
-> The human eye clearly perceives a brightness difference to the previous dimming setting, however it is not very intensive. However, the dimming process may still be continuous, depending on the lamp.

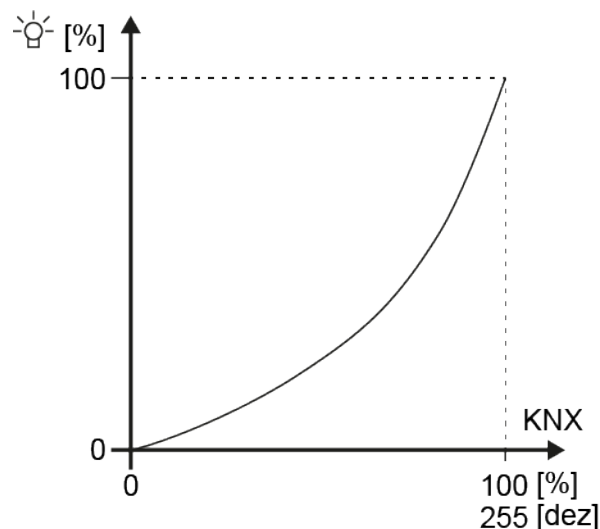

Figure 22: Combined dimming characteristic curve at the output of an operating device

(relative luminous flux [%] depending on the 8-bit KNX data value [0...255])

KNX brightness value	KNX brightness value [%]	DALI value (APL)	Luminous flux [%]
0	0	0	0
1	0.4	41	0.3
10	4	100	1.5
50	20	147	5.4
80	32	166	9
100	40	179	13
128	50	195	20

KNX brightness value	KNX brightness value [%]	DALI value (APL)	Luminous flux [%]
150	60	205	26
175	70	217	36
200	80	228	49
225	90	242	72
255	100	254	100

Table 5: Transmission of data values with a combined dimming characteristic curve

The combined dimming characteristic curve is a compromise between linearisation and adjustment to the subjective brightness perception of the human eye. It can be used as an alternative to the linear or logarithmic characteristic curve if the dimming behaviour of a lamp does not meet the user's requirements when using the other two dimming characteristic curves.

9.1.2 Parameters for brightness

DALI system... -> Configuration groups -> [x] Group name

DALI system... -> Configuration of single devices -> [x] Device name

Minimum brightness	1%, 2%, 3%, 4%, 5%, 6%, 7%, 8%, 9%, 10%, 15%, 20%...50%...100%
<p>The settable brightness range of a group or single device can be limited by defining a lower and upper brightness value. This parameter defines the lower brightness value, which is not undercut in any operating state of the gateway. In this way, the lower brightness of the controlled lamps of the DALI operating devices can be limited individually and adapted to the respective application.</p> <p>The set brightness is not undershot when predefining a brightness value or during a dimming process in the "ON" state. The configured minimum brightness can be undershot during the dimming process only by switching off or when dimming up starting in the "OFF" state.</p> <p>The configured minimum brightness must be less than the maximum brightness.</p>	
Maximum brightness	1%, 2%, 3%, 4%, 5%, 6%, 7%, 8%, 9%, 10%, 15%, 20%...50%...100%
<p>The settable brightness range of a group or single device can be limited by defining a lower and upper brightness value. This parameter sets the upper brightness value, which is not exceeded in any operating state of the gateway. In this way, the upper brightness of the controlled lamps of the DALI operating devices can be limited individually and adjusted to the respective application.</p> <p>The configured maximum brightness must be greater than the minimum brightness.</p>	

Switch-on brightness	1%, 2%, 3%, 4%, 5%, 6%, 7%, 8%, 9%, 10%, 15%, 20%...50%...100% Memory value (brightness like before the last switch-off)
<p>At this point, the brightness value can be specified that is set when the device is switched on.</p> <p>Brightness value: The set brightness is set when receiving an ON telegram via the communication object "Switching - Setting" or when receiving a central telegram with the polarity "activated".</p> <p>Memory value (brightness as before switching off the last time): When switching on, the brightness value is set that was active and stored internally before switching off the last time. This memory value is stored in a non-volatile manner in the gateway so that the value is retained after the bus or mains voltage returns. After an ETS programming operation, the memory value is predefined to "100%". This value is optionally limited by the maximum brightness.</p>	
On receipt of a brightness value	jumping to dimming to fading
<p>This parameter defines the dimming behaviour for absolute dimming using the object "Colour temperature - Setting" for a group or single device.</p> <p>jumping to: As soon as a new brightness value is specified, it is instantly jumped to. Even if brightness values are instantly jumped to, the dimming procedure on DALI operating devices always takes a very short time as well as when switching without soft ON or soft OFF. This dimming procedure is dependent on the system. The brightness value jumped to is dimmed to within 0.7 s (short fading). This time cannot be altered.</p> <p>dimming to: As soon as a new brightness value is specified, it is set by means of the configured dimming increment time for absolute dimming.</p> <p>fading: As soon as a new brightness value is specified, it is set by means of the configured fading time for absolute dimming. The dimming process then always takes exactly the set time, regardless of the initial value of the dimming process.</p>	

Time between two dimming steps for absolute dimming	1... 25 ...255 ms
<p>Absolute dimming is triggered by specifying a brightness value. This value can be triggered by the 1-byte communication object "Brightness value - Setting" present in each group or single device according to KNX DPT 5.001 or - in the case of colour temperature control - additionally by the 6-byte combination object "Absolute dimming (brightness and colour temperature) - Setting" according to KNX DPT 249.600.</p> <p>The dimming speed for absolute dimming of the brightness can be configured here.</p> <p>The entire brightness range of 0...100% is divided into 255 dimming steps. The duration of a complete absolute dimming process within this brightness range is calculated with the formula: $t = 255 \times \text{time between two dimming steps [ms]}$. The actual dimmable range is limited by the configured minimum and maximum brightness.</p> <p>This parameter is available only in the setting "On receipt of a brightness value = dimming to".</p>	
Time for colour temperature value via fading	0.. 20 ...240 s
<p>Setting the fading time for absolute dimming.</p> <p>This parameter is available only in the setting "On receipt of a brightness value = fading".</p>	
Time between two dimming steps for relative dimming	1... 25 ...255 ms
<p>Relative dimming can be triggered either by the 4-bit communication object "Dimming - Setting" available for each group or single device, additionally - in the event of colour temperature control - by the 3-byte combination object "Relative dimming (brightness and colour temperature) - Setting" or by pressing and holding a button of the manual control.</p> <p>The dimming speed for relative dimming of the brightness can be configured here.</p> <p>The entire brightness range of 0...100% is divided into 255 dimming steps. The duration of a complete relative dimming process within this brightness range is calculated according to the formula: $t = 255 \times \text{time between two dimming steps [ms]}$. The actual dimmable range is limited by the configured minimum and maximum brightness.</p>	
With relative dimming up in the switched-off state	switch-on no reaction
<p>A relative dimming telegram for controlling the brightness can also switch on a group or single device in the "OFF" state.</p> <p>Switch-on: The group or single device is switched on in the "OFF" state by a relative dimming telegram for the brightness and carries out the dimming process. After reaching the intended brightness, the dimming process stops.</p> <p>No reaction: The group or the single device in the "OFF" state is not switched on by the relative dimming telegram. The group or single device remains switched off.</p>	

DALI system... -> Configuration groups -> [x] Group name -> Dimming characteristic

DALI system... -> Configuration single devices -> [x] Device name -> Dimming characteristic

Characteristic curve in the value range	linear function logarithmic function combined function
<p>Setting the characteristic curve in the value range allows the 256 dimming steps possible on KNX to be adapted to the perception of the human eye. If this parameter is changed, the curve of the characteristic curve is shown in the diagram below. The choice of characteristic curve depends on the controlled operating device and the connected lamp.</p> <p>Linear function: In this setting, the gateway linearises the DALI dimming characteristic curve by converting all brightness values received from the KNX and projected in the ETS, appropriately into DALI data values. Thus, the KNX brightness values form linearly on the luminous flux emitted by the DALI lamps. The gateway itself does not dim linearly in this setting. A linear dimming sequence of the relative luminous flux first results at the physical output of an operating device through the combination of the non-linear conversion of the gateway and the logarithmic characteristic of the operating devices. Status telegrams of the brightness value are also adjusted by conversion. On account of the internal calculation process, there may be slight deviations between the specified and fed back brightness value (e.g. specification = 50 % -> Feedback = 49 %).</p> <p>Logarithmic function: In this setting, the gateway forwards KNX brightness values unprocessed on the DALI page. A logarithmic dimming sequence of the relative luminous flux results at the physical output of an operating device through the combination of forwarding the value of the gateway and the logarithmic characteristic of the operating devices. KNX status telegrams of the effective DALI brightness value are possible in this case too.</p> <p>Combined function: This setting corresponds to a combination of linear and logarithmic dimming characteristic curve. The gateway converts KNX brightness values into suitable DALI dimming values, but not as intensively as with linearisation of the characteristic curve. The combination of a less severe value adjustment and the logarithmic dimming characteristic curve of the DALI operating devices results in a curved characteristic curve of the relative luminous flux at the physical output of an operating device with a less severe gradient especially in the upper dimming range. KNX status telegrams of the effective DALI brightness value are possible in this case too.</p>	

9.1.3 Objects for brightness

Function	Name	Type	DPT	Flag
Switching - Setting	Group 1...32 / Single device 1...64	1-bit	1.001	C, -, W, -, U

1-bit object for switching the group or single device.

Function	Name	Type	DPT	Flag
Dimming - Default	Group 1...32 / Single device 1...64	4-bit	3.007	C, -, W, -, U

4-bit object for relative dimming of the brightness of the group or single device.

Function	Name	Type	DPT	Flag
Brightness value - Setting	Group 1...32 / Single device 1...64	1-byte	5.001	C, -, W, -, U

1-byte object for specifying an absolute brightness value within the limits of the minimum to maximum brightness.

Function	Name	Type	DPT	Flag
Relative dimming (brightness value and colour temperature) - Setting	Group 1...32 / Single device 1...64	3-byte	250.600	C, -, W, -, U

3-byte object for the combined relative dimming of the brightness and colour temperature by means of separate dimming increments and dimming directions.
This object is available only in the "Colour temperature control" function range.

Function	Name	Type	DPT	Flag
Absolute dimming (brightness value and colour temperature) - Setting	Group 1...32 / Single device 1...64	6-byte	249.600	C, -, W, -, U

6-byte object for the combined absolute dimming of the brightness and colour temperature by means of separate dimming values and for the specification of a dimming time.
When dimming by means of the 6-byte combination object, it is possible to specify an individual dimming time in the KNX telegram. If a valid time is specified there, the gateway executes the dimming time transmitted in the KNX telegram and not the one specified in the ETS. The colour temperature and brightness specified in the telegram value is then dimmed to within the transmitted dimming time (fading). If the time is defined as "invalid" in the telegram, the gateway always executes the dimming behaviour defined in the ETS parameters during absolute dimming.
This object is available only in the "Colour temperature control" function range.

9.2 Controlling the colour temperature

Settable colour temperature range

When controlling DALI operating devices that support the device type "DT8 - Tunable White", the colour temperature of the connected lamps can be changed. The settable colour temperature range of a group or single device can be limited by defining a lower and upper colour temperature value. The "Minimum colour temperature" and "Maximum colour temperature" parameters in the parameter node "DALI system... -> Configuration groups -> [x] Group name -> Colour temperature" or "DALI system... -> Configuration single devices -> [x] Device name -> Colour temperature" define the colour temperature values that are not undercut or exceeded in any operating state of the gateway. In this way, the colour temperature of the controlled lamps of the DALI operating devices can be limited individually and adapted to the respective application.

In addition, the colour temperature value can be specified that is set when the device is switched on. The "Switch-on colour temperature" parameter defines this colour temperature value separately for each group and single device.

- i** The switch-on colour temperature as a value specification can be configured basically within a range of 1,000...10,000 K. If the switch-on colour temperature is outside the range defined by the minimum or maximum colour temperature, the gateway limits the switch-on colour temperature to the defined limits.

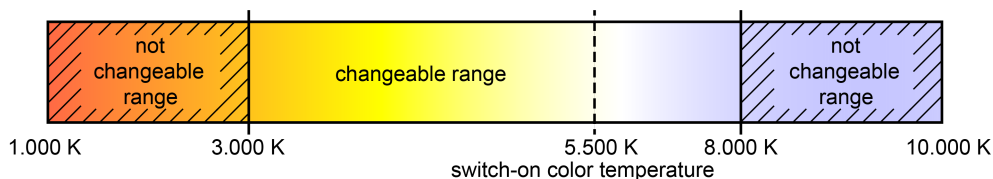

Figure 23: Example of a configured colour temperature range with switch-on colour temperature

- i** DALI luminaires that can change the colour temperature are usually fitted with two different lamps for warm white and cold white light. The luminous flux of both lamps can be varied independently and thus the colour temperature changed within the specified range by varying control by the upstream DALI operating device (e.g. DALI DT8 LED driver). In the lower colour temperature range, only the warm white lamp is usually switched on. In the upper colour temperature range, only the cold white is switched on. A DALI operating device according to DALI device type 8 essentially changes the proportional luminous flux of the lamp while maintaining the total luminous flux that is specified by the brightness of the DALI group or single device. During a dimming process of the colour temperature, the operating devices may switch the lamps on or off as required. This can lead to switching process within the transition ranges that cause the colour temperature dimming processes to briefly appear unsteady.

Setting minimum colour temperature

The minimum colour temperature can be set separately for each group and single device.

- Set the "Minimum colour temperature" parameter on the parameter page "DALI system... -> Configuration groups -> [x] Group name -> Colour temperature" or "DALI system... -> Configuration single devices -> [x] Device name -> Colour temperature" to the required colour temperature.

The set colour temperature is not undershot in any operating state.

- i** The configured minimum colour temperature must be lower than the maximum colour temperature.
- i** If an absolute colour temperature is received by the KNX that is less than the configured minimum colour temperature, the gateway will set the minimum colour temperature as the new colour temperature value for the group or single device concerned. In this case, the "colour temperature invalid" status can be generated optionally.

Setting the maximum colour temperature

The maximum colour temperature can be set separately for each group and single device.

- Set the "Maximum colour temperature" parameter on the parameter page "DALI system... -> Configuration groups -> [x] Group name -> Colour temperature" or "DALI system... -> Configuration single devices -> [x] Device name -> Colour temperature" to the required colour temperature.

The colour temperature set is not exceeded in any switched-on operating state.

- i** The configured maximum colour temperature must be greater than the minimum colour temperature.
- i** If an absolute colour temperature is received by the KNX that is higher than the configured maximum colour temperature, the gateway will set the maximum colour temperature as the new colour temperature value for the group or single device concerned. In this case, the "colour temperature invalid" status can be generated optionally.

Setting the switch-on colour temperature

The switch-on colour temperature can be set separately for each group and single device. The "Switch-on colour temperature" parameter on the parameter page "DALI system... -> Configuration groups -> [x] Group name -> Colour temperature" or "DALI system... -> Configuration single devices -> [x] Device name -> Colour temperature" defines the behaviour.

- Set the parameter to "Track".

When switching on, the internally tracked colour temperature most recently specified and in the "Brightness 0%" state is preset. The tracked colour temperature value is not influenced by an ETS programming operation or by a bus voltage failure ("no change"). When the bus/mains voltage returns, the colour temperature active most recently before the bus/mains voltage failure is restored. Hence, this colour temperature is taken into account as a colour temperature value to be tracked when switching on. As long as no colour temperature value could be tracked yet, the default value is "2,700 K", which is optionally limited by the minimum or maximum colour temperature.

- Set the parameter to "preset". Perimeter the desired colour temperature value in the "Colour temperature" parameter.

The set colour temperature is set when receiving an ON telegram via the communication object "Switching - Setting" or when receiving a central telegram with the polarity "activated".

- Set the parameter to "memory value (value before the last switch-off)".

When switching on, the colour temperature is set that was active and stored internally before switching off the last time. This memory value is stored in a non-volatile manner in the gateway so that the value is retained after the bus or mains voltage returns. After an ETS programming operation, the memory colour temperature value is predefined to "2,700 K". This value is optionally limited by the minimum or maximum colour temperature.

- i** In the "preset" setting: The switch-on colour temperature can always be configured within a range of 1,000...10,000 K. If the switch-on colour temperature is outside the range defined by the minimum or maximum colour temperature, the gateway limits the switch-on colour temperature to the defined limits.
- i** In the "memory value" setting: A memory value is stored internally by a switch-off telegram also if the bus-controlled switch-off is overridden, for example, by a disabling or forced position function or by a manual operation. In this case, the internally tracked colour temperature value is saved as memory value.
- i** The colour temperature to be set by switching on is either dimmed in the configured dimming time or is jumped to directly depending on the configured dimming behaviour (absolute dimming). The dimming characteristic curve for colour temperature changes is always linear.

Dimming characteristic and dimming speeds

When activating DALI operating devices that support the device type "Tunable White" (DT8 - TW), the colour temperature can be changed by a relative or absolute dimming process. The limits of the colour temperature range adjustable by a dimming process is defined by the minimum and maximum colour temperature predefined in the ETS.

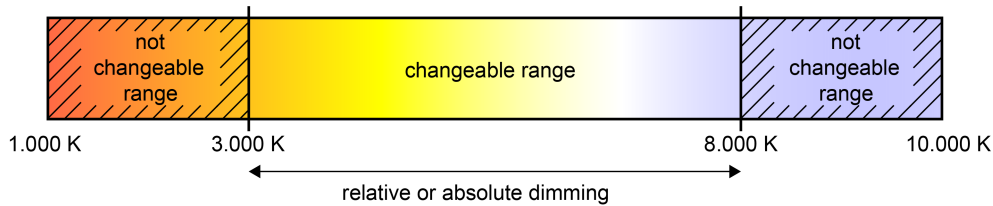

Figure 24: Example of a dimmable colour temperature range

A DALI group or single device can be dimmed by...

- **Relative dimming:**
Relative dimming of the colour temperature can be triggered either by the 4-bit communication object "Relative colour temperature - Setting" available for each group or single device or by the 3-byte combination object "Relative dimming (brightness and colour temperature) - Setting". As with relative dimming of the brightness, the data format of the 4-bit object complies with the KNX DPT 3.007, which means that the dimming direction and relative dimming increments can be specified in the dimming telegram or dimming processes can also be stopped. The data format of the 3-byte object corresponds to KNX DPT 250.600, which enables combined relative dimming of brightness and colour temperature by means of separate dimming increments and dimming directions. A relative dimming process allows a colour temperature value to be changed constantly and always starts from the colour temperature that is set at the time of the dimming command.
In the ETS, the dimming speed for relative dimming of the colour temperature can be configured for a brightness change separately for each group or single device and independently of the dimming speed.
A relative dimming telegram for controlling the colour temperature can also switch on a group or single device in the "OFF" state. In some applications, it may be necessary, however, for a switched off group or switched off device to still remain off until a relative dimming telegram of the colour temperature is received. This is interesting, for instance when using light scenes: Several DALI groups are set to a defined colour temperature by a light scene. Other groups are switched off by the scene. Only the colour temperature of channels not switched off by the scene recall should be changed by dimming up afterwards. Here, it is necessary for groups or single devices not to respond to relative dimming of the colour temperature and thus not to switch on. The parameter "Behaviour in switched off state when changing the colour temperature by relative dimming" defines whether a group or single device in the "OFF" state is switched by via a relative dimming telegram of the colour temperature or remains switched off and only tracks the dimming process internally.
- **Absolute dimming:**
Absolute dimming is triggered by specifying a colour temperature value. This value can be specified either by the 2-byte communication object "Absolute colour temperature - Setting" available in each group or single device according to KNX DPT 7.600 or by the 6-byte combination object "Absolute dimming (brightness and colour temperature) - Setting" according to KNX DPT 249.600 for the combined control of brightness and colour temperature. In addition, colour temperature values can also be set by the scene function.
When specifying a colour temperature value by the objects or by a scene call-

up, it can be configured in the ETS whether the value is jumped to directly or alternatively dimmed to over a dimming time or fading is carried out. When dimming by means of the 6-byte combination object, it is possible to specify an individual dimming time in the KNX telegram. If a valid time is specified there, the gateway executes the dimming time transmitted in the KNX telegram and not the one specified in the ETS. The colour temperature and brightness specified in the telegram value is then dimmed to within the transmitted dimming time (fading). If the time is defined as "invalid" in the telegram, the gateway always executes the dimming behaviour defined in the ETS parameters during absolute dimming.

Just as with relative dimming, an absolute dimming telegram for controlling the colour temperature can also switch on a group or single device in the "OFF" state. Here too, it may be necessary in some applications for a switched off group or switched off device to still remain off if a new colour temperature value is specified absolutely. The parameter "Behaviour in switched off state when changing the colour temperature by absolute dimming" defines whether a group or single device in the "OFF" state is switched on by a new absolute dimming telegram of the colour temperature or remains switched off and only tracks the colour temperature value internally.

A dimming time for relative dimming or absolute dimming (with dimming to the colour temperature values) is set at the gateway within the range from the minimum colour temperature to maximum colour temperature. The dimming times are derived directly from the configured times between two dimming steps.

- i** The dimming characteristic curve for colour temperature changes is always linear.
- i** Optionally, the 1-bit status object "Colour temperature invalid - Status" can be used to indicate whether an externally specified colour temperature is invalid. This is the case, if the specified colour temperature violates the set limits of the minimum and maximum colour temperature.
- i** The dimming of the colour temperature cannot be triggered by manual operation directly on site on the device.
- i** Even if colour temperature values are instantly jumped to, the dimming procedure on DALI operating devices always takes a very short time. This dimming procedure is dependent on the system. The colour temperature value jumped to will be dimmed to within 0.7 seconds (short fading). This time cannot be altered.

It is optionally possible to automatically change the colour temperature proportionally when dimming the brightness. This makes it possible with little project planning to simulate a thermal radiator using almost any colour temperature controllable lamp (perception of the light source such as an incandescent or halogen lamp).

Example:

A DALI luminaire is fitted with colour temperature controllable LED lamps. The luminaire is switched and its brightness dimmed by KNX telegrams. When dimming, the colour temperature should adjust automatically to the brightness of the dimming set-

ting without the colour temperature being specified separately via the KNX. At low brightness, the lamp should glow warm white, and at high brightness it should glow cold white. Thus, the colour temperature should change constantly in the same way as the brightness within the limits of the dimmable brightness range.

The maximum possible KNX brightness range (0...100 %) is mapped proportionally to the configured colour temperature range (minimum colour temperature [0%]...maximum colour temperature [100%]) during the automatic adjustment of the colour temperature. A configured minimum and maximum brightness limits the automatically adjustable colour temperature range. In the same way, a configured minimum colour temperature can never be undershot and a maximum colour temperature can never be exceeded even if the brightness range allows a greater adjustment range.

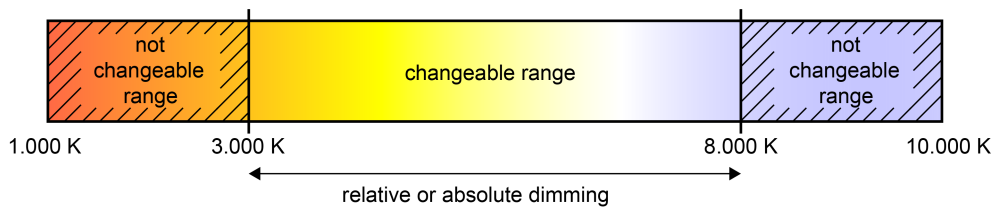

Figure 25: Automatic adjustment of the colour temperature to the set brightness
Example in the maximum brightness and colour temperature range

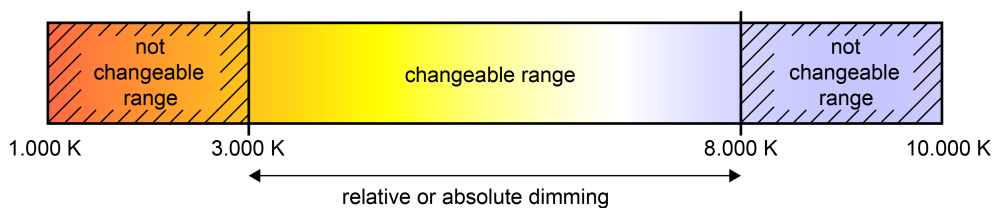

Figure 26: Automatic adjustment of the colour temperature to the set brightness
Example with limited brightness and colour temperature range

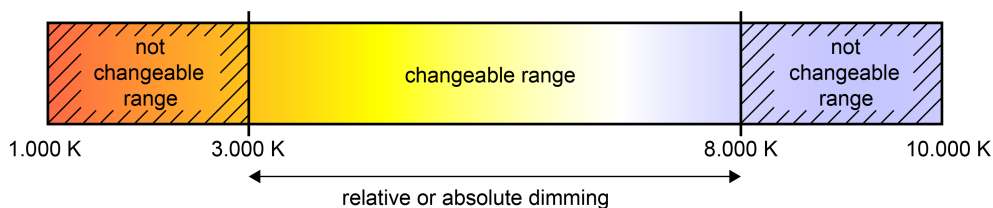

Figure 27: Automatic adjustment of the colour temperature to the set brightness
Example with limited colour temperature range

The colour temperature can be automatically adjusted to the brightness dimming setting of a DALI group or single device during relative dimming and absolute dimming. The parameters "Behaviour of the colour temperature when changing the brightness by relative dimming" and "Behaviour of the colour temperature when changing the brightness by absolute dimming" allow the described function for relative or absolute dimming to be activated separately.

- i** The brightness of the lamp connected to the physical output of the controlled DALI operating device is dimmed by the DALI characteristic curve configured in the ETS for each group or single device. The colour temperature is constantly dimmed linearly.

Setting dimming behaviour for absolute dimming

In the ETS, the dimming behaviour for absolute dimming can be set separately for each group and single device. The parameter "When receiving a colour temperature value" on the parameter page "DALI system... -> Configuration groups -> [x] Group name -> Colour temperature" or "DALI system... -> Configuration single devices -> [x] Device name -> Colour temperature" defines the behaviour.

- Set the parameter to "jumping to".
As soon as a new colour temperature value is specified, it is instantly jumped to.
- Set the "dimming to" parameter.
Once a new colour temperature value is specified, it is set by means of the configured dimming step time for absolute dimming.
- Set the "fading" parameter. Configure the duration of the dimming process for the parameter "Time for colour temperature via fading".
As soon as a new colour temperature value is specified, it is set by means of the configured fading time for absolute dimming. The dimming process then always takes exactly the set time, regardless of the initial value of the dimming process.

i During a scene recall, the dimming behaviour can be configured separately.

Setting dimming time for relative dimming

In the ETS, the dimming time for relative dimming of the colour temperature can be set separately for each group or each single device.

- Set the parameter "Time between two dimming steps for relative dimming" on the parameter page "DALI system... -> Configuration groups -> [x] Group name -> Colour temperature" or "DALI system... -> Configuration single devices -> [x] Device name -> Colour temperature" to set the required dimming step time.

i The relative dimming of the colour temperature always takes place within the range limited by the configured minimum and maximum colour temperature. This range is divided into 255 dimming steps. The duration of a complete dimming process within this colour temperature range is calculated with the formula: $t = 255 \times \text{time between two dimming steps [ms]}$.

Setting dimming time for absolute dimming

In the ETS, the dimming time for absolute dimming can be set separately for each group and single device.

The dimming behaviour must be configured as "dimming to".

- Set the "Time between two dimming steps for absolute dimming" parameter on the parameter page "DALI system... -> Configuration groups -> [x] Group name -> Colour temperature" or "DALI system... -> Configuration single devices -> [x] Device name -> Colour temperature" to set the required dimming time.

i The absolute dimming of the colour temperature always takes place within the range limited by the configured minimum and maximum colour temperature. This range is divided into 255 dimming steps. The duration of a complete dimming process within this colour temperature range is calculated with the formula: $t = 255 \times \text{time between two dimming steps [ms]}$.

Setting dimming behaviour in OFF state for absolute dimming

Absolute dimming of the colour temperature can also be switched on by a group or single device in the "OFF" state. In the ETS, the behaviour in the "OFF" state when receiving an absolute colour temperature telegram can be set separately for each group and single device by the parameter "Behaviour in switched-off state when changing the colour temperature by absolute dimming".

- Set the parameter to "Switch-on".

The group or single device in the "OFF" state is switched to the configured switch-on brightness by an absolute colour temperature telegram. The colour temperature is set to the colour temperature value received. If the dimming behaviour is configured to "jumping to", the intended colour temperature value is immediately preset.

If the dimming behaviour is configured to "dimming to", the dimming process starts at the colour temperature value most recently set by the gateway or which was tracked in the "OFF" state. The dimming process is executed according to the set dimming step time. The dimming process stops after reaching the specified colour temperature.

If the dimming behaviour is configured to "fading", the dimming process starts at the colour temperature value most recently set by the gateway or tracked in the "OFF" state. The dimming process is executed according to the set fading time. The dimming process then always takes exactly the set time, regardless of the initial value of the dimming process. The dimming process stops after reaching the specified colour temperature.
- Set the parameter to "No reaction".

The group or single device in the "OFF" state is not switched by the absolute colour temperature telegram. The group or single device remains switched off. The next time the device is switched on, the last colour temperature value received is tracked only if the "Switch-on colour temperature" parameter is configured to the "track" setting.

Setting dimming behaviour in OFF state for relative dimming

A relative dimming telegram for controlling the colour temperature can also switch on a group or single device in the "OFF" state. In the ETS, the behaviour in the "OFF" state when receiving a relative colour temperature telegram can be set separately for each group and each single device by the parameter "Behaviour in switched-off state when changing the colour temperature by relative dimming".

- Set the parameter to "Switch-on".
The group or single device is switched on in the "OFF" state by a relative dimming telegram of the colour temperature to the configured switch-on brightness. The colour temperature is set to the configured switch-on colour temperature. Based on this colour temperature state, the colour temperature to be dimmed is dimmed. The relative dimming telegram that leads to switching on, specifies the dimming direction and dimming increment. The dimming process stops after reaching the specified colour temperature.
- Set the parameter to "No reaction".
The group or single device in the "OFF" state is not switched on by the relative dimming telegram. The group or single device remains switched off. The next time the device is switched on, the colour temperature value dimmed last is tracked only if the "Switch-on colour temperature" parameter is configured to the "track" setting.

Setting the behaviour of the colour temperature when dimming the brightness

It is optionally possible to automatically change the colour temperature proportionally when dimming the brightness. This makes it possible with little project planning to simulate a thermal radiator using almost any colour temperature controllable lamp (perception of the light source such as an incandescent or halogen lamp). In the ETS, the behaviour of the colour temperature can be set separately by means of parameters for each group and single device for this application when dimming the brightness for relative or absolute dimming.

- Set the parameter "Behaviour of the colour temperature when changing the brightness by relative dimming" to "no change".
The relative dimming of the brightness by a 4-bit dimming telegram has no effect on the colour temperature of the group or single device. The colour temperature can be controlled only separately.
- Set the parameter "Behaviour of the colour temperature when changing the brightness by relative dimming" to "change proportional to brightness".
During relative dimming of the brightness with a 4-bit dimming telegram, the colour temperature of the group or single device is also changed proportionally. The colour temperature becomes warmer when dimming down. The colour temperature becomes colder when dimming up. The colour temperature can also be controlled separately.
- Set the parameter "Behaviour of the colour temperature when changing the brightness by absolute dimming" to "no change".

The absolute dimming of the brightness with a 1-byte brightness value has no effect on the colour temperature of the group or single device. The colour temperature can be controlled only separately.

- Set the parameter "Behaviour of the colour temperature when changing the brightness by absolute dimming" to "change proportional to brightness".

During absolute dimming of the brightness with a 1-byte brightness value, the colour temperature of the group or single device is also changed proportionally. The colour temperature becomes warmer when dimming down. The colour temperature becomes colder when dimming up. The colour temperature can also be controlled separately.

9.2.1 Parameters for colour temperature

DALI system... -> Configuration groups -> [x] Group name -> Colour temperature

DALI system... -> Configuration single devices -> [x] Device name -> Colour temperature

Minimum colour temperature	1,000... 2,000 ...10,000 K
<p>The settable colour temperature range of a group or single device can be limited by defining a lower and upper colour temperature value. This parameter defines the lower colour temperature value, which is not undercut in any operating state of the gateway. In this way, the lower colour temperature of the controlled lamps of the DALI operating devices can be limited individually and adapted to the respective application.</p> <p>The configured minimum colour temperature must be lower than the maximum colour temperature.</p>	

Maximum colour temperature	1,000... 6,000 ...10,000 K
<p>The settable colour temperature range of a group or single device can be limited by defining a lower and upper colour temperature value. This parameter defines the upper colour temperature value, which is not exceeded in any operating state of the gateway. In this way, the upper colour temperature of the controlled lamps of the DALI operating devices can be limited individually and adapted to the respective application.</p> <p>The configured maximum colour temperature must be greater than the minimum colour temperature.</p>	

Switch-on colour temperature	track preset memory value (value bef. switching-off last time)
<p>At this point, the colour temperature value can be specified that is set when the device is switched on.</p> <p>Track: When switching on, the internally tracked colour temperature most recently specified and in the "Brightness 0%" state is preset. The tracked colour temperature value is not influenced by an ETS programming operation or by a bus voltage failure ("no change"). When the bus/mains voltage returns, the colour temperature active most recently before the bus/mains voltage failure is restored. Hence, this colour temperature is taken into account as a colour temperature value to be tracked when switching on. As long as no colour temperature value could be tracked yet, the default value is "2,700 K", which is optionally limited by the minimum or maximum colour temperature.</p> <p>Preset: The set colour temperature is set when receiving an ON telegram via the communication object "Switching - Setting" or when receiving a central telegram with the polarity "activated".</p> <p>Memory value (value before the last switch-off): When switching on, the colour temperature is set that was active and stored internally before switching off the last time. This memory value is stored in a non-volatile manner in the gateway so that the value is retained after the bus or mains voltage returns. After an ETS programming operation, the memory colour temperature value is predefined to "2,700 K". This value is optionally limited by the minimum or maximum colour temperature.</p>	
Colour temperature	1,000... 2,700 ...10,000 K
<p>Setting of the switch-on colour temperature value.</p> <p>The switch-on colour temperature as a value specification can be configured basically within a range of 1,000...10,000 K. If the switch-on colour temperature is outside the range defined by the minimum or maximum colour temperature, the gateway limits the switch-on colour temperature to the defined limits.</p> <p>This parameter is available only in the setting "Switch-on colour temperature = preset".</p>	

When receiving a colour temperature value	jumping to dimming to fading
<p>This parameter defines the dimming behaviour for absolute dimming using the object "Colour temperature - Setting" for a group or single device.</p> <p>jumping to: As soon as a new colour temperature value is specified, it is instantly jumped to. Even if colour temperature values are instantly jumped to, the dimming procedure on DALI operating devices always takes a very short time. This dimming procedure is dependent on the system. The colour temperature value jumped to will be dimmed to within 0.7 seconds (short fading). This time cannot be altered.</p> <p>dimming to: Once a new colour temperature value is specified, it is set by means of the configured dimming step time for absolute dimming.</p> <p>fading: As soon as a new colour temperature value is specified, it is set by means of the configured fading time for absolute dimming. The dimming process then always takes exactly the set time, regardless of the initial value of the dimming process.</p>	
Time between two dimming steps for absolute dimming	1... 25 ...255 ms
<p>Absolute dimming is triggered by specifying a colour temperature value. This value can be specified either by the 2-byte communication object "Absolute colour temperature - Setting" available in each group or single device according to KNX DPT 7.600 or by the 6-byte combination object "Absolute dimming (brightness and colour temperature) - Setting" according to KNX DPT 249.600 for the combined control of brightness and colour temperature.</p> <p>The dimming speed for absolute dimming of the colour temperature can be configured here.</p> <p>The absolute dimming of the colour temperature always takes place within the range limited by the configured minimum and maximum colour temperature. This range is divided into 255 dimming steps. The duration of a complete dimming process within this colour temperature range is calculated with to the formula: $t = 255 \times \text{time between two dimming steps [ms]}$.</p> <p>This parameter is available only in the setting "When receiving a colour temperature value = dimming to".</p>	
Time for colour temperature value via fading	0.. 20 ...240 s
<p>Setting the fading time for absolute dimming.</p> <p>This parameter is available only in the setting "When receiving a colour temperature value = fading".</p>	

Time between two dimming steps for relative dimming	1... 25 ...255 ms
<p>Relative dimming of the colour temperature can be triggered either by the 4-bit communication object "Relative colour temperature - Setting" available for each group or single device or by the 3-byte combination object "Relative dimming (brightness and colour temperature) - Setting".</p> <p>The dimming speed for relative dimming of the colour temperature can be configured here.</p> <p>The relative dimming of the colour temperature always takes place within the range limited by the configured minimum and maximum colour temperature. This range is divided into 255 dimming steps. The duration of a complete dimming process within this colour temperature range is calculated with to the formula: $t = 255 \times \text{time between two dimming steps [ms]}$.</p>	
Behaviour in switched-off state when changing the colour temperature by absolute dimming	switch-on no reaction
<p>An absolute colour temperature telegram can also be switched on by a group or single device in the "OFF" state, with the behaviour set by this parameter.</p> <p>Switch-on: The group or single device in the "OFF" state is switched to the configured switch-on brightness by an absolute colour temperature telegram. The colour temperature is set to the colour temperature value received. If the dimming behaviour is configured to "jumping to", the intended colour temperature value is immediately preset. If the dimming behaviour is configured to "dimming to", the dimming process starts at the colour temperature value most recently set by the gateway or which was tracked in the "OFF" state. The dimming process is executed according to the set dimming step time. The dimming process stops after reaching the specified colour temperature. If the dimming behaviour is configured to "fading", the dimming process starts at the colour temperature value most recently set by the gateway or tracked in the "OFF" state. The dimming process is executed according to the set fading time. The dimming process then always takes exactly the set time, regardless of the initial value of the dimming process. The dimming process stops after reaching the specified colour temperature.</p> <p>No reaction: The group or single device in the "OFF" state is not switched by the absolute colour temperature telegram. The group or single device remains switched off. The next time the device is switched on, the last colour temperature value received is tracked only if the "Switch-on colour temperature" parameter is configured to the "track" setting.</p>	

Behaviour in switched-off state when changing the colour temperature by relative dimming	switch-on no reaction
<p>A relative colour temperature dimming telegram can also switch on a group or single device in the "OFF" state, with the behaviour set by this parameter.</p> <p>Switch-on: The group or single device in the "OFF" state is switched on to the configured switch-on brightness by a relative dimming telegram of the colour temperature. The colour temperature is set to the configured switch-on colour temperature. Based on this colour temperature state, the colour temperature to be dimmed is dimmed. The relative dimming telegram that leads to switching on, specifies the dimming direction and dimming increment. The dimming process stops after reaching the specified colour temperature.</p> <p>No reaction: The group or the single device in the "OFF" state is not switched on by the relative dimming telegram. The group or single device remains switched off. The next time the device is switched on, the colour temperature value dimmed last is tracked only if the "Switch-on colour temperature" parameter is configured to the "track" setting.</p>	

Behaviour of the colour temperature when changing the brightness by absolute dimming	change proportional to brightness No change
<p>It is optionally possible to automatically change the colour temperature proportionally when dimming the brightness. This makes it possible with little project planning to simulate a thermal radiator using almost any colour temperature controllable lamp (perception of the light source such as an incandescent or halogen lamp). This parameter can be used to set the behaviour of the colour temperature during absolute dimming of the brightness for the application mentioned.</p> <p>Change proportional to brightness: During absolute dimming of the brightness with a 1-byte brightness value, the colour temperature of the group or single device is also changed proportionally. The colour temperature becomes warmer when dimming down. The colour temperature becomes colder when dimming up. The colour temperature can also be controlled separately.</p> <p>No change: The absolute dimming of the brightness by a 1-byte brightness value has no effect on the colour temperature of the group or single device. The colour temperature can be controlled only separately.</p>	

Behaviour of the colour temperature when changing the brightness by relative dimming	change proportional to brightness No change
<p>It is optionally possible to automatically change the colour temperature proportionally when dimming the brightness. This makes it possible with little project planning to simulate a thermal radiator using almost any colour temperature controllable lamp (perception of the light source such as an incandescent or halogen lamp). This parameter can be used to set the behaviour of the colour temperature during relative dimming of the brightness for the application mentioned.</p> <p>Change proportional to brightness: During relative dimming of the brightness with a 4-bit dimming telegram, the colour temperature of the group or single device is also changed proportionally. The colour temperature becomes warmer when dimming down. The colour temperature becomes colder when dimming up. The colour temperature can also be controlled separately.</p> <p>No change: The relative dimming of the brightness by a 4-bit dimming telegram has no effect on the colour temperature of the group or single device. The colour temperature can be controlled only separately.</p>	

9.2.2 Objects for colour temperature

Function	Name	Type	DPT	Flag
Relative colour temperature - Setting	Group 1...32 / Single device 1...64	4-bit	3.007	C, -, W, -, U
4-bit object for relative dimming of the colour temperature.				
Function	Name	Type	DPT	Flag
Absolute colour temperature - Setting	Group 1...32 / Single device 1...64	2-byte	7.600	C, -, W, -, U
2-byte object for specifying an absolute colour temperature value within the limits of the minimum and maximum colour temperature.				
Function	Name	Type	DPT	Flag
Relative dimming (brightness value and colour temperature) - Setting	Group 1...32 / Single device 1...64	3-byte	250.600	C, -, W, -, U
3-byte object for the combined relative dimming of the brightness and colour temperature by means of separate dimming increments and dimming directions.				

Function	Name	Type	DPT	Flag
Absolute dimming (brightness value and colour temperature) - Setting	Group 1...32 / Single device 1...64	6-byte	249.600	C, -, W, -, U
<p>6-byte object for the combined absolute dimming of the brightness and colour temperature by means of separate dimming values and for the specification of a dimming time.</p> <p>When dimming by means of the 6-byte combination object, it is possible to specify an individual dimming time in the KNX telegram. If a valid time is specified there, the gateway executes the dimming time transmitted in the KNX telegram and not the one specified in the ETS. The colour temperature and brightness specified in the telegram value is then dimmed to within the transmitted dimming time (fading). If the time is defined as "invalid" in the telegram, the gateway always executes the dimming behaviour defined in the ETS parameters during absolute dimming.</p>				

9.2.3 Human Centric Lighting (HCL)

Introduction

Human Centric Lighting (HCL) implements colour temperature sequences for implementing different lighting scenes depending on the time of day and day of the week. For this purpose, up to four freely configurable HCL matrices are available, which show four applications for person-centred lighting scenes as examples in the default setting. Each matrix allows individual daytime colour temperature gradients to be set with or without brightness adjustment. The matrices can be activated and switched over individually during operation of the gateway.

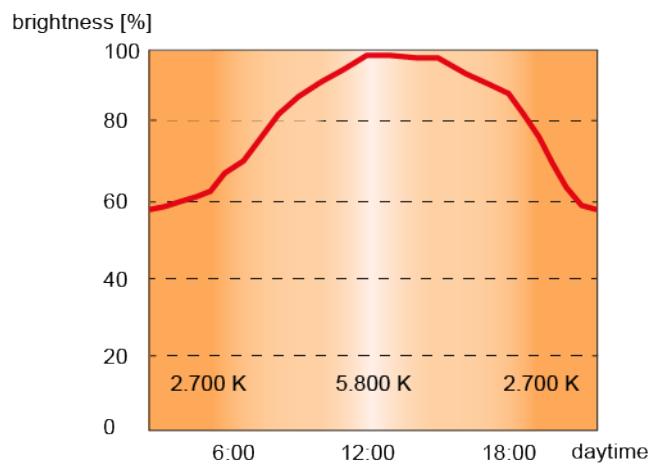

Figure 28: Exemplary daytime colour temperature sequence "Shop & Retail"

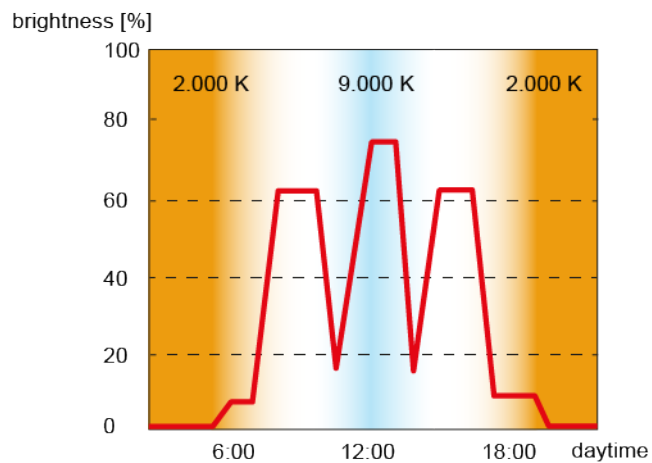

Figure 29: Exemplary daytime colour temperature sequence "Intensive learning"

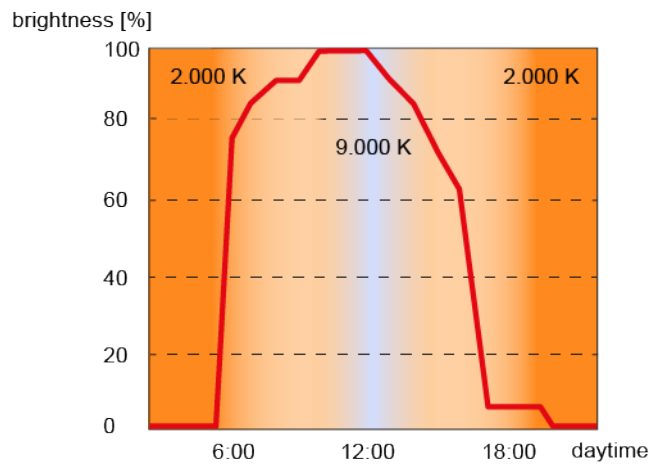

Figure 30: Exemplary daytime colour temperature sequence "Health & Care"

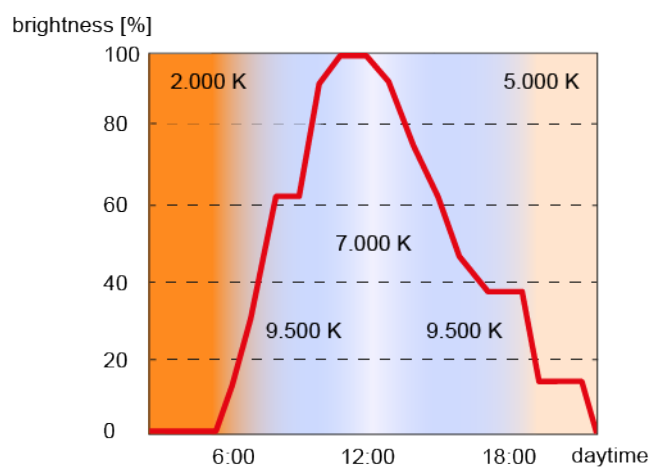

Figure 31: Exemplary daytime colour temperature sequence "Office work"

The colour temperature of an HCL matrix is always adjusted by means of the colour temperature value (K). As with dimming, the brightness is adjusted by means of the DALI ARC power level. Each HCL matrix contains the settings for the colour temperature (1,000...10,000 K) and brightness (0...100%) for each full hour of the day (0:00 midnight, 1:00 a.m., 2:00 a.m....11:00 p.m.). Depending on the time, the individual colour temperature and brightness values are called up in sequence. The values between two full hours are determined continuously every minute by linear interpolation in the process to implement a smooth colour temperature and brightness curve. Whether a daytime colour temperature sequence influences only the colour temperature or also the brightness during operation can be defined individually for each group and single device in the configuration.

Examples of linear interpolation of the colour temperature and brightness values
Time: 8:00 a.m., colour temperature: 2,000 K
Time: 9:00 a.m., colour temperature: 2,500 K
--> Time: 8:30 a.m., colour temperature: 2,250 K
Time: 10:00 a.m., brightness: 50%
Time: 11:00 a.m., brightness: 80%
--> Time: 10:30 a.m., brightness: 65%

- i** An active daytime colour temperature sequence influences the colour temperature and optionally also the brightness of a group or single device. The HCL function of the gateway triggers status telegrams for the colour temperature and brightness separately if there are changes to the values in the course of a start or running matrix. Here, the evaluation takes place every minute.

The HCL matrices are generally configured centrally for all groups and single devices of a DALI system. For the parameters of the groups and single devices, the individual assignment to up to four matrices takes place. During operation of the gateway, the matrix assignments of groups and single devices can be switched over by 1-byte objects. This allows individual switching of the pre-programmed daytime colour temperature sequences depending on the application.

The daytime colour temperature sequence of a group or single device can be started and stopped individually. A 1-bit communication object "Daytime colour temperature sequence (HCL) - Start/stop" is available for each group and single device for this purpose. When activated by an ON telegram, the execution of the daytime colour temperature sequence starts according to the current time and day of the week. When deactivated by an OFF telegram, the execution of the daytime colour temperature sequence is immediately terminated. The DALI operating devices then initially remain at the colour temperature and brightness value last set.

A daytime colour temperature sequence can be implemented with or alternatively without brightness adjustment. In an HCL matrix, the colour temperature and brightness values are always configured for each time. Whether a group or single device reacts only to the pre-programmed colour temperature or additionally to the defined brightness value is defined by the parameter "Type of daytime colour temperature sequence". If the daytime colour temperature sequence is run only with colour temperature adjustment, the gateway takes into account only the colour temperature value of the HCL matrix corresponding to the day of the week and the time of day. If a brightness adjustment is also to be made, the stored HCL brightness value is also executed.

A daytime colour temperature sequence is of the same priority as the normal control of the brightness and colour temperature of a group or a single device by the corresponding communication objects. A scene recall also is of the same priority. The functions mentioned above override a daytime colour temperature sequence in progress with regard to the colour temperature and brightness. In the event of overriding, a running daytime colour temperature sequence can be automatically stopped or alternatively continue to run in the background.

- i** A started daytime colour temperature sequence has no effect during an activated disabling or forced position. If the parameter for specifying the behaviour of the colour temperature or brightness at the end of a disabling function is configured to the "track" setting, the tracked colour temperature and optionally also the brightness of a daytime colour temperature sequence in progress is set at the end of disabling. If the tracking of the colour temperature or brightness is not configured at the end of disabling, no tracking of the values takes place. A daytime colour temperature sequence still in progress is then processed normally every minute depending on the time. The same applies in principle when revoking a forced position.

- i** During an active manual operation, a started daytime colour temperature sequence has no effect. The behaviour at the end of a manual operation is different for temporary and permanent manual operation modes. At the end of permanent manual operation, the configuration decides whether the colour temperature and optionally also the brightness of a daytime colour temperature sequence in progress is tracked or not. If tracking is not automatically performed, a daytime colour temperature sequence that continues to run is always processed normally every minute after temporary manual operation depending on the time. A daytime colour temperature sequence is always stopped after an ETS programming operation.
- i** No times or days of the week are updated if the gateway has not yet received any or a valid KNX telegram to set the internal clock after initialisation (after the mains voltage returns or an ETS programming operation). In this case, the daytime colour temperature sequence has no function!

Setting the designation of the HCL matrices

Up to four freely configurable HCL matrices are available for Human Centric Lighting (HCL). Each matrix can be given a designation, which is visible only in the ETS for better identification.

- On the parameter pages "DALI system... -> Colour temperature - HCL -> HCL matrix...", assign a "designation" to each matrix.

Setting the daytime colour temperature sequences in the HCL matrices

Each HCL matrix contains settings for the colour temperature (1,000...10,000 K) and brightness (0...100%) for each full hour of the daytime (0:00, 1:00 a.m., 2:00 a.m....11:00 p.m.) on the parameter pages "DALI system... -> Colour temperature - HCL -> HCL matrix...". Depending on the time of day, the individual colour temperature and brightness values are called up one after the other as the day colour temperature sequence progresses. The values between two full hours are determined continuously every minute by linear interpolation in the process to implement a smooth colour temperature and brightness curve.

- Depending on the time, configure the parameters for "colour temperature" and "brightness" to the desired values.
- i** In an HCL matrix, the colour temperature and brightness values are always configured for each time. Whether a group or single device reacts only to the pre-programmed colour temperature or additionally to the defined brightness value is defined by the "Type of daytime colour sequence" parameter on the parameter pages of the groups and single devices.
- i** The colour temperature values stored in an HCL matrix can always be configured within the range of 1,000...10,000 K and the brightness values within the range of 0...100%. If HCL values are outside the range defined by the minimum and maximum colour temperature or minimum and maximum brightness of assigned groups or single devices, the gateway limits the colour temperature and brightness to the defined limits when a daytime colour temperature sequence is running.

Setting the effective matrix after an ETS programming operation

The parameter "After ETS programming operation" on the parameter page "DALI system... -> Configuration groups -> [x] Group name -> Colour temperature -> HCL" or "DALI system... -> Configuration single devices -> [x] Device name -> Colour temperature -> HCL" defines which of the up to four HCL matrices is initially effective for the affected group or the single device after the gateway has been commissioned by the ETS or after a reset. Optionally, the matrix assignments can be switched by 1-byte objects during operation of the gateway.

- Set the parameter to the desired HCL matrix.
After an ETS programming operation or mains voltage return, the configured HCL matrix is effective. However, it is executed only when a start takes place.

Enabling switching of the effective matrix during operation

During operation of the gateway, the matrix assignments of groups and single devices can be switched over by 1-byte objects. This allows individual switching of the pre-programmed daytime colour temperature sequences depending on the application.

- Activate the "Switchable via object" parameter on the parameter page "DALI system... -> Configuration groups -> [x] Group name -> Colour temperature -> HCL" or "DALI system... -> Configuration single devices -> [x] Device name -> Colour temperature -> HCL".

The 1-byte communication object "Daytime colour temperature sequence (HCL) - Switch matrix" is available. According to KNX DPT 17.001, a switchover can be performed by the number of the matrix (1...4) during operation of the gateway.

- Deactivate the parameter "Switchable via object".
No communication object is available for switching over the HCL matrices during operation. The HCL matrix defined by the parameter "After ETS programming operation" always remains effective.

i Switching an HCL matrix is always possible during operation of the gateway. A switchover in the state "Daytime colour temperature sequence stopped" is saved by the gateway. At the next start, the gateway then executes the HCL matrix switched over last for the affected group or single device. In the case of a switchover in the state "Daytime colour temperature sequence started", the gateway executes the switched matrix every minute according to the time. The switched matrix therefore takes effect no later than one minute after the switchover.

i In principle, it is only possible to switch to the four HCL matrices configured in the ETS. There is no reaction if a matrix number (5...64) is received by means of the switch-over object not included in the configuration of the matrices.

i After an ETS programming operation or the mains voltage returns, the last switchover by means of the object is lost (object value "0"). A new telegram must first be received so that a new switchover becomes active.

Setting the type of daytime colour temperature sequence

A daytime colour temperature sequence can be implemented with or alternatively without brightness adjustment. Whether a group or single device reacts only to the pre-programmed colour temperature or additionally to the defined brightness value of the HCL matrix is determined by the parameter "Type of daytime colour temperature sequence" on the parameter page "DALI system... -> Configuration groups -> [x] Group name -> Colour temperature -> HCL" or "DALI system... -> Configuration single devices -> [x] Device name -> Colour temperature -> HCL".

- Set the parameter "Type of daytime colour temperature sequence" to "only colour temperature adjustment".
In this case, the gateway takes into account only the colour temperature value of the HCL matrix corresponding to the day of the week and the time of day. The brightness value stored in the matrix is ignored. The brightness can then be controlled by other functions of the gateway (e.g. by switching and dimming).
- Set the parameter "Type of daytime colour temperature sequence" to "Colour temperature and brightness adjustment".
In addition to evaluating the configured colour temperatures of the HCL matrices, the gateway also evaluates the stored brightness values.

Setting the behaviour in case of overriding

A daytime colour temperature sequence is of the same priority as the normal control of the brightness and colour temperature of a group or single device by the corresponding communication objects. A scene recall also is of the same priority. The functions mentioned above override a daytime colour temperature sequence in progress with regard to the colour temperature and brightness. In the event of overriding, a running daytime colour temperature sequence can be automatically stopped or alternatively continue to run in the background. The behaviour is defined by the parameter "Behaviour in case of overload" parameter on the parameter page "DALI system... -> Configuration groups -> [x] Group name -> Colour temperature -> HCL" or "DALI system... -> Configuration single devices -> [x] Device name -> Colour temperature -> HCL".

- Set the parameter "Behaviour in case of overload" to "HCL continues to work".
A running daytime colour temperature sequence can be overridden at any time by other functions of the gateway. However, the daytime colour temperature sequence continues to run, whereby the values stored in the HCL matrix continue to be called up continuously every minute, depending on the time. In this case, the commands received last or given for the colour temperature or brightness of other functions (e.g. scene recall) are replaced by the HCL values again at the latest after one minute.

With daytime colour temperature sequences with brightness adjustment, the brightness values defined in the HCL matrix are tracked. The gateway then continues to process the interpolated brightness values every minute and, if necessary, switches on any operating devices that have been switched off.

In the event of daytime colour temperature sequences without brightness adjustment, the colour temperature is internally tracked by the HCL matrix even if groups or single devices are switched off internally. If a group or single device is switched on, the gateway sets the tracked colour temperature so that DALI operating devices subsequently switched on indicate the correct values of the daytime colour temperature sequence.

- Set the parameter "Behaviour in case of overload" to "HCL is terminated".
If a daytime colour temperature sequence is automatically stopped by an override, the gateway immediately stops processing the assigned HCL matrix.

Defining effective weekdays

Human Centric Lighting (HCL) implements colour temperature sequences for implementing different lighting scenes depending on the time of day and day of the week. Depending on the time, the individual colour temperature and brightness values are called up in sequence. However, this is done only on selected weekdays. In the ETS configuration, it can be defined on which days of a week a day colour temperature sequence is executed.

- Set the selection of the effective weekdays on the parameter page "DALI system... -> Configuration groups -> [x] Group name -> Colour temperature -> HCL" or "DALI system... -> Configuration single devices -> [x] Device name -> Colour temperature -> HCL".

A started daytime colour temperature sequence is executed only on the configured weekdays. On days of a week not included in the selection, the colour temperature sequence is paused.

- i** If the KNX telegram for setting the internal clock contains the information "all days", the gateway no longer evaluates a discrete weekday and executes the day colour temperature sequence cyclically every day only according to the stored times.

9.2.3.1 Parameters for Human Centric Lighting (HCL)

DALI system... -> Colour temperature - HCL -> HCL matrix ...

Name	Shop & Retail Intensive learning Health & Care Office work
Each matrix can be given a designation, which is visible only in the ETS for better identification.	

Brightness	0...100%
Colour temperature	1,000...10,000 K
<p>Each HCL matrix contains the settings for the colour temperature (1,000...10,000 K) and brightness (0...100%) for each full hour of the day (0:00 midnight, 1:00 a.m., 2:00 a.m....11:00 p.m.). Depending on the time of day, the individual colour temperature and brightness values are called up one after the other as the day colour temperature sequence progresses. The values between two full hours are determined continuously every minute by linear interpolation in the process to implement a smooth colour temperature and brightness curve.</p> <p>In an HCL matrix, the colour temperature and brightness values are always configured for each time. Whether a group or single device reacts only to the pre-programmed colour temperature or additionally to the defined brightness value is defined by the parameter "Type of daytime colour temperature sequence" on the parameter pages of the groups and single devices.</p> <p>The colour temperature values stored in an HCL matrix can always be configured within the range of 1,000...10,000 K and the brightness values within the range of 0...100%. If HCL values are outside the range defined by the minimum and maximum colour temperature or minimum and maximum brightness of assigned groups or single devices, the gateway limits the colour temperature and brightness to the defined limits when a daytime colour temperature sequence is running.</p> <p>The "brightness" and "colour temperature" parameters are available for each full hour of an HCL matrix. The default setting of the parameters depends on the time.</p>	

DALI system... -> Configuration groups -> [x] Group name -> Colour temperature -> HCL

DALI system... -> Configuration single devices -> [x] Device name -> Colour temperature -> HCL

after ETS programming operation	HCL-matrix 1 HCL-matrix 2 HCL-matrix 3 HCL-matrix 4
<p>This parameter defines which of the up to four HCL matrices is initially effective for the affected group or single device after the gateway has been commissioned by the ETS or after a reset. Optionally, the matrix assignments can be switched by 1-byte objects during operation of the gateway.</p> <p>After an ETS programming operation or mains voltage return, the configured HCL matrix is effective. However, it is executed only when a start takes place.</p>	

Switchable via object	Checkbox (yes/no)
<p>During operation of the gateway, the matrix assignments of groups and single devices can be switched over by 1-byte objects. This allows individual switching of the pre-programmed daytime colour temperature sequences depending on the application.</p> <p>Checkbox activated: The 1-byte communication object "Daytime colour temperature sequence (HCL) - Switch matrix" is available. According to KNX DPT 17.001, a switchover can be performed by the number of the matrix (1...4) during operation of the gateway.</p> <p>Checkbox deactivated: No communication object is available for switching the HCL matrices during operation. The HCL matrix defined by the parameter "After ETS programming operation" always remains effective.</p>	
Type of daytime colour temperature sequence	only colour temperature adjustment Colour temperature and brightness adjustment
<p>A daytime colour temperature sequence can be implemented with or alternatively without brightness adjustment. Whether a group or single device reacts only to the pre-programmed colour temperature or additionally to the set brightness value of the HCL matrix is defined by this parameter.</p> <p>Only colour temperature adjustment: In this case, the gateway only takes into account the colour temperature value of the HCL matrix corresponding to the day of the week and the time of day. The brightness value stored in the matrix is ignored. The brightness can then be controlled by other functions of the gateway (e.g. by switching and dimming).</p> <p>Colour temperature and brightness adjustment: In addition to evaluating the configured colours of the HCL matrices, the gateway also evaluates the stored brightness values.</p>	

Behaviour in case of overload	<p>HCL continues to work HCL is terminated</p>
<p>A daytime colour temperature sequence is of the same priority as the normal control of the brightness and colour temperature of a group or single device by the corresponding communication objects. A scene recall also is of the same priority. The functions mentioned above override a daytime colour temperature sequence in progress with regard to the colour temperature and brightness.</p> <p>In the event of overriding, a running daytime colour temperature sequence can be automatically stopped or alternatively continue to run in the background. The behaviour is defined by this parameter.</p> <p>HCL continues to operate: A running daytime colour temperature sequence can be overridden at any time by other functions of the gateway. However, the daytime colour temperature sequence continues to run, whereby the values stored in the HCL matrix continue to be called up continuously every minute, depending on the time. In this case, the commands received last or given for the colour temperature or brightness of other functions (e.g. scene recall) are replaced by the HCL values again at the latest after one minute. With daytime colour temperature sequences with brightness adjustment, the brightness values defined in the HCL matrix are tracked. The gateway then continues to process the interpolated brightness values every minute and, if necessary, switches on any operating devices that have been switched off. In the event of daytime colour temperature sequences without brightness adjustment, the colour temperature is internally tracked by the HCL matrix even if groups or single devices are switched off internally. If a group or single device is switched on, the gateway sets the tracked colour temperature so that DALI operating devices subsequently switched on indicate the correct values of the daytime colour temperature sequence.</p> <p>HCL is terminated: If a daytime colour temperature sequence is automatically stopped by override, the gateway immediately stops processing the assigned HCL matrix.</p>	
Selection of effective weekdays	<p>Checkboxes (Mon, Tue, Wed, Thu, Fri, Sat, Sun)</p>
<p>Human Centric Lighting (HCL) implements colour temperature sequences for implementing different lighting scenes depending on the time of day and day of the week. Depending on the time, the individual colour temperature and brightness values are called up in sequence. However, this is done only on selected weekdays. In the ETS configuration, it can be defined at this point on which days of a week a daily colour temperature sequence is executed.</p> <p>A started daytime colour temperature sequence is executed only on the configured weekdays. On days of a week not included in the selection, the daytime colour temperature sequence is paused.</p>	

9.2.3.2 Objects for Human Centric Lighting (HCL)

Function	Name	Type	DPT	Flag
Daytime colour temperature sequence (HCL) - Start/stop	Group 1...32 / Single device 1...64	1-bit	1.003	C, -, W, -, U
<p>1-bit object for starting and stopping a daytime colour temperature sequence ("1" = start, "0" = stop).</p> <p>After the start, the execution of the daytime colour temperature sequence starts according to the current time and day of the week. When a stop is made, the execution of the daytime colour temperature sequence is immediately terminated.</p>				

Function	Name	Type	DPT	Flag
Daytime colour temperature sequence (HCL) - Switch matrix	Group 1...32 / Single device 1...64	1-byte	17.001	C, -, W, -, U
<p>1-byte object for switching the effective HCL matrix (1...4) during operation of the gateway.</p> <p>In principle, it is only possible to switch to the four HCL matrices configured in the ETS. There is no reaction if a matrix number (5...64) is received by means of the switch-over object not included in the configuration of the matrices.</p> <p>After an ETS programming operation or the mains voltage returns, the last switchover by means of the object is lost (object value "0"). A new telegram must first be received so that a new switchover becomes active.</p>				

9.3 Colour control

Specifying the colour space

The gateway can be used to control the light colour when using DALI operating devices of device type "DT8 - Colour Control". The gateway enables flexible colour control in the colour spaces "RGB", "RGBW", "HSV" or "HSVW". In the RGB colour spaces, the colours "red", "green", "blue" and optionally also "white" can be directly controlled by combined or separate communication objects according to the KNX specification. In the HSV colour spaces, separate objects are always available for controlling the light colour by absolute values for hue (H), saturation (S) and brightness value (V) and optionally also for the white value (W).

- i** DALI operating devices of the "DT8 - Colour Control" device type must at least correspond to the "Colour Control RGB" colour type. The colour type "white" [W] is additionally required in the colour space "RGBW" or "HSVW". The extended DALI colour types "AF" (Amber [A], Freecolour [F]) can be assigned to a group or single device in the course of DALI commissioning, but are not supported by the gateway.

The colour space to be used for group or single device control is defined by the parameter of the same name on the parameter pages "DALI system... -> Configuration groups -> [x] Group name -> Colour" or "DALI system... -> Configuration single devices -> [x] Device name -> Colour". Whether the colour space is available with or without the white value "W" is set in the general configuration of the groups and single devices under "DALI system... -> Configuration groups" or "DALI system... -> Configuration Single Devices".

- Set the parameter to "RGB combined" or "RGBW combined".

The colours "red", "green", "blue" and optionally also "white" are individually controlled by absolute values or a common object. This object has a size of 3 bytes in the colour space "RGB" (DPT 232.600) and 6 bytes in the colour space "RGBW" (DPT 251.600). The default colours transmitted by the 6-byte value are evaluated only if the corresponding 1-bit enable flags (bits 0...3) are "1" in the data value. With "0", the respective colour is ignored.

In addition to the default object, another object of the same data type is available for the status indication of the currently set colour.

The gateway transmits the RGBW colours received from the KNX directly to the DALI side. The parameter "On receipt of a colour value" defines whether the value is jumped to directly or alternatively a dimming process is carried out by means of time-controlled fading.

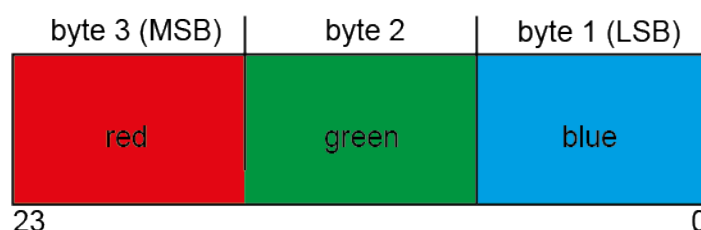

Figure 32: KNX data type "RGB combined" (DPT 232.600)

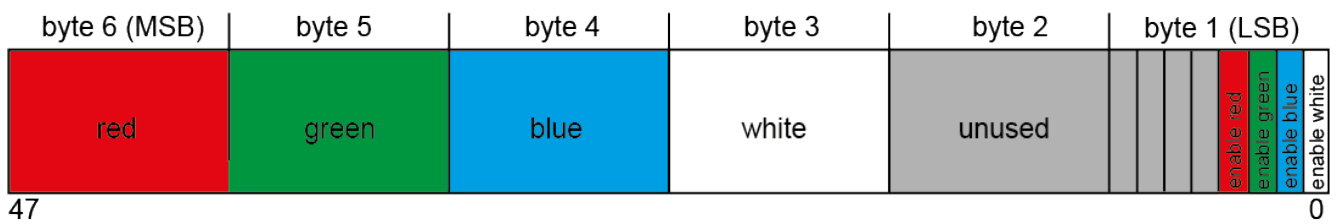

Figure 33: KNX data type "RGBW combined" (DPT 251.600)

- Set the parameter to "RGB individually" or "RGBW individually".
 The colours "red", "green", "blue" and optionally also "white" are individual controlled by separate objects. Switching (DPT 1.001 / ON & OFF), relative dimming (DPT 3.007 / dimming the colour intensity up and dim incl. stop) and the specification of an absolute value (DPT 5.001 / 0...100%) for each colour is possible. If required, a status object is available for each colour, which indicates the set absolute colour value (DPT 5.001 / 0...100%).

 When switching off a colour with the switching object, only the corresponding colour value is set to "#00" (dark colour). Other colour values remain unchanged. The switch-on behaviour is defined by the "Switch-on colour" parameter, whereby only the corresponding colour value in the parameter is evaluated. All other colour values remain unchanged. When a colour is switched on, the gateway always also switches on the brightness in the configured switch-on brightness.

 If all colours are dark (#000000 / black) and in this state at least one colour is selected by the object "Colour ... (Switching) - Setting" is switched on, the switch-on colour value is always activated. Fading then does not take place.

 The gateway transmits the RGBW colours received from the KNX directly to the DALI side. The parameter "On receipt of a colour value" defines whether the value is jumped to directly or alternatively a dimming process is carried out by means of time-controlled fading. When dimming a colour relatively, the gateway calculates the corresponding dimming curve using the parameter "Time between two dimming steps for relative dimming".
- Set the parameter to "HSV" or "HSVW".
 The colours "red", "green" and "blue" are individually controlled in the HSV colour space as an absolute value specification by separate 1-byte objects for the hue (H / DPT 5.003 / 0...360°), the saturation (S / DPT 5.001 / 0...100%) and the brightness value (V / DPT 5.001 / 0...100%). The white value is optionally specified by a separate 1-byte object (DPT 5.001 / 0...100%).

 The gateway calculates the RGB values used in the DALI from the specified HSV values. In addition to the default objects, four other objects of the same data types are available for the status indication of the colour currently set.

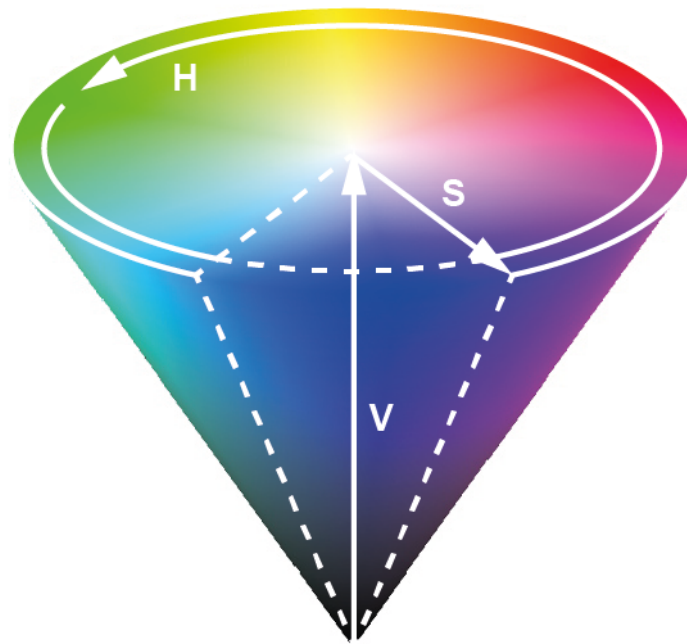

Figure 34: HSV colour space

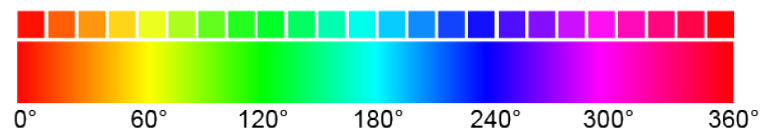

Figure 35: HSV colour (hue)

Setting the switch-on colour

The switch-on colour can be set separately for each DALI group and each single device.

- Set the "Switch-on colour" parameter in the parameter node "DALI system... -> Configuration groups -> [x] Group name -> Colour" or "DALI system... -> Configuration single devices -> [x] Device name -> Colour" to "preset". Set the desired colour in the parameters "Colour value (RGB)" and optionally "White value (W)".

The set colour is displayed on receipt of an ON telegram by the communication objects "Switching - Setting" or "Colour ... (Switching) - Setting" or after receiving a central telegram with the polarity "activated".

In the "RGB individually" or "RGBW individually" colour spaces, only the corresponding colour value (red, green or blue) is evaluated in the parameter when switching on with the objects "Colour ... (Switching)". All other colour values remain unchanged. When a colour is switched on, the gateway always also switches on the brightness in the configured switch-on brightness.

- Set the parameter "Switch-on colour" to "Memory value (value before last switch-off)".

When switching on, the colour that was active and stored internally before the last switch-off is set. This memory value is composed of the colour value and the optional white value and is stored in a non-volatile manner in the gateway so that the value is retained after a bus or mains voltage return. After an ETS programming operation, the memory colour value is predefined at "#FFFFFF" and the optional white value at "#FF".

- Set the parameter "Switch-on colour" to "track".

On switching on, the internally tracked colour temperature value most recently specified and in the "Brightness 0%" state is preset. The tracked colour is not influenced by an ETS programming operation or by a bus voltage failure ("no change"). When the bus/mains voltage returns, the colour most recently active before the bus/mains voltage failure is restored. Consequently, this colour is taken into account as a value to be tracked when switching on.

- i** A memory value is also then saved internally by a switch-off telegram if the bus-controlled switch-off is overridden, for example, by a disable or forced position function or by a manual operation. In this case, the internally tracked colour value is saved as memory value.
- i** The colour to be set by switching on is either dimmed in the configured dimming time or is jumped to directly depending on the configured dimming behaviour (absolute dimming). The dimming characteristic curve for colour changes is always linear.

Dimming characteristic and dimming speeds

When controlling groups or single devices, the colour can be influenced by an absolute dimming process (value specification). In the "RGB individually" or "RGBW individually" colour space, it is also possible to relatively dim a colour or the white value with a 4-bit telegram (DPT 3.007).

- Absolute dimming:
Absolute dimming is triggered by the specification of a colour or white value. Depending on the configured colour space, these values can be determined either by the RGB communication objects present in each single device "Colour ... (Value) - Setting" or alternatively by the HSV value objects "Hue (H)", "Saturation (S)" and "Brightness Value (V)". In addition, colour values can also be set by the scene function.
When specifying a colour value by the objects mentioned or by a scene recall, it can be parameterised whether the value is jumped to directly or alternatively dimmed by a dimming time (Fading Time).
An absolute dimming telegram for controlling the colour can also switch on a group or single device in the "OFF" state. Here too, it may be necessary in some applications for a switched off group or switched off device to still remain off if a new colour value is specified absolutely. The parameter "Behaviour in the switched-off state when changing the colour by absolute dimming" determines whether a DALI group or a single device in the "OFF" state is switched on by a new absolute colour dimming telegram or remains switched off.

- Relative dimming:
Relative dimming can be triggered by the existing 4-bit communication object "Colour ... (Dimming) - Setting" for each colour or optionally also triggered by the object "White (Dimming) - Setting". The data format of these objects - as well as with relative dimming of the brightness - complies with the KNX DPT 3.007, which means that the dimming direction and relative dimming increments can be predefined in the dimming telegram or dimming procedures can also be stopped. A relative dimming process allows the colour intensity to be changed continuously.
The dimming speed for relative dimming can be configured separately for each group and each single device and independent of the dimming speed for a brightness change.
Just as with absolute dimming, a relative colour dimming telegram can also switch on a group or single device in the "OFF" state. In some applications, it may be necessary, however, for a switched off group or switched off device to still remain off until a relative dimming telegram of the colour is received. This is interesting when using light scenes, for instance: Several DALI groups are set to a defined colour via a light scene. Other groups are switched off by the scene. Only the colour of channels not switched off by the scene recall should be changed by dimming up afterwards. Here, it is necessary for groups or single devices not to respond to a relative dimming telegram and thus not to switch on. The parameter "Behaviour in the switched-off state when changing the colour by relative dimming" determines whether a DALI group or single device in the "OFF" state is switched on by a relative dimming telegram of the colour, or remains switched off.
- i** The dimming characteristic curve for colour changes is always linear.
- i** A dimming process of the colour cannot be triggered with the manual control on site at the device.
- i** Even if colour values are instantly jumped to, the dimming procedure on DALI operating devices always takes a very short time. This dimming procedure is dependent on the system. The colour value jumped to will be dimmed to within 0.7 seconds (short fading). This time cannot be altered.

Setting dimming behaviour for absolute dimming

- Set the parameter "On receipt of a colour value" in the parameter node "DALI system... -> Configuration groups -> [x] Group name -> Colour" or "DALI system... -> Configuration single devices -> [x] Device name -> Colour" to "Fading...".
As soon as a new colour value is received, the gateway sets this value within the specified fading time.
- Set the parameter "On receipt of a colour value" to "jumping to".
As soon as a new colour value is received it will be instantly jumped to.
- i** During a scene recall, the dimming behaviour can be configured separately.

Setting dimming time for relative dimming

The dimming time for relative dimming can be set only in the colour space "RGB individually" and "RGBW individually".

The "Colour space" parameter must be set to "RGB individually" or "RGBW individually".

- Set the parameter "Time between two dimming steps for relative dimming" in the parameter node "DALI system... -> Configuration groups -> [x] Group name -> Colour" or "DALI system... -> Configuration single devices -> [x] Device name -> Colour" to the required dimming time.

Setting dimming behaviour in OFF state for absolute dimming

An absolute colour telegram can switch on a group or single device in the "OFF" state, whereby the behaviour is set by the parameter "Behaviour in the off state when changing the colour by absolute dimming".

- Set the parameter to "Switch-on".

The group or single device switches on in the configured switch-on brightness in the "OFF" state by an absolute colour telegram. The colour is set to the received colour value. If the colour dimming behaviour is configured to "jumping to", the intended colour value is set immediately. If the dimming behaviour is configured to "fading...", the dimming process starts at the colour value most recently set by the gateway or that was tracked in the "OFF" state. The dimming process is executed according to the set fading time. After reaching the intended colour, the dimming process stops.
-  Usually DALI operating devices initially switch on automatically with the last active colour value after being switched on. The operating devices then immediately dim to the absolutely specified colour (jumping to: by standard fading of 0.7 s / dimming: by configured fading).
- Set the parameter to "No reaction".

The group or the single device does not switch on in the "OFF" state by the absolute colour telegram. The group or single device remains switched off. The next time the device is switched on, the last colour value received is tracked only if the "Switch-on colour" parameter is set to "track".

Setting dimming behaviour in OFF state for relative dimming

A relative colour dimming telegram can also switch on a group or single device in the "RGB individually" and "RGBW individually" colour space in the "OFF" state, whereby the behaviour is set by the parameter "Behaviour in the off state when changing the colour by relative dimming". The colours "red", "green", "blue" and optionally also "white" are individually controlled by separate 4-bit objects.

- Set the parameter to "Switch-on".

The group or the single device switches on in the "OFF" state by a relative colour dimming telegram to the configured switch-on brightness. The colour is set to the configured switch-on colour. Based on this colour state, the colour to be

dimmed is dimmed. The relative dimming telegram that leads to switching on, specifies the dimming direction and dimming increment. After reaching the intended colour, the dimming process stops.

i Usually DALI operating devices initially switch on automatically with the last active colour value after being switched on. Afterwards, the operating devices immediately dim to the predefined switch-on colour (by standard fading of 0.7 s). Only then does the relative dimming process of the colour to be dimmed start. Switching from the last active colour to the switch-on colour can initially cause rapid colour changes, which not only changes the relative colour to be dimmed.

- Set the parameter to "No reaction".

The group or the single device in the "OFF" state is not switched on by the relative colour dimming telegram. The group or single device remains switched off. The next time the device is switched on, the last dimmed colour value is tracked only if the "Switch-on colour" parameter is set to "track".

9.3.1 Parameters for colour control

DALI system... -> Configuration groups -> [x] Group name -> Colour

DALI system... -> Configuration single devices -> [x] Device name -> Colour

Colour space	RGB combined RGBW combined RGB individually RGBW individually HSV HSVW
<p>The gateway can be used to control the light colour when using DALI operating devices of device type "DT8 - Colour Control". The gateway enables flexible colour control in the colour spaces "RGB", "RGBW", "HSV" or "HSVW". In the RGB colour spaces, the colours "red", "green", "blue" and optionally also "white" can be directly controlled by combined or separate communication objects according to the KNX specification. In the HSV colour spaces, separate objects are always available for controlling the light colour by absolute values for hue (H), saturation (S) and brightness value (V) and optionally also for the white value (W).</p> <p>Whether the colour space is available with or without the white value "W" is set in the general configuration of the groups and single devices under "DALI system... -> Configuration groups" or "DALI system... -> Configuration Single Devices".</p> <p>RGB combined: The colours "red", "green", "blue" and optionally also "white" are individually controlled by absolute values by means of a common object. This object is 3 bytes in size (DPT 232.600). In addition to the default object, another object of the same data type is available for the status indication of the currently set colour. The gateway transmits the RGBW colours received from the KNX directly to the DALI side.</p> <p>RGBW combined: The colours "red", "green", "blue" and optionally also "white" are individually controlled by absolute values by means of a common object. This object is 6 bytes in size (DPT 251.600). The transmitted default colours are evaluated only if the corresponding 1-bit enable flags (bits 0...3) are in the data value "1". With "0", the respective colour is ignored. In addition to the default object, another object of the same data type is available for the status indication of the currently set colour. The gateway transmits the RGBW colours received from the KNX directly to the DALI side.</p> <p>RGB individually: The colours "red", "green" and "blue" are individually controlled by separate objects. Switching (DPT 1.001 / ON & OFF), relative dimming (DPT 3.007 / dimming the colour intensity up and down incl. stop) and the specification of an absolute value (DPT 5.001 / 0...100%) are possible for each colour. If required, a status object is available for each colour, which indicates the absolute colour value set (DPT 5.001 / 0...100%). The gateway transmits the RGB colours received from the KNX directly to the DALI side.</p> <p>RGBW individually: The colours "red", "green" and "blue" and "white" are individually controlled by separate objects in each case. Switching (DPT 1.001 / ON & OFF), relative dimming (DPT 3.007 / dimming the colour intensity up and down incl. stop) and the specification of an absolute value (DPT 5.001 / 0...100%) are possible for each colour. If required, a status object is available for each colour that indicates the set absolute colour value (DPT 5.001 / 0...100%). The gateway transmits the RGBW colours received from the KNX directly to the DALI side.</p>	

Colour space (continued)	RGB combined RGBW combined RGB individually RGBW individually HSV HSVW
<p>HSV: The colours "red", "green" and "blue" are individually controlled in the HSV colour space as an absolute value specification by separate 1-byte objects for the hue (H / DPT 5.003 / 0...360°), saturation (S / DPT 5.001 / 0...100%) and brightness value (V / DPT 5.001 / 0...100%). The gateway calculates the RGB values used in the DALI from the specified HSV values. In addition to the default objects, four other objects of the same data types are available for the status indication of the colour currently set.</p> <p>HSVW: The colours "red", "green" and "blue" are individually controlled in the HSV colour space as an absolute value specification by separate 1-byte objects for the hue (H / DPT 5.003 / 0...360°), saturation (S / DPT 5.001 / 0...100%) and brightness value (V / DPT 5.001 / 0...100%). The white value is optionally specified by a separate 1-byte object (DPT 5.001 / 0...100%). The gateway calculates the RGB values used in the DALI from the specified HSV values. In addition to the default objects, four other objects of the same data types are available for the status indication of the colour currently set.</p>	

Switch-on colour	track preset memory value (value bef. switching-off last time)
<p>At this point, the colour can be specified, which is set every time the DALI operating devices are switched on. This parameter defines the switch-on colour value separately for each group and each single device.</p> <p>Track: When switching on, the colour value specified last and internally tracked in the "Brightness 0%" state is set. The tracked colour is not influenced by an ETS programming operation or by a bus voltage failure ("no change"). When the bus/mains voltage returns, the colour most recently active before the bus/mains voltage failure is restored. Consequently, this colour is taken into account as a value to be tracked when switching on.</p> <p>Preset: The set colour is set with polarity "activated" when an ON telegram is received by means of the communication objects "Switch - Setting" or "Colour ... (Switching) - Setting" or when receiving a central telegram with the polarity "activated". In the "RGB individually" or "RGBW individually" colour spaces, only the corresponding colour value (red, green or blue) is evaluated in the parameter when switching on with the objects "Colour ... (Switching)". All other colour values remain unchanged. When a colour is switched on, the gateway always also switches on the brightness in the configured switch-on brightness.</p> <p>Memory value (value before the last switch-off): When switching on, the colour is set that was active and stored internally before the last switch-off. This memory value is composed of the colour value and the optional white value and is stored in a non-volatile manner in the gateway so that the value is retained after a bus or mains voltage return. After an ETS programming operation, the memory colour value is predefined at "#FFFFFF" and the optional white value at "#FF".</p>	
Colour value (RGB)	#000000...#FFFFFF
<p>Setting the switch-on colour value by means of the ETS colour picker. In the HSV colour space, the HSV values are calculated from the RGB values by means of the colour picker.</p> <p>This parameter is only available in the setting "Switch-on colour = preset".</p>	
White value (W)	0...255
<p>Setting of the white value of the switch-on colour.</p> <p>This parameter is available only in the setting "Switch-on colour = preset" in the colour spaces "RGBW combined", "RGBW individually" and "HSVW".</p>	

On receipt of a colour value	jumping to Fading (0.7 s) Fading (1.4 s) Fading (2.0 s) Fading (2.8 s) Fading (4.0 s) Fading (5.7 s) Fading (8.0 s) Fading (11.3 s) Fading (16.0 s) Fading (22.5 s) Fading (32.0 s) Fading (45.3 s) Fading (64.0 s) Fading (90.5 s)
<p>This parameter defines the dimming behaviour for absolute dimming by means of the object "Colour ... (value) - Setting" for a group or single device.</p> <p>jumping to: As soon as a new colour value is received it will be instantly jumped to. Even if colour values are instantly jumped to, the dimming procedure on DALI operating devices always takes a very short time. This dimming procedure is dependent on the system. The colour value jumped to will be dimmed to within 0.7 seconds (short fading). This time cannot be altered.</p> <p>Fading: As soon as a new colour value is received, the gateway sets this value within the specified fading time.</p>	
Time between two dimming steps for relative dimming	1... 25 ...255 ms
<p>Relative dimming can be triggered by the existing 4-bit communication object "Colour ... (Dimming) - Setting" for each colour or optionally also triggered by the object "White (Dimming) - Setting". The data format of these objects - as well as with relative dimming of the brightness - complies with the KNX DPT 3.007, which means that the dimming direction and relative dimming increments can be predefined in the dimming telegram or dimming procedures can also be stopped. A relative dimming process allows the colour intensity to be changed continuously.</p> <p>The dimming speed for relative dimming of the colour can be configured at this point. This parameter is available only in the colour spaces "RGB individually" and "RGBW individually".</p>	

Behaviour when switched-off when changing the colour by absolute dimming	switch-on no reaction
<p>An absolute colour telegram can also switch on a group or single device in the "OFF" state, with the behaviour set by this parameter.</p> <p>Switch-on: The group or the single device switches on in the "OFF" state by an absolute colour telegram in the configured switch-on brightness. The colour is set to the received colour value. If the colour dimming behaviour is configured to "jumping to", the intended colour value is set immediately. If the dimming behaviour is configured to "fading...", the dimming process starts at the colour value most recently set by the gateway or that was tracked in the "OFF" state. The dimming process is executed according to the set fading time. After reaching the intended colour, the dimming process stops.</p> <p>No reaction: The group or the single device does not switch on in the "OFF" state by the absolute colour telegram. The group or single device remains switched off. The next time the device is switched on, the last colour value received is tracked only if the "Switch-on colour" parameter is set to "track".</p>	

Behaviour when switched-off when changing the colour by relative dimming	switch-on no reaction
<p>A relative colour dimming telegram can also switch on a group or single device in the "RGB individually" and "RGBW individually" colour space in the "OFF" state, with the behaviour set by this parameter. The colours "red", "green", "blue" and optionally also "white" are individually controlled by separate 4-bit objects.</p> <p>Switch-on: The group or single device switches on in the configured switch-on brightness in the "OFF" state by a relative colour dimming telegram. The colour is set to the configured switch-on colour. Based on this colour state, the colour to be dimmed is dimmed. The relative dimming telegram that leads to switching on, specifies the dimming direction and dimming increment. After reaching the intended colour, the dimming process stops.</p> <p>No reaction: The group or the single device in the "OFF" state is not switched on by the relative colour dimming telegram. The group or single device remains switched off. The next time the device is switched on, the last dimmed colour value is tracked only if the "Switch-on colour" parameter is set to "track".</p>	

9.3.2 Colour control objects

Objects for controlling the colour space

Function	Name	Type	DPT	Flag									
Colour RGB (value) - Setting	Group 1...32 / Single device 1...64	3-byte	232.600	C, -, W, -, U									
3-byte object for combined absolute specification of an RGB light colour.													
<table border="1" style="width: 100%; text-align: center;"> <tr> <td style="width: 33%;">byte 3 (MSB)</td> <td style="width: 33%;">byte 2</td> <td style="width: 33%;">byte 1 (LSB)</td> </tr> <tr> <td style="background-color: red; color: white;">red</td> <td style="background-color: green; color: white;">green</td> <td style="background-color: blue; color: white;">blue</td> </tr> <tr> <td>23</td> <td></td> <td>0</td> </tr> </table>					byte 3 (MSB)	byte 2	byte 1 (LSB)	red	green	blue	23		0
byte 3 (MSB)	byte 2	byte 1 (LSB)											
red	green	blue											
23		0											
This object is available only in the "RGB combined" colour space.													

Function	Name	Type	DPT	Flag																		
Colour RGBW (value) - Setting	Group 1...32 / Single device 1...64	6-byte	251.600	C, -, W, -, U																		
6-byte object for combined absolute specification of an RGB light colour.																						
<table border="1" style="width: 100%; text-align: center;"> <tr> <td style="width: 16.6%;">byte 6 (MSB)</td> <td style="width: 16.6%;">byte 5</td> <td style="width: 16.6%;">byte 4</td> <td style="width: 16.6%;">byte 3</td> <td style="width: 16.6%;">byte 2</td> <td style="width: 16.6%;">byte 1 (LSB)</td> </tr> <tr> <td style="background-color: red; color: white;">red</td> <td style="background-color: green; color: white;">green</td> <td style="background-color: blue; color: white;">blue</td> <td style="background-color: white; color: black;">white</td> <td style="background-color: gray; color: black;">unused</td> <td style="background-color: gray; color: black;">enable red enable green enable blue enable white</td> </tr> <tr> <td>47</td> <td></td> <td></td> <td></td> <td></td> <td>0</td> </tr> </table>					byte 6 (MSB)	byte 5	byte 4	byte 3	byte 2	byte 1 (LSB)	red	green	blue	white	unused	enable red enable green enable blue enable white	47					0
byte 6 (MSB)	byte 5	byte 4	byte 3	byte 2	byte 1 (LSB)																	
red	green	blue	white	unused	enable red enable green enable blue enable white																	
47					0																	
This object is available only in the "RGBW combined" colour space.																						

Function	Name	Type	DPT	Flag
Colour red (switching) - Setting	Group 1...32 / Single device 1...64	1-bit	1.001	C, -, W, -, U
1-bit object for switching the light colour red. When switching off the colour with the switching object, only the colour value for red is set to "#00" (black). Other colour values remain unchanged. The switch-on behaviour is defined by the "Switch-on colour" parameter, whereby only the colour value for red is evaluated in the parameter. All other colour values remain unchanged. When a colour is switched on, the gateway always also switches on the brightness in the configured switch-on brightness. This object is available only in the "RGB individually" or "RGBW individually" colour space.				

Function	Name	Type	DPT	Flag
Colour green (switching) - Setting	Group 1...32 / Single device 1...64	1-bit	1.001	C, -, W, -, U
<p>1-bit object for switching the light colour green. When switching off the colour with the switching object, only the colour value for green is set to "#00" (black). Other colour values remain unchanged. The switch-on behaviour is defined by the "Switch-on colour" parameter, whereby only the colour value for green is evaluated in the parameter. All other colour values remain unchanged. When a colour is switched on, the gateway always also switches on the brightness in the configured switch-on brightness.</p> <p>This object is available only in the "RGB individually" or "RGBW individually" colour space.</p>				
Function	Name	Type	DPT	Flag
Colour blue (switching) - Setting	Group 1...32 / Single device 1...64	1-bit	1.001	C, -, W, -, U
<p>1-bit object for switching the light colour blue. When switching off the colour with the switching object, only the colour value for blue is set to "#00" (black). Other colour values remain unchanged. The switch-on behaviour is defined by the "Switch-on colour" parameter, whereby only the colour value for blue is evaluated in the parameter. All other colour values remain unchanged. When a colour is switched on, the gateway always also switches on the brightness in the configured switch-on brightness.</p> <p>This object is available only in the "RGB individually" or "RGBW individually" colour space.</p>				
Function	Name	Type	DPT	Flag
Colour white (switching) - Setting	Group 1...32 / Single device 1...64	1-bit	1.001	C, -, W, -, U
<p>1-bit object for switching the light colour white. When switching off the colour with the switching object, only the colour value for white is set to "#00" (black). Other colour values remain unchanged. The switch-on behaviour is defined by the "Switch-on colour" parameter, whereby only the colour value for white is evaluated in the parameter. All other colour values remain unchanged. When a colour is switched on, the gateway always also switches on the brightness in the configured switch-on brightness.</p> <p>This object is available only in the "RGBW individually" colour space.</p>				
Function	Name	Type	DPT	Flag
Colour red (value) - Setting	Group 1...32 / Single device 1...64	1-byte	5.001	C, -, W, -, U
<p>1-byte object for absolute specification of the light colour red (0...100%).</p> <p>This object is available only in the "RGB individually" or "RGBW individually" colour space.</p>				

Function	Name	Type	DPT	Flag
Colour Green (Value) - Setting	Group 1...32 / Single device 1...64	1-byte	5.001	C, -, W, -, U
1-byte object for absolute specification of the light colour green (0...100%). This object is available only in the "RGB individually" or "RGBW individually" colour space.				

Function	Name	Type	DPT	Flag
Colour Blue (value) - Setting	Group 1...32 / Single device 1...64	1-byte	5.001	C, -, W, -, U
1-byte object for absolute presetting of the light colour blue (0...100%). This object is available only in the "RGB individually" or "RGBW individually" colour space.				

Function	Name	Type	DPT	Flag
Colour white (value) - Setting	Group 1...32 / Single device 1...64	1-byte	5.001	C, -, W, -, U
1-byte object for absolute specification of the light colour white (0...100%). This object is available only in the "RGBW individually" colour space.				

Function	Name	Type	DPT	Flag
Colour red (dimming) - Setting	Group 1...32 / Single device 1...64	4-bit	3.007	C, -, W, -, U
4-bit object for relative specification of the light colour red (0...100%). This object is available only in the "RGB individually" or "RGBW individually" colour space.				

Function	Name	Type	DPT	Flag
Colour green (dimming) - Setting	Group 1...32 / Single device 1...64	4-bit	3.007	C, -, W, -, U
4-bit object for relative specification of the light colour green (0...100%). This object is available only in the "RGB individually" or "RGBW individually" colour space.				

Function	Name	Type	DPT	Flag
Colour blue (dimming) - Setting	Group 1...32 / Single device 1...64	4-bit	3.007	C, -, W, -, U
4-bit object for relative specification of the light colour blue (0...100%). This object is available only in the "RGB individually" or "RGBW individually" colour space.				

Function	Name	Type	DPT	Flag
Colour white (dimming) - Setting	Group 1...32 / Single device 1...64	4-bit	3.007	C, -, W, -, U
4-bit object for relative specification of the light colour white (0...100%). This object is available only in the "RGBW individually" colour space.				
Function	Name	Type	DPT	Flag
Colour hue (H) - Setting	Group 1...32 / Single device 1...64	1-byte	5.003	C, -, W, -, U
1-byte object for direct specification of the hue (H / 0...360°). This object is available only in the "HSV" or "HSVW" colour space.				
Function	Name	Type	DPT	Flag
Saturation (S) - Setting	Group 1...32 / Single device 1...64	1-byte	5.001	C, -, W, -, U
1-byte object for direct specification of the saturation (S / 0...100%). This object is available only in the "HSV" or "HSVW" colour space.				
Function	Name	Type	DPT	Flag
Brightness (V) - Setting	Group 1...32 / Single device 1...64	1-byte	5.001	C, -, W, -, U
1-byte object for direct specification of the brightness value (V / 0...100%). This object is available only in the "HSV" or "HSVW" colour space.				
Function	Name	Type	DPT	Flag
White value (W) - Setting	Group 1...32 / Single device 1...64	1-byte	5.001	C, -, W, -, U
1-byte object for direct specification of the white value (W / 0...100%). This object is available only in the "HSVW" colour space.				

9.3.3 Automatic colour wheel sequence

Introduction

The colour wheel sequence is used for the automatic overall colour control of DALI lights. This function uses the cyclical adjustment of the hue angle in the HSV colour wheel. This results in continuous colour gradients that can be started and stopped at will during the running time of the gateway.

After starting, the automatically controlled step-by-step sequence of the colour wheel begins. With each step, the current hue is either increased or decreased depending on the configured "sequence direction", converted into an RGB value and transmitted on the DALI line. The number of steps and consequently the increment of the hue is derived from the configured "total running time". The longer the total running time is considered in a full colour wheel sequence, the finer is the hue adjustment during the sequence and thus the colour resolution.

The adjustment of the hue always starts with the colour currently set when groups or single devices are switched on. For switched-off groups or single devices, the start-up behaviour is determined by the parameter "When starting in switched-off state". Here it is possible that the start does not switch on the affected group or single device and the gateway executes the colour sequence only internally. Only a subsequent switch-on then switches the lamps to the internally tracked colour. Alternatively, starting a colour wheel sequence can immediately switch on a group or single device in the OFF state. In this case, the colour wheel sequence starts at an individual start value. This start value can either be specified as a fixed initial hue (optionally with static white value) in the ETS, or alternatively it can be set to the colour at which a stop was last executed in the course of a previous colour wheel sequence.

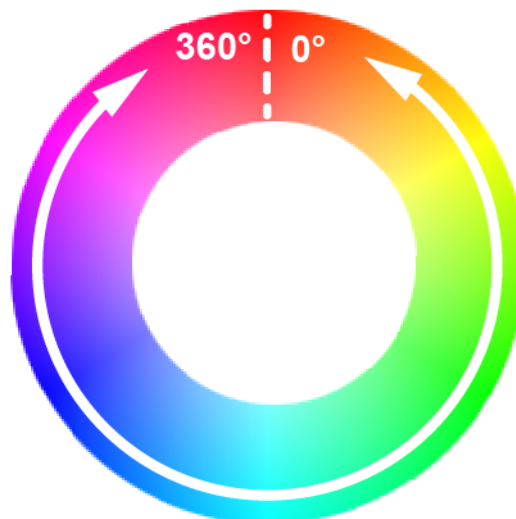

Figure 36: Colour run depending on the colour hue during the automatic colour wheel sequence

The sequence direction may be either clockwise, anti-clockwise or alternating (toggling). When switching over, the gateway automatically changes the direction of the colour wheel sequence after each start. The hue adjustment range is limited to 0° to 360° according to the HSV colour space. It can be defined in the ETS whether the

colour wheel sequence is stopped or continued in the same direction without interruption after reaching the range limit 360° or 0°. Optionally, a short visualisation can be carried out by the lamp when the range limit is reached in order to continue the sequence afterwards. This visual feedback is provided by briefly switching the assigned DALI operating devices off and on again. The time between OFF and ON is invariably 1 second.

A colour wheel sequence always stops as soon as a stop command is received with the KNX communication object "Automatic colour wheel sequence - Start/stop". The colour last set by the colour wheel sequence is initially retained until it is changed by a new colour wheel sequence or by other functions of the gateway. A sequence is started and stopped by an object whose data format can be configured either to 1-bit (DPT 1.010 / "1" = start, "0" = stop) or alternatively to 4-bit (DPT 3.007 / "Dimming step up or down" = start, "Dimming stop" = stop).

- i** The colour wheel is always run through according to the hue of the HSV colour space, regardless of which colour space is configured for the group or single device. The colour specified by the hue is automatically converted by the gateway into an equivalent RGB value and forwarded to the DALI operating devices.
- i** The additionally definable white value in the "RGBW..." or "HSVW..." colour spaces is always static in the automatic colour wheel sequence. The white value is not changed dynamically.
- i** During a colour wheel sequence, the values for colour saturation and brightness remain constant at the maximum value (100%). Only the hue is adjusted.

Setting the start/stop behaviour of the colour wheel sequence

The parameter "Start and stop by" on the parameter page "DALI system... -> Configuration groups -> [x] Group name -> Colour -> Colour wheel sequence" or "DALI system... -> Configuration single devices -> [x] Device name -> Colour -> Colour wheel sequence" specifies the data format of the communication object for starting and stopping the automatic colour wheel sequence.

- Set the parameter to "Start/Stop object (1 bit)".
A sequence is started and stopped by the object "Automatic colour wheel sequence - Start/Stop". The data format is set to 1-bit (DPT 1.010). A sequence is started by an ON telegram. A sequence is stopped by an OFF telegram.
- Set the parameter to "Dimming object (4-bit)".
A sequence is started and stopped by the object "Automatic colour wheel sequence - Start/Stop". The data format is set to 4-bit (DPT 3.007). A sequence is started by a "Dimming step up or down" telegram. A sequence is stopped by a "Dimming stop" telegram.
- i** Changes in brightness do not stop a colour wheel sequence in progress if this does not change the switching status. The colour wheel sequence is stopped when the affected group or single device is switched off (brightness 0%).

- i** The colour wheel sequence and brightness sequence cannot run at the same time. As soon as the colour wheel sequence has been started, the brightness sequence is automatically stopped. The same applies vice versa. It is not permissible to link the start/stop objects of both functions of a group or single device with identical group addresses!
- i** During an activated lock or forced position, any colour wheel sequence that has been started has no effect. If the parameter for the specification of the behaviour of the colour at the end of the disabling function is configured to the setting "track", the tracked colour of a running colour wheel sequence is set at the end of the lock, provided the group or single device concerned is switched on. If no colour tracking is configured at the end of disabling, the automatic colour wheel sequence is stopped.
- i** During an active manual operation, any colour wheel sequence that has been started has no effect. At the end of a manual operation, the tracked colour of a current colour wheel sequence is set. A valid scene recall stops the automatic colour wheel sequence. After an ETS programming operation, a colour wheel sequence is always stopped.
- i** No colour status telegrams are generated during a colour wheel sequence (not even during a continuous sequence after reaching the range limits and direction reversal). Only when a sequence is stopped does the gateway send out the current colour as a status.
- i** If several colour wheel sequences run simultaneously in different groups or single devices, this can cause an overload of the DALI system, whereby calculated hues cannot always be safely transmitted to the operating devices.

Setting the starting behaviour of the colour wheel sequence in switched-off state

The adjustment of the hue always starts with the colour currently set when groups or single devices are switched on. When groups or single devices are switched off, the start-up behaviour is determined by the parameter "When starting in switched-off state" on the parameter page "DALI system... -> Configuration groups -> [x] Group name -> Colour -> Colour wheel sequence" or "DALI system... -> Configuration single devices -> [x] Device name -> Colour -> Colour wheel sequence".

- Set the parameter to "No reaction".
When starting, the affected group or single device is not switched on. The gateway executes the colour sequence only internally. Only when the brightness is subsequently switched on does the lamp change to the internally tracked colour, but only if the switch-on colour is also configured to "track".
- Set the parameter to "Switch-on".
Starting a colour wheel sequence immediately switches on a group or single device. In this case, the colour wheel sequence starts at the start value configured by the parameter of the same name.
- Set the "Start value" parameter to "preset".

A fixed start value is specified as the start hue (optionally with static white value).

- Set the "Start value" parameter to "value as before last stop".
The colour wheel sequence starts at the colour that was stopped last during the previous colour wheel sequence.

Setting the direction of the colour wheel sequence

The "Sequence direction" parameter on the parameter page "DALI system... -> Configuration groups -> [x] Group name -> Colour -> Colour wheel sequence" or "DALI system... -> Configuration single devices -> [x] Device name -> Colour -> Colour wheel sequence" defines the sequence direction of an automatic colour wheel sequence after starting.

- Set the parameter to "clockwise".
According to the HSV colour space, the colour wheel is always run through clockwise ($0^\circ \rightarrow 360^\circ$ / red \rightarrow green \rightarrow blue \rightarrow red).

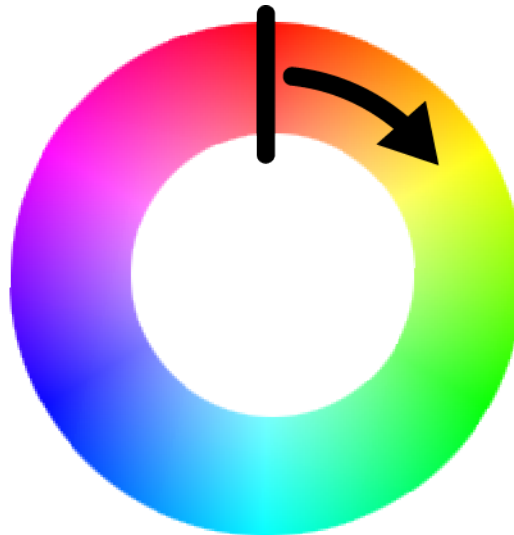

Figure 37: Clockwise colour wheel sequence

- Set the parameter to "anti-clockwise".
According to the HSV colour space, the colour wheel is always run through anti-clockwise ($360^\circ \rightarrow 0^\circ$ / red \rightarrow blue \rightarrow green \rightarrow red).

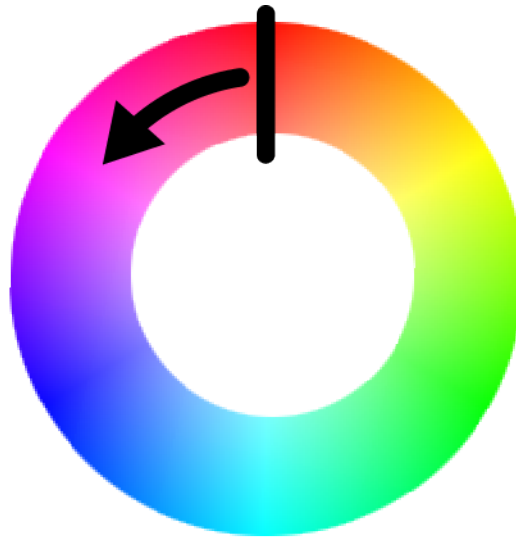

Figure 38: Colour wheel sequence anti-clockwise

- Set the parameter to "toggle".
 When switching over, the gateway automatically changes the direction of the colour wheel sequence after each start (clockwise --> anti-clockwise --> clockwise).

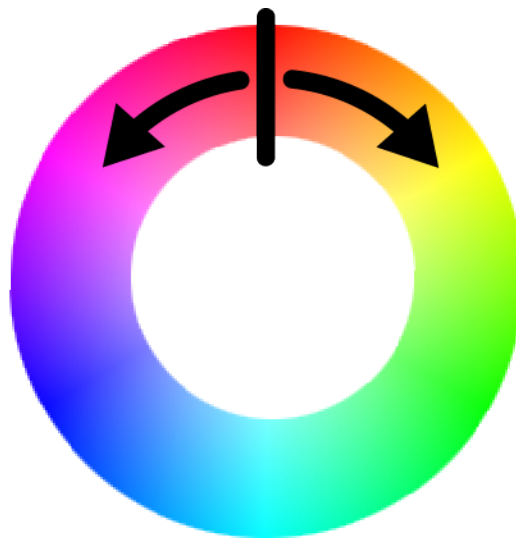

Figure 39: Colour wheel sequence with switching sequence direction

Setting the behaviour at the range limit of the colour wheel sequence

The hue adjustment range is limited to 0° to 360° according to the HSV colour space. The parameter "On reaching the range limit" on the parameter page "DALI system... -> Configuration groups -> [x] Group name -> Colour -> Colour wheel sequence" or "DALI system... -> Configuration single devices -> [x] Device name -> Colour -> Colour wheel sequence" defines the behaviour when the range limit (360° or 0°) is reached.

- Set the parameter to "Stop sequence".

After reaching the range limit 360° or 0° (red), the colour wheel sequence is automatically stopped.

- Set the parameter to "Continue sequence".

After reaching the range limit 360° or 0° (red), the colour wheel sequence is automatically continued until it is stopped by the communication object.

- Set the parameter to "Visualise and continue sequence".

When the range limit 360° or 0° (red) is reached, a short visualisation is carried out by the lamp and then the sequence is continued in the same direction. Visual feedback is provided by briefly switching the assigned DALI operating devices off and on again. The time between OFF and ON is invariably 1 second. No status telegrams are generated by the short switching process.

Setting the total running time of the colour wheel sequence

After starting the colour wheel sequence, the step-by-step run through the HSV colour wheel begins. With each step, the current hue is either increased or decreased depending on the configured sequence direction, converted into an RGB value and transmitted on the DALI line. The number of steps and consequently the increment of the hue is derived from the configured "Total running time", which can be set by the corresponding parameter on the parameter page "DALI system... -> Configuration groups -> [x] Group name -> Colour -> Colour wheel sequence" or "DALI system... -> Configuration single devices -> [x] Device name -> Colour -> Colour wheel sequence".

- Configure the parameter to the desired "total running time".

A colour sequence from 0° to 360° takes the specified time. The longer the total running time, the finer the hue adjustment during the sequence and thus the colour resolution is. The hue increment is calculated by " 360° : total running time [s]".

- i** The total running time exclusively defines the duration and the hue increment of a full colour wheel sequence. It does not specify a start or stop time. A sequence can be stopped before the total running time has elapsed.

9.3.3.1 Parameters for colour wheel sequence

DALI system... -> Configuration groups -> [x] Group name -> Colour -> Colour wheel sequence

DALI system... -> Configuration single devices -> [x] Device name -> Colour -> Colour wheel sequence

Start and stop by	start/stop object (1-bit) dimming object (4-bit)
<p>A sequence is started and stopped by an object whose data format can be configured either to 1-bit or alternatively to 4-bit.</p> <p>Start/Stop object (1 bit): A sequence is started and stopped by the object "Automatic wheel sequence - Start/stop". The data format is set to 1-bit (DPT 1.010). A sequence is started by an ON telegram. A sequence is stopped by an OFF telegram.</p> <p>Dimming object (4 bits): A sequence is started and stopped by the object "Automatic colour wheel sequence - Start/stop". The data format is set to 4-bit (DPT 3.007). A sequence is started by a "Dimming step up or down" telegram. A sequence is stopped by a "Dimming stop" telegram.</p>	
When starting in switched-off state	switch-on no reaction
<p>The adjustment of the hue always starts at the currently set colour if groups or single devices are switched on. When groups or single devices are switched off, the start-up behaviour is determined by this parameter.</p> <p>No reaction: When starting, the affected group or the single device is not switched on. The gateway executes the colour sequence only internally. Only when the brightness is subsequently switched on does the lamp change to the internally tracked colour, but only if the switch-on colour is also configured to "track".</p> <p>Switch-on: Starting a colour wheel sequence immediately switches on a group or single device. In this case, the colour wheel sequence starts at the start value configured by the parameter of the same name.</p>	
Start value	preset value as before last stop
<p>If a group or single device is to be switched on by starting a colour wheel sequence, the sequence starts at a configurable start value.</p> <p>Preset: A fixed start value is specified as the initial hue (optionally with static white value).</p> <p>Value as before last stop: The colour wheel sequence starts at the colour where a stop was performed last in the course of a previous colour wheel sequence.</p> <p>This parameter is available only if the parameter "When starting in switched-off state = switch-on" is configured.</p>	

Colour hue	0°...360°
Setting the start hue value. This parameter is available only in the setting "Start value = preset".	
White value (W)	0...255
Setting the white value of the start value. This parameter is available only in the setting "Start value = preset" in the "RGBW combined", "RGBW individually" and "HSVW" colour spaces.	
Sequence direction	in clockwise direction anti-clockwise toggle
The sequence direction may be either clockwise, anti-clockwise or alternating (toggling). When switching over, the gateway automatically changes the direction of the colour wheel sequence after each start.	
On reaching the range limit	stop sequence continue sequence Visualise and continue the sequence
<p>The hue adjustment range is limited to 0° to 360° according to the HSV colour space. This parameter defines the behaviour when the range limit (360° or 0°) is reached.</p> <p>Stop sequence: After reaching the range limit 360° or 0° (red), the colour wheel sequence is stopped automatically.</p> <p>Continue sequence: After reaching the range limit 360° or 0° (red), the colour wheel sequence is automatically continued until it is stopped by the communication object.</p> <p>Visualise and continue the sequence: When the range limit 360° or 0° (red) is reached, a short visualisation is carried out by the lamp and the sequence is then continued in the same direction. Visual feedback is provided by briefly switching the assigned DALI operating devices off and on again. The time between OFF and ON is invariably 1 second. No status telegrams are generated by the short switching process.</p>	

Total running time	0...23 h 0...59 min 10...30...59 s
--------------------	--

After starting the colour wheel sequence, the step-by-step run through the HSV colour wheel begins. With each step, the current hue is either increased or decreased depending on the configured sequence direction, converted into an RGB value and transmitted on the DALI line. The number of steps and consequently the hue increment is derived from the total running time configured at this point.

A colour sequence from 0° to 360° takes the specified time. The longer the total running time, the finer the hue adjustment during the sequence and thus the colour resolution is. The hue increment is calculated by "360°: total running time [s]".

The total running time exclusively defines the duration and the hue increment of a full colour wheel sequence. It does not specify a start or stop time. A sequence can be stopped before the total running time has elapsed.

9.3.3.2 Objects for colour wheel sequence

Function	Name	Type	DPT	Flag
Automatic colour wheel sequence - Start/stop	Group 1...32 / Single device 1...64	1-bit	1.010	C, -, W, -, U
<p>1-bit object for starting and stopping an automatic colour wheel sequence ("1" = start, "0" = stop).</p> <p>This object is available if the colour wheel sequence is started and stopped by the 1-bit start/stop object.</p>				
Function	Name	Type	DPT	Flag
Automatic colour wheel sequence - Start/stop	Group 1...32 / Single device 1...64	4-bit	3.007	C, -, W, -, U
<p>4-bit object for starting and stopping an automatic colour wheel sequence ("Dimming step up or down" = start, "Dimming stop" = stop).</p> <p>This object is available if colour wheel sequence is to be started and stopped by the 4-bit dimming object.</p>				

9.3.4 Automatic brightness cycle

Introduction

The automatic brightness sequence cyclically adjusts the brightness in the configured brightness range and thus creates individual brightness scenarios. A brightness sequence is available only for groups and single devices that also enable colour control and can be started and stopped at will during the running time of the gateway.

After starting, the automatically controlled step-by-step run through the dimmable brightness range begins. With each step, the current brightness value is either increased or decreased depending on the configured "sequence direction" and transmitted as ARC power level on the DALI line. The number of steps and consequently the brightness value increment is derived from the configured "total running time". The longer the total running time is considered to a full brightness sequence (0...100%), the finer the brightness adjustment during the sequence and thus the resolution is.

When groups or single devices are switched on, the adjustment of the brightness always starts at the currently effective brightness. For switched-off groups or single devices, the start-up behaviour is determined by the parameter "When starting in switched-off state". In this case, it is possible that the start does not switch on the affected group or single device and the gateway executes the brightness curve only internally. Only a subsequent switch-on then switches over the lamps to the internally tracked brightness. Alternatively, starting a brightness sequence can immediately switch on a group or single device in the OFF state. In this case, the brightness sequence then begins at an individual start value. This start value can either be specified as a fixed brightness value in the ETS or, alternatively, it can be set to the brightness at which a stop was last executed in the course of a previous brightness sequence.

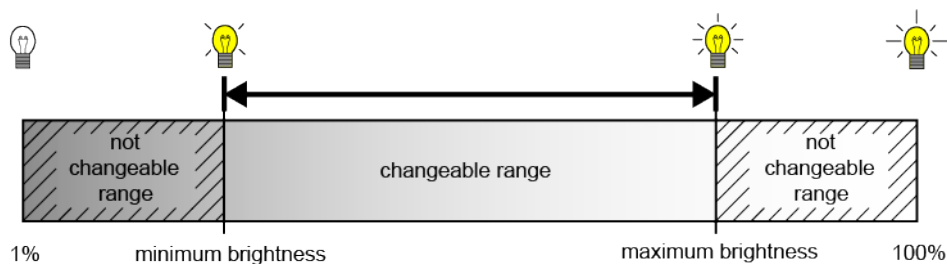

Figure 40: Brightness sequence during automatic brightness sequence

The sequence direction may be either in the direction of lighter, in the direction of darker or alternating (switching the direction by toggling). When switching over, the gateway automatically changes the direction of the brightness sequence after each start. The range of brightness adjustment is limited according to the configured minimum and maximum brightness. It can be defined in the ETS whether the brightness sequence is stopped or continued in the opposite direction after reaching the range limits (maximum brightness or minimum brightness). Optionally, it is possible to carry out a short visualisation by the lamp when a range limit is reached, in order to then

continue the sequence in the opposite direction. This visual feedback is provided by briefly switching the assigned DALI operating devices off and on again. The time between OFF and ON is invariably 1 second.

A brightness sequence always stops as soon as a stop command is received via the KNX communication object "Automatic brightness sequence - Start/Stop". The brightness last set by the brightness sequence is initially retained until it is changed by a new brightness sequence or by other functions of the gateway. A sequence is started and stopped by an object whose data format can be configured either to 1-bit (DPT 1.010 / "1" = start, "0" = stop) or alternatively to 4-bit (DPT 3.007 / "Dimming step up or down" = start, "Dimming stop" = stop).

- i** The specified brightness range is always run through according to the effective brightness value of a group or single device (by DALI ARC power level). The configured colour space has no influence on this.
- i** A brightness sequence does not affect the colour. However, the colour can also be changed by the communication objects provided during a brightness sequence. However, an automatic colour wheel sequence cannot run simultaneously.

Setting the start/stop behaviour of the brightness sequence

The parameter "Start and stop by" on the parameter page "DALI system... -> Configuration groups -> [x] Group name -> Colour -> Brightness sequence" or "DALI system... -> Configuration single devices -> [x] Device name -> Colour -> Brightness sequence" specifies the data format of the communication object for starting and stopping the automatic brightness sequence.

- Set the parameter to "Start/Stop object (1 bit)".
A sequence is started and stopped by the object "Automatic brightness sequence - Start/stop". The data format is set to 1-bit (DPT 1.010). A sequence is started by an ON telegram. A sequence is stopped by an OFF telegram.
- Set the parameter to "Dimming object (4-bit)".
A sequence is started and stopped by the object "Automatic brightness sequence - Start/stop". The data format is set to 4-bit (DPT 3.007). A sequence is started by a "Dimming step up or down" telegram. A sequence is stopped by a "Dimming stop" telegram.
- i** Changes to the brightness with the object "Brightness value - Setting" stop a running brightness sequence. The brightness sequence is also stopped when the affected group or single device is switched off (brightness 0%).
- i** The colour wheel sequence and brightness sequence cannot run at the same time. As soon as the brightness sequence has been started, the colour wheel sequence is automatically stopped. The same applies vice versa. It is not permissible to link the start/stop objects of both functions of a group or single device with identical group addresses!

- i** During an activated lock or forced position, a started brightness sequence has no effect. If the parameter for specifying the behaviour of the brightness at the end of the disabling function is configured to the "track" setting, the tracked brightness of a current brightness sequence is set at the end of disabling, provided the group or single device concerned is switched on. If no brightness tracking is configured at the end of the disabling, the automatic brightness sequence is stopped.
- i** During an active manual operation, a started brightness sequence has no effect. At the end of a manual operation, the tracked brightness of a current brightness sequence is set. A valid scene recall stops the automatic brightness sequence. After an ETS programming operation, a brightness sequence is always stopped.
- i** No brightness or switching status telegrams are generated during a brightness sequence (not even during a continuous sequence after reaching the brightness limit values and direction reversal). Only when a sequence is stopped does the gateway send out the current brightness as a status.
- i** If several brightness sequences occur simultaneously in different groups or single devices, this can lead to an overload of the DALI system, which means that calculated brightness values cannot always be reliably transmitted to the operating devices.

Setting the start behaviour of the brightness sequence in the switched-off state

When groups or single devices are switched on, the adjustment of the brightness always starts at the currently effective brightness. When groups or single devices are switched off, the start-up behaviour is determined by the parameter "When starting in switched-off state" on the parameter page "DALI system... -> Configuration groups -> [x] Group name -> Colour -> Brightness sequence" or "DALI system... -> Configuration single devices -> [x] Device name -> Colour -> Brightness sequence".

- Set the parameter to "No reaction".
When starting, the affected group or single device is not switched on. The gateway ignores the start of the brightness sequence.
- Set the parameter to "Switch-on".
Starting a brightness sequence immediately switches on a group or single device. In this case, the brightness sequence then begins at the start value configured by the parameter of the same name.
- Set the "Start value" parameter to "preset".
A fixed start value is preset as the initial brightness value. Make sure the configured brightness value is not below the set minimum brightness or above the maximum brightness! Otherwise, the gateway will limit the start value to minimum or maximum brightness.
- Set the "Start value" parameter to "memory value (value as before last switch-off)".

When starting, the brightness value that was active and stored internally before the last switch-off is set. This memory value is stored in a non-volatile manner in the gateway so that the value is retained after the bus or mains voltage returns. After programming with the ETS, the value is predefined to maximum brightness.

- Set the "Start value" parameter to "value as before last stop".
The brightness sequence starts at the brightness value at which a stop was last executed in the course of the previous brightness sequence.

Setting the direction of the brightness sequence

The "Sequence direction" parameter on the parameter page "DALI system... -> Configuration groups -> [x] Group name -> Colour -> Brightness sequence" or "DALI system... -> Configuration single devices -> [x] Device name -> Colour -> Brightness sequence" defines the sequence direction of an automatic brightness sequence after starting.

- Set the parameter to "brighter".
After starting, the brightness range is first run through in the direction of "brighter".



Figure 41: Brightness sequence direction "brighter"

- Set the parameter to "darker".
After starting, the brightness range is initially run through in the direction of "darker".

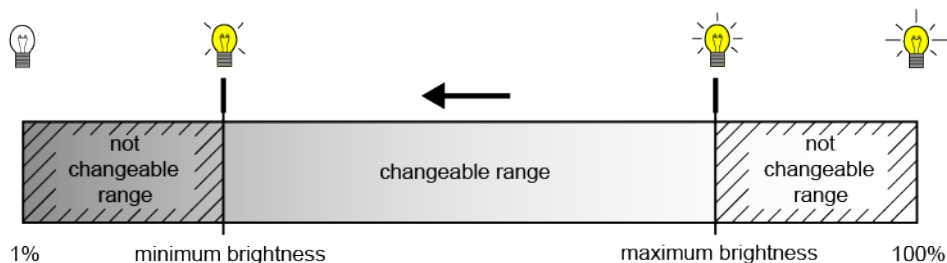

Figure 42: Brightness sequence direction "darker"

- Set the parameter to "toggle".
When switching over, the gateway automatically changes the direction of the brightness sequence after each start.

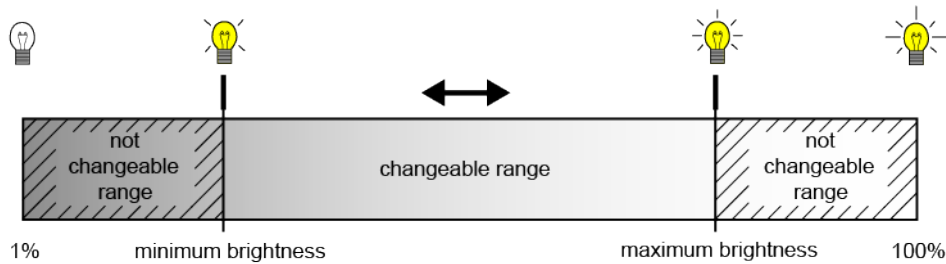

Figure 43: Brightness sequence with switching sequence direction

- i** The parameter "When reaching the range limit" determines whether the direction of brightness adjustment is reversed at the end of the range (maximum or minimum brightness) or whether the automatic adjustment ends.

Setting the behaviour at the range limit of the brightness sequence

The range of brightness adjustment is limited by the minimum brightness and maximum brightness. The parameter "On reaching the range limit" on the parameter page "DALI system... -> Configuration groups -> [x] Group name -> Colour -> Brightness sequence" or "DALI system... -> Configuration single devices -> [x] Device name -> Colour -> Brightness sequence" defines the behaviour when the range limits are reached.

- Set the parameter to "Stop sequence".
The brightness sequence is automatically stopped after reaching the range limits defined by the minimum brightness and maximum brightness.
- Set the parameter to "Reverse direction and continue sequence".
After the range limits are reached, the direction is reversed and the adjustment is automatically continued in the opposite direction until it is stopped by the communication object.
- Set the parameter to "Visualise, reverse direction and continue sequence".
When the range limits are reached, a short visualisation is carried out by the lamp and then the sequence is continued in the opposite direction. Visual feedback is provided by briefly switching the assigned DALI operating devices off and on again. The time between OFF and ON is invariably 1 second. No status telegrams are generated by the short switching process.

Setting the total running time of the brightness sequence

After starting the brightness sequence, the step-by-step run through the configured brightness range begins. With each step, the current brightness value is either increased or decreased depending on the configured sequence direction and transmitted as ARC power level on the DALI line. The number of steps and consequently the increment of the brightness value is derived from the configured total running time, which can be set by the parameter of the same name on the parameter page "DALI system... -> Configuration groups -> [x] Group name -> Colour -> Brightness sequence" or "DALI system... -> Configuration single devices -> [x] Device name -> Colour -> Brightness sequence".

- Configure the parameter to the desired "total running time".

A brightness sequence from 1% to 100% takes the specified time. The longer the total running time, the finer the brightness adjustment during the sequence and thus the resolution is. The brightness value increment is calculated by "100% : total running time [s]".

- If the brightness range has been limited by setting a minimum brightness greater than 1% and a maximum brightness less than 100%, the effective running time of the brightness sequence is correspondingly shorter than the configured total running time.

i The total running time exclusively defines the duration and the brightness value increment of a full brightness sequence. It does not specify a start or stop time. A sequence can be stopped before the total running time has elapsed.

9.3.4.1 Parameters for brightness sequence

DALI system... -> Configuration groups -> [x] Group name -> Colour -> Brightness sequence

DALI system... -> Configuration single devices -> [x] Device name -> Colour -> Brightness sequence

Start and stop by	start/stop object (1-bit) dimming object (4-bit)
<p>A sequence is started and stopped by an object whose data format can be configured either to 1-bit or alternatively to 4-bit.</p> <p>Start/stop object (1 bit): A sequence is started and stopped by the "Automatic brightness run - Start/stop" object. The data format is set to 1-bit (DPT 1.010). A sequence is started by an ON telegram. A sequence is stopped by an OFF telegram.</p> <p>Dimming object (4-bit): A sequence is started and stopped by the "Automatic brightness sequence - Start/stop" object. The data format is set to 4-bit (DPT 3.007). A sequence is started by a "Dimming step up or down" telegram. A sequence is stopped by a "Dimming stop" telegram.</p>	
When starting in switched-off state	switch-on no reaction
<p>When groups or single devices are switched on, the adjustment of the brightness always starts at the currently effective brightness. When groups or single devices are switched off, the start-up behaviour is determined by this parameter.</p> <p>No reaction: When starting, the affected group or the single device is not switched on. The gateway ignores the start of the brightness sequence.</p> <p>Switch-on: A fixed start value is preset as the start brightness value.</p>	

Start value	preset memory value (value bef. switching-off last time) value as before last stop
<p>If a group or single device is to be switched on by starting a brightness sequence, the sequence starts at a configurable start value.</p> <p>Preset: A fixed start value is preset as the start brightness value. Make sure the configured brightness value is not below the set minimum brightness or above the maximum brightness! Otherwise, the gateway will limit the start value to minimum or maximum brightness.</p> <p>Memory value (value before switching-off last time): When starting, the brightness value that was active and stored internally before the last switch-off is set. This memory value is stored in a non-volatile manner in the gateway so that the value is retained after the bus or mains voltage returns. After programming with the ETS, the value is predefined to maximum brightness.</p> <p>Value as before last stop: The brightness sequence starts at the brightness value at which a stop was last executed during the previous brightness sequence.</p> <p>This parameter is available only if the parameter "When starting in switched-off state = switch-on" is configured.</p>	
Brightness value	1%, 2%, 3%, 4%, 5%, 6%, 7%, 8%, 9%, 10%, 15%, 20%... 50% ...100%
<p>Setting of the start brightness value.</p> <p>This parameter is available only in the setting "Start value = preset".</p>	
Sequence direction	brighter darker toggle
<p>The sequence direction may be either in the direction of lighter, in the direction of darker or alternating (switching the direction by toggling). When switching over, the gateway automatically changes the direction of the brightness sequence after each start.</p>	

On reaching the range limit	stop sequence reverse direction and continue sequence visualise, reverse direction and continue sequence
<p>The range of brightness adjustment is limited to the range between the configured minimum brightness and maximum brightness. This parameter defines the behaviour when the range limits are reached.</p> <p>Stop sequence: The brightness sequence is automatically stopped after reaching the range limits.</p> <p>Reverse direction and continue sequence: After reaching the range limits, the brightness sequence is automatically continued in opposite direction until it is stopped by the communication object.</p> <p>Visualise, reverse direction and continue sequence: When the range limits are reached, a short visualisation is carried out by the lamp and the sequence is then continued in the opposite direction. Visual feedback is provided by briefly switching the assigned DALI operating devices off and on again. The time between OFF and ON is invariably 1 second. No status telegrams are generated by the short switching process.</p>	
Total running time	0...23 h 0...59 min 10...30...59 s
<p>After starting the brightness sequence, the step-by-step run through the predefined brightness range begins. With each step, the effective brightness value is either increased or decreased depending on the configured sequence direction and transmitted as ARC power level on the DALI line. The number of steps and consequently the brightness value increment is derived from the total running time parameterised at this point.</p> <p>A brightness sequence from 1% to 100% takes the specified time. The longer the total running time, the finer the brightness adjustment during the sequence and thus the resolution is. The brightness value increment is calculated by "100% : total running time [s]".</p> <p>If the brightness range has been limited by setting a minimum brightness greater than 1% and a maximum brightness less than 100%, the effective running time of the brightness sequence is correspondingly shorter than the configured total running time.</p> <p>The total running time exclusively defines the duration and the brightness value increment of a full brightness sequence. It does not specify a start or stop time. A sequence can be stopped before the total running time has elapsed.</p>	

9.3.4.2 Objects for brightness sequence

Function	Name	Type	DPT	Flag
Automatic brightness sequence - Start/stop	Group 1...32 / Single device 1...64	1-bit	1.010	C, -, W, -, U
<p>1-bit object for starting and stopping an automatic brightness sequence ("1" = start, "0" = stop).</p> <p>This object is available if the brightness sequence is to be started and stopped by a 1-bit start/stop object.</p>				

Function	Name	Type	DPT	Flag
Automatic brightness sequence - Start/stop	Group 1...32 / Single device 1...64	4-bit	3.007	C, -, W, -, U
<p>4-bit object for starting and stopping an automatic brightness sequence ("Dimming step up or down" = start, "Dimming stop" = stop).</p> <p>This object is available if the brightness sequence is to be started and stopped by a 4-bit dimming object.</p>				

9.3.5 Colour Transition Mode (CTM)

Introduction

The Colour Transition Mode (CTM) implements colour gradients for the implementation of different colour moods depending on the time of day and day of the week. Up to four freely configurable CTM matrices are available for this purpose. Each matrix allows the setting of individual daytime colour gradients, with or without brightness adjustment. The matrices can be activated and switched over individually during operation of the gateway.

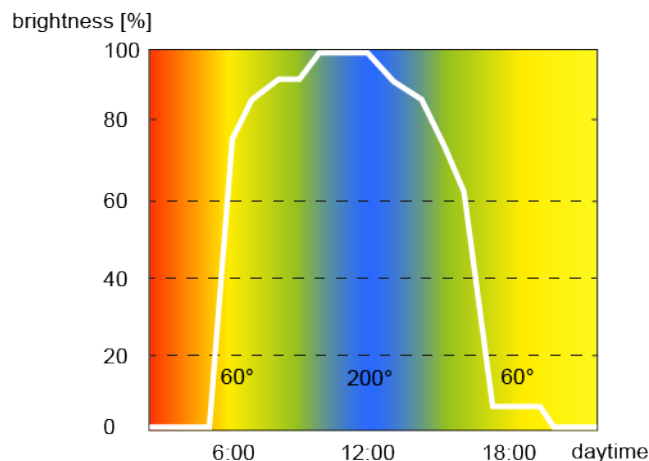

Figure 44: Exemplary daytime colour sequence with colour and brightness adjustment

The colour adjustment of a CTM matrix is basically done by means of the hue of the HSV colour space. As with dimming, the brightness is adjusted by means of the DALI ARC power level. Each CTM matrix contains settings for the hue (0...360°) and brightness (0...100%) for each full hour of the daytime (0:00 midnight, 1:00 a.m., 2:00 a.m....11:00 p.m.). The individual colour and brightness values are called up in sequence, depending on the time. The values between two full hours are determined continuously every minute by linear interpolation to implement a smooth colour and brightness progression.

Whether a daytime colour sequence only influences the colour or also the brightness during operation can be defined individually for each group and single device in the parameterisation.

Examples of linear interpolation of hues and brightness values

Time: 8:00 a.m., hue: 180°
 Time: 9:00 a.m., hue: 210°
 --> Time: 8:30 a.m., hue: 195°
 Time: 10:00 a.m., brightness: 50%
 Time: 11:00 a.m., brightness: 80%
 --> Time: 10:30 a.m., brightness: 65%

The sequence of a daytime colour sequence always takes place according to the hue of the HSV colour space, regardless of which colour space is configured for the assigned group or single device. The colour specified by the hue is automatically converted by the gateway into an equivalent RGB value and forwarded to the DALI operating devices.

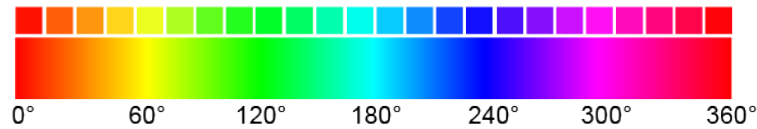

Figure 45: Colours in the HSV hue

- i** During a daytime colour sequence, the values for colour saturation and brightness remain constant at the maximum value (100%). Only the hue is adjusted. An optional white component (W) is switched off (0%).
- i** An active daytime colour sequence influences the colour and optionally also the brightness of a group or single device. The CTM function of the gateway triggers status telegrams for the colour and brightness separately if there are changes in the values in the course of a start or a running matrix. Here, the evaluation takes place every minute.

The CTM matrices are generally configured centrally for all groups and single devices of a DALI system. For the parameters of the groups and single devices, the individual assignment to up to four matrices takes place. During operation of the gateway, the matrix assignments of groups and single devices can be switched over by 1-byte objects. This allows the pre-programmed daytime colour sequences to be switched over individually depending on the application.

The daytime colour sequence of a group or single device can be started and stopped individually. A 1-bit communication object "Daytime colour sequence (CTM) - Start/stop" is available for each group and single device for this purpose. When activated by an ON telegram, the execution of the daytime colour sequence starts according to the current time and day of the week. When deactivated by an OFF telegram, the execution of the daytime colour sequence is immediately terminated. The DALI operating devices then initially remain at the last set colour and brightness value.

A daytime colour sequence can be executed with or alternatively without brightness adjustment. In a CTM matrix, the colour and brightness values are always configured for each time. Whether a group or single device reacts only to the pre-programmed colour or additionally to the defined brightness value is defined by the parameter "Type of daytime colour sequence" parameter. If the daytime colour sequence is carried out only with colour adjustment, the gateway only takes into account the colour value of the CTM matrix corresponding to the day of the week and the time of day. If a brightness adjustment is also to be made, the stored CTM brightness value is also executed.

A daytime colour sequence is of the same priority as the normal control of the brightness and colour of a group or single device by the corresponding communication objects. An automatic colour wheel sequence, an automatic brightness sequence or a scene recall also has the same priority. The above functions override a daytime col-

our sequence in progress in terms of colour and brightness. In the event of an override, a daytime colour sequence in progress can be stopped automatically, or alternatively continue to run in the background.

- i** During an activated lock or forced position, any started daytime colour sequence has no effect. If the parameter for specifying the behaviour of the colour or brightness at the end of a disabling function is configured to the setting "track", the tracked colour and optionally also the brightness of a daytime colour sequence in progress is set at the end of disabling. If colour or brightness tracking is not configured at the end of disabling, the values are not tracked. A daytime colour sequence that continues to run is then processed normally every minute depending on the time. The same applies in principle when revoking a forced position.
- i** During an active manual operation, any started daytime colour sequence has no effect. The behaviour at the end of a manual operation is different for temporary and permanent manual operation modes. At the end of a permanent manual operation, the configuration decides whether the colour and optionally also the brightness of a daytime colour sequence in progress is tracked or not. If tracking is not automatically performed, a daytime colour sequence that continues to run is processed normally at minute intervals depending on the time after a temporary manual operation. A daytime colour sequence is always stopped after an ETS programming operation.
- i** No times or days of the week are updated if the gateway has not yet received any or a valid KNX telegram to set the internal clock after initialisation (after the mains voltage returns or an ETS programming operation). In this case, the daytime colour sequence has no function!

Setting the designation of the CTM matrices

Up to four freely configurable CTM matrices are available for Colour Transition Mode (CTM). Each matrix can be given a designation, which is visible only in the ETS for better identification.

- On the parameter pages "DALI system... -> Colour - CTM -> CTM matrix...", assign a "designation" to each matrix.

Setting daytime colour sequences in the CTM matrices

Each CTM matrix contains settings for the hue (0°...360°) and brightness (0...100%) for each full hour of the daytime (0:00 midnight, 1:00 a.m., 2:00 a.m....11:00 p.m.) on the parameter pages "DALI system... -> Colour - CTM -> CTM matrix...". Depending on the time of day, the individual colour and brightness values are called up one after the other as the daytime colour sequence runs down. The values between two full hours are determined continuously every minute by linear interpolation to implement a smooth colour and brightness progression.

- Configure the parameters for "hue" and "brightness" to the desired values for each time.

- i** In a CTM matrix, the colour and brightness values are always configured for each time. Whether a group or single device reacts only to the pre-programmed colour or additionally to the defined brightness value is defined by the parameter "Type of daytime colour sequence" on the parameter pages of the groups and single devices.
- i** The brightness values stored in a CTM matrix can always be configured within the range of 0...100%. If CTM brightness values are outside the brightness range defined by minimum and maximum brightness of assigned groups or single devices, the gateway limits the brightness to the specified limits when a daytime colour sequence is in progress.
- i** The additionally controllable white value (W) available in the "RGBW..." or "HSVW..." colour spaces is always switched off (0%) in the course of a daytime colour sequence.

Setting the effective matrix after an ETS programming operation

The parameter "After ETS programming operation" on the parameter page "DALI system... -> Configuration groups -> [x] Group name -> Colour -> CTM" or "DALI system... -> Configuration single devices -> [x] Device name -> Colour -> CTM" defines which of the up to four CTM matrices is initially effective for the affected group or single device after the gateway has been commissioned by the ETS or after a reset. Optionally, the matrix assignments can be switched by 1-byte objects during operation of the gateway.

- Set the parameter to the desired CTM matrix.
After an ETS programming operation or mains voltage return, the configured CTM matrix is effective. However, it is executed only when a start takes place.

Enabling switching of the effective matrix during operation

During operation of the gateway, the matrix assignments of groups and single devices can be switched over by 1-byte objects. This allows the pre-programmed daytime colour sequences to be switched over individually depending on the application.

- Activate the "Switchable via object" parameter on the parameter page "DALI system... -> Configuration groups -> [x] Group name -> Colour -> CTM" or "DALI system... -> Configuration single devices -> [x] Device name -> Colour -> CTM".
The 1-byte communication object "Daytime colour sequence (CTM) - Switch matrix" is available. According to KNX DPT 17.001, a switchover can be performed by the number of the matrix (1...4) during operation of the gateway.
- Deactivate the parameter "Switchable via object".
No communication object is available for switching the CTM matrices during operation. The CTM matrix defined by the parameter "After ETS programming operation" always remains effective.

- i** It is always possible to switch over a CTM matrix during operation of the gateway. A switchover in the "Daytime colour sequence stopped" state is saved by the gateway. At the next start, the gateway then executes the last switched CTM matrix for the affected group or single device. When switching in the state "Daytime colour sequence started", the gateway executes the switched matrix every minute according to the time. The switched matrix therefore takes effect no later than one minute after the switchover.
- i** In principle, it is only possible to switch to the four CTM matrices configured in the ETS. There is no reaction if a matrix number (5...64) is received by means of the switch-over object not included in the configuration of the matrices.
- i** After an ETS programming operation or the mains voltage returns, the last switchover by means of the object is lost (object value "0"). A new telegram must first be received so that a new switchover becomes active.

Setting the type of daytime colour sequence

A daytime colour sequence can be executed with or alternatively without brightness adjustment. Whether a group or single device reacts only to the pre-programmed colour or additionally to the defined brightness value of the CTM matrix is determined by the parameter "Type of daytime colour sequence" on the parameter page "DALI system... -> Configuration groups -> [x] Group name -> Colour -> CTM" or "DALI system... -> Configuration single devices -> [x] Device name -> Colour -> CTM".

- Set the parameter "Type of daytime colour sequence" to "only colour adjustment".

In this case, the gateway only takes into account the colour value of the CTM matrix corresponding to the day of the week and the time. The brightness value stored in the matrix is ignored. The brightness can then be controlled by other functions of the gateway (e.g. by switching and dimming or by the automatic brightness sequence).

- Set the parameter "Type of daytime colour sequence" to "colour and brightness adjustment".

In addition to evaluating the configured colours of the CTM matrices, the gateway also evaluates the stored brightness values.

Setting the behaviour in case of overriding

A daytime colour sequence is of the same priority as the normal control of the brightness and colour of a group or single device by the corresponding communication objects. An automatic colour wheel sequence, an automatic brightness sequence or a scene recall also has the same priority. The above functions override a daytime colour sequence in progress in terms of colour and brightness. In the event of an override, a daytime colour sequence in progress can be stopped automatically, or alternatively continue to run in the background. The behaviour is defined by the parameter "Behaviour in case of overload" parameter on the parameter page "DALI system... -> Configuration groups -> [x] Group name -> Colour -> CTM" or "DALI system... -> Configuration single devices -> [x] Device name -> Colour -> CTM".

- Set the parameter "Behaviour in case of overload" to "CTM continues to work".

An ongoing daytime colour sequence can be overridden at any time by other functions of the gateway. However, the daytime colour sequence continues to run, whereby the values stored in the CTM matrix continue to be called up continuously every minute, depending on the time. In this case, the last received or given commands for the colour or brightness of other functions (e.g. scene recall) are replaced by the CTM values again after one minute at the latest.

For daytime colour gradients with brightness adjustment, the brightness values defined in the CTM matrix are tracked. The gateway then continues to process the interpolated brightness values every minute and, if necessary, switches on any operating devices that have been switched off.

With daytime colour sequences without brightness adjustment, the colour is internally tracked by the CTM matrix even if groups or single devices are switched off. If a group or single device is switched on, the gateway sets the tracked colour so that DALI operating devices subsequently switched on display the correct values of the daytime colour sequence.

- Set the parameter "Behaviour in case of overload" to "CTM is terminated".

If a daytime colour sequence is automatically stopped by an override, the gateway immediately stops processing the assigned CTM matrix.

Defining effective weekdays

The Colour Transition Mode (CTM) implements colour gradients for the implementation of different colour moods depending on the time of day and day of the week. The individual colour and brightness values are called up in sequence, depending on the time. However, this is done only on selected weekdays. On which days of a week a daily colour sequence is to be executed can be defined in the ETS configuration.

- Set the selection of the effective weekdays on the parameter page "DALI system... -> Configuration groups -> [x] Group name -> Colour -> CTM" or "DALI system... -> Configuration single devices -> [x] Device name -> Colour -> CTM".

A started daytime colour sequence is executed only on the configured weekdays. The daytime colour sequence is paused on days of a week not included in the selection.

- i** If the KNX telegram for setting the internal clock contains the information "all days", the gateway no longer evaluates a discrete weekday and only carries out the day colour sequence cyclically every day according to the stored times.

9.3.5.1 Parameters for Colour Transition Mode (CTM)

DALI system... -> Colour - CTM -> CTM matrix ...

Name	Colour gradient...
Each matrix can be given a designation, which is visible only in the ETS for better identification.	
Brightness	0...100%
Colour hue	0...360°
<p>Each CTM matrix contains settings for the hue (0°...360°) and brightness (0...100%) for each full hour of the daytime (0:00 midnight, 1:00 a.m., 2:00 a.m....11:00 p.m.). Depending on the time of day, the individual colour and brightness values are called up one after the other as the daytime colour sequence runs down. The values between two full hours are determined continuously every minute by linear interpolation to implement a smooth colour and brightness progression.</p> <p>In a CTM matrix, the colour and brightness values are always configured for each time. Whether a group or single device reacts only to the pre-programmed colour or additionally to the defined brightness value is defined by the parameter "Type of daytime colour sequence" on the parameter pages of the groups and single devices.</p> <p>The brightness values stored in a CTM matrix can always be configured within the range of 0...100%. If CTM brightness values are outside the brightness range defined by minimum and maximum brightness of assigned groups or single devices, the gateway limits the brightness to the specified limits when a daytime colour sequence is in progress.</p> <p>During a daytime colour sequence, the values for colour saturation and brightness remain constant at the maximum value (100%). Only the hue is adjusted.</p> <p>The parameters "brightness" and "hue" are available for each full hour of a CTM matrix. The default setting of the parameters depends on the time.</p>	

DALI system... -> Configuration groups -> [x] Group name -> Colour -> CTM

DALI system... -> Configuration single devices -> [x] Device name -> Colour -> CTM

after ETS programming operation	CTM matrix 1 CTM matrix 2 CTM matrix 3 CTM matrix 4
<p>This parameter defines which of the up to four CTM matrices is initially effective for the affected group or single device after the gateway has been commissioned by the ETS or after a reset. Optionally, the matrix assignments can be switched by 1-byte objects during operation of the gateway.</p> <p>After an ETS programming operation or mains voltage return, the configured CTM matrix is effective. However, it is executed only when a start takes place.</p>	

Switchable via object	Checkbox (yes/no)
<p>During operation of the gateway, the matrix assignments of groups and single devices can be switched over by 1-byte objects. This allows the pre-programmed daytime colour sequences to be switched over individually depending on the application.</p> <p>Checkbox selected: The 1-byte communication object "Daytime colour sequence (CTM) - Switch matrix" is available. According to KNX DPT 17.001, a switchover can be performed by the number of the matrix (1...4) during operation of the gateway.</p> <p>Checkbox deselected: No communication object is available for switching the CTM matrices during operation. The CTM matrix defined by the parameter "After ETS programming operation" always remains effective.</p>	
Type of daytime colour sequence	only colour adjustment Colour and brightness adjustment
<p>A daytime colour sequence can be executed with or alternatively without brightness adjustment. Whether a group or single device reacts only to the pre-programmed colour or additionally to the defined brightness value of the CTM matrix is defined by this parameter.</p> <p>Only colour adjustment: In this case, the gateway only takes into account the colour value of the CTM matrix corresponding to the day of the week and the time. The brightness value stored in the matrix is ignored. The brightness can then be controlled by other functions of the gateway (e.g. by switching and dimming or by the automatic brightness sequence).</p> <p>Colour and brightness adjustment: In addition to evaluating the configured colours of the CTM matrices, the gateway also evaluates the stored brightness values.</p>	

Behaviour in case of overload	CTM continues to work CTM is terminated
<p>A daytime colour sequence is of the same priority as the normal control of the brightness and colour of a group or single device by the corresponding communication objects. An automatic colour wheel sequence, an automatic brightness sequence or a scene recall also has the same priority. The above functions override a daytime colour sequence in progress in terms of colour and brightness.</p> <p>In the event of an override, a daytime colour sequence in progress can be stopped automatically, or alternatively continue to run in the background. The behaviour is defined by this parameter.</p> <p>CTM continues to operate: An ongoing daytime colour sequence can be overridden at any time by other functions of the gateway. However, the daytime colour sequence continues to run, whereby the values stored in the CTM matrix continue to be called up continuously every minute, depending on the time. In this case, the last received or given commands for the colour or brightness of other functions (e.g. scene recall) are replaced by the CTM values again after one minute at the latest. For daytime colour gradients with brightness adjustment, the brightness values defined in the CTM matrix are tracked. The gateway then continues to process the interpolated brightness values every minute and, if necessary, switches on any operating devices that have been switched off. With daytime colour sequences without brightness adjustment, the colour is internally tracked by the CTM matrix even if groups or single devices are switched off. If a group or single device is switched on, the gateway sets the tracked colour so that DALI operating devices subsequently switched on display the correct values of the daytime colour sequence.</p> <p>CTM is terminated: If a daytime colour sequence is automatically stopped by an override, the gateway immediately stops processing the assigned CTM matrix.</p>	
Selection of effective weekdays	Checkboxes (Mon, Tue, Wed, Thu, Fri, Sat, Sun)
<p>The Colour Transition Mode (CTM) implements colour gradients for the implementation of different colour moods depending on the time of day and day of the week. The individual colour and brightness values are called up in sequence, depending on the time. However, this is done only on selected weekdays. In the ETS configuration, it can be defined at this point on which days of a week a daily colour sequence is executed.</p> <p>A started daytime colour sequence is executed only on the configured weekdays. The daytime colour sequence is paused on days of a week not included in the selection.</p>	

9.3.5.2 Objects for Colour Transition Mode (CTM)

Function	Name	Type	DPT	Flag
Daytime colour sequence (CTM) - Start/stop	Group 1...32 / Single device 1...64	1-bit	1.003	C, -, W, -, U
<p>1-bit object for starting and stopping a daytime colour sequence ("1" = start, "0" = stop).</p> <p>After the start, the execution of the daytime colour sequence begins according to the current time and day of the week. When stopped, the execution of the daytime colour sequence is immediately stopped.</p>				
Function	Name	Type	DPT	Flag
Daytime colour sequence (CTM) - Switch matrix	Group 1...32 / Single device 1...64	1-byte	17.001	C, -, W, -, U
<p>1-byte object for switching the effective CTM matrix (1...4) during operation of the gateway.</p> <p>In principle, it is only possible to switch to the four CTM matrices configured in the ETS. There is no reaction if a matrix number (5...64) is received by means of the switch-over object not included in the configuration of the matrices.</p> <p>After an ETS programming operation or the mains voltage returns, the last switchover by means of the object is lost (object value "0"). A new telegram must first be received so that a new switchover becomes active.</p>				

9.4 Response after a device reset

The switching states or brightness values that set themselves after a bus voltage failure, bus or mains voltage return or after an ETS programming operation for DALI groups or single devices can be configured in the ETS. The behaviour of the colour temperature of the colour of a group or single device is unalterably predefined in the case of a device reset.

The configuration options and permanently defined functions are described below.

Setting the behaviour of the brightness in case of bus voltage failure

The parameter "In case of bus/mains voltage failure" is separately available for each group and single device in the parameter node "DALI system... -> Configuration groups -> [x] Group name" or "DALI system... -> Configuration single devices -> [x] Device name".

- Set the parameter to "no reaction".
In the event of a bus or mains voltage failure, the gateway does not send any commands to the DALI operating devices. The assigned DALI operating devices, provided their mains voltage supply is still switched on, show no response and remain in the brightness state that was last set.
- Set the parameter to "Switch off".
The DALI operating devices are switched off via the DALI cable in the case of a bus voltage failure if the mains voltage supply of the gateway is still switched on. If the mains voltage fails at the gateway, this command can no longer be issued. Here, too, the DALI operating devices set themselves to the programmed system failure level that corresponds to this parameter, provided their mains voltage supply is still switched on.
- Set the parameter to "Brightness value". Configure the required value in the following parameter "Brightness value".
In the event of a bus voltage failure at the gateway, the DALI operating devices are set via the DALI line to the value specified by the "Brightness value" parameter, provided the mains voltage supply of the gateway is still switched on. If the mains voltage fails at the gateway, this command can no longer be issued. In this case, the DALI operating devices set themselves to the programmed system failure level corresponding to this parameter, provided their mains voltage supply is still switched on.

The selection of the configurable brightness value is not limited at the limits by the specified minimum and maximum brightness. If brightness values lower than the minimum brightness or higher than the maximum brightness are set, the gateway sets the brightness to the configured minimum and maximum limit values.

- i** If there is a voltage failure on the DALI cable (e.g. due to short-circuit, cable break, mains voltage failure on gateway), then the assigned DALI operating devices will also show the configured behaviour in the event of a bus voltage

failure. This is guaranteed because the parameter setting in the DALI operating devices is applied as the "System Failure Level" for the brightness after an ETS programming operation.

- i** In the event of a bus failure or mains voltage failure, the current states of the forced positions are also saved so that they can be tracked in the event of bus or mains voltage return if necessary (depending on the configuration of the forced positions).
- i** Active disabling functions or forced position functions are always cancelled by a bus voltage failure and are subsequently inactive in the connection.

Setting the behaviour of the brightness after bus voltage return

The parameter "After bus/mains voltage return" is separately available for each group and single device in the parameter node "DALI system... -> Configuration groups -> [x] Group name" or "DALI system... -> Configuration single devices -> [x] Device name".

- Set the parameter to "no reaction".

After bus or mains voltage return, the gateway does not transmit any commands to the DALI operating devices. The assigned DALI operating devices show no response and remain in the brightness state that was last set (also see the note on "Power-On Level" further below).
- i** In this state, no colour temperature control or colour control is possible after bus or mains voltage return even if the devices are still switched on due to the last brightness state. In this case, the group or single device concerned must either be switched off and switched on again after bus or mains voltage return or must be preset to a brightness value unequal "0 %" by a new telegram. Only in this way does the gateway evaluate the state "ON" for the operating devices and permits a control of the colour temperature or colour by new commands.
- Set the parameter to "Switch off".

The DALI operating devices are switched off on bus/mains voltage return via the DALI cable.
- Set the parameter to "brightness before bus/mains voltage failure".

After bus or mains voltage return, the brightness value set most recently before the bus or mains voltage failure and saved internally on bus/mains voltage failure will be tracked.
- Set the parameter to "Brightness value". Configure the required value in the following parameter "Brightness value".

The DALI operating devices are set to the predefined brightness value via the DALI cable. The selection of the configurable value is not limited at the limits by the specified minimum and maximum brightness. If brightness values lower

than the minimum brightness or higher than the maximum brightness are set, the gateway sets the brightness to the configured minimum and maximum limit values.

- Preset parameter to "Activate staircase function".

The staircase function is activated – irrespective of the object " 'Staircase function - Start/Stop" - after bus or mains voltage return.

- i** After mains voltage return, the gateway initialises the configured operating devices briefly. During initialisation, " - " is displayed on the 7-segment display on the front panel of the device.
- i** The "Activate staircase function" setting is only available when the staircase function is enabled for the affected group or the affected single device.
- i** Setting "Brightness before bus/mains voltage failure": An ETS programming operation of the application or the parameter resets the internally stored brightness state to "OFF".
- i** In the "No reaction" setting: The communication objects of the gateway are initialised with "0" after bus/mains voltage return. In this case, the switching status or brightness value feedback only corresponds to the 'true' brightness state when the group or the single device have been controlled at least once via the KNX or by manual operation.
- i** If mains voltage only on the connected DALI operating devices (e.g. supply from an external mains conductor) is switched on or the gateway is also switched on again and the response is configured to "no reaction", the operating devices set themselves to the brightness specified in their "Power-On level". After an ETS programming operation, this value is programmed into the operating devices by the gateway and corresponds to the setting of the parameter "After bus /mains voltage return". In the settings "Brightness before bus/mains voltage failure" and "Activate staircase function", the command "no reaction" is programmed as a power-on level into the operating devices. In the case of all other settings, the configured commands are applied directly in the operating devices. If the mains voltage of the gateway is switched on, the device executes the parameter "After bus/mains voltage return" only after initialisation. It may occur that the DALI operating devices react more quickly after bus voltage return and set themselves to the power-on level before the gateway can transmit individual commands on the DALI line. This may result in short brightness jumps. If KNX telegrams for groups or single devices are received during the initialisation of the gateway, the device will perform the most recently specified command and not the configured behaviour after the bus voltage returns.
- i** When using standby switch-off and the delay until start-up of the DALI devices, ensure that the parameter "After bus/main voltage return" is configured as "Switch off". This means that the affected devices do not switch-on directly when the mains voltage returns but only after they have received an appropriate DALI command from the gateway via the DALI cable.

- i** In the case of forced position as supplementary function: The communication object of the forced position can be initialised separately after bus voltage return. This has an effect on the reaction of the group or single device if the forced position is activated when the bus voltage returns. The configured behaviour "after bus/mains voltage return" will only be executed if no forced position on bus voltage return is activated.
- i** With disabling function as supplementary function: Active disabling functions are always inactive after bus or mains voltage return.
- i** Manual operation is possible only when the mains voltage supply to the gateway is switched on. Manual operation ends in case of bus voltage failure, bus voltage return or mains voltage failure.

Presetting the behaviour of the brightness after an ETS programming operation

The parameter "After ETS programming operation" is available separately for each group and each single device in the parameter node "DALI system... -> Configuration groups -> [x] Group name" or "DALI system... -> Configuration single devices -> [x] Device name".

- Set the parameter to "no reaction".

After an ETS programming operation, the gateway does not transmit any commands to the DALI operating devices. The assigned DALI operating devices show no response and remain in the brightness state that was last set.
- i** In this state, no colour temperature control or colour control is possible after an ETS programming operation of the operating devices concerned even if the devices are still switched on due to the last brightness state. In this case, the group or single device concerned must either be switched off and switched on again after the ETS programming operation or must be preset to a brightness value unequal "0 %" by a new telegram. Only in this way does the gateway evaluate the state "ON" for the operating devices and permits a control of the colour temperature or colour by new commands.
- Set the parameter to "Switch off".

The DALI operating devices are switched off by the ETS after an ETS programming operation.
- Set the parameter to "Brightness value". Configure the required value in the following parameter "Brightness value".

The DALI operating devices are set to the predefined brightness value via the DALI cable. The selection of the configurable value is not limited at the limits by the specified minimum and maximum brightness. If brightness values lower than the minimum brightness or higher than the maximum brightness are set, the gateway sets the brightness to the configured minimum and maximum limit values.
- Set the parameter to "as for bus/mains voltage return".

In this setting, the gateway shows the same behaviour after an ETS programming operation as with a bus or mains voltage return. The behaviour is specified by the parameter "After bus/mains voltage return".

- i** The configured behaviour will be executed after every application or parameter download by the ETS. A simple download of the physical address alone or partial programming of only the group addresses has the effect that this parameter is disregarded and that the configured "Behaviour after bus voltage return" will be executed instead.
- i** An ETS programming operation can only be executed if the mains voltage supply of the DALI gateway is switched on.
- i** In the "no reaction" setting: The communication objects of the gateway are initialised with "0" after a programming operation. In this case, the switching status or brightness value feedback only corresponds to the 'true' brightness state when the group or the single device have been controlled at least once via the KNX or by manual operation. In this setting, feedback objects set as actively transmitting do not transmit a telegram.
- i** After an ETS programming operation, the disabling functions and the forced-positions are always deactivated.
- i** After an ETS programming operation, the gateway initialises itself and configures the connected operating devices with relevant data via the DALI cable (e.g. minimum brightness, maximum brightness, power-on level, system failure level). For this reason, the entire DALI system should ideally be connected and completely ready for operation so that all operating devices apply configuration changes. After each DALI commissioning with changes (fully or partially), the application program must be reloaded into the gateway using the ETS. When doing so, it must be ensured that at least the newly added operating devices or devices, in which the configuration was changed in the ETS, are ready for operation after the ETS programming operation during the commissioning! If there is an error on the DALI cable (e.g. short-circuit, cable break) during the initialisation of the operating devices, then the DALI configuration cannot be executed. The error must then be eliminated and ETS programming restarted. During the configuration operation after an ETS programming operation, "- -" is displayed in the 7-segment display on the front panel of the device.
- i** If KNX telegrams for groups or single devices are received during the initialisation of the gateway, the device will perform the most recently specified command and not the configured behaviour after an ETS programming operation.

Behaviour of the colour temperature in case of bus voltage failure

The behaviour of the colour temperature in case of bus voltage failure, just like the behaviour after an ETS programming operation, is permanently preset to "no change". In the case of a bus voltage failure, the gateway does not transmit any colour temperature commands to the DALI operating devices. The assigned DALI oper-

ating devices remain at the colour temperature most recently set provided that the mains voltage supply of the operating devices is still guaranteed. After bus voltage failure, it is no longer possible to control the colour temperature.

- i** DALI operating devices that support the device type "Tunable White" (DT8 - TW) are able to store a specific value during the commissioning, which defines the effective colour change for the failure of the DALI operating voltage for selectively influencing the colour temperature control. The gateway always initialises this DALI parameter in the operating devices during the configuration of the "System Failure Level" for the brightness with the command "no change" (value "255" / "MASK"), so that a failure of the DALI operating voltage (e.g. due to a failure of the mains voltage supply on the gateway) does not cause a change in the colour temperature value most recently specified.

Behaviour of the colour temperature after bus voltage return

The behaviour of the colour temperature after bus or mains voltage return is preset permanently to "Colour temperature before bus voltage failure". After the bus or mains voltage returns, the colour temperature set most recently before the bus/mains voltage failure by relative or absolute dimming and stored internally in the event of a bus/mains voltage failure is tracked.

- i** The gateway transmits the tracked colour temperature to the operating devices only in the state "ON". Consequently, after bus or mains voltage return a tracked or new colour temperature is only then preset in the operating devices via the colour temperature predefined via the KNX after the group or single device was switched on to a brightness value unequal "0 %".
- i** An ETS programming operation of the application or the parameter resets the internally stored colour temperature (0 K). This means that the operating devices concerned normally set themselves to minimum or maximum colour temperature as soon as the group or single device is switched on after bus or mains voltage return (e.g. by the configured behaviour of the brightness after bus voltage return). In this case, the behaviour of the operating devices with regard to the colour temperature is defined immediately by the operating devices and cannot be influenced by the gateway. The colour temperature is only then valid after an ETS programming operation as soon as a colour temperature value is newly specified as a result of relative or absolute dimming. The colour temperature only becomes invalid after an ETS programming operation by recalling a scene with a defined colour temperature value.
- i** The communication objects of the gateway are initialised with "0" after bus/ mains voltage return. After bus voltage return, actively transmitting feedback objects transmit a telegram corresponding to the most recently effective colour temperature in the gateway, but only if the DALI group or single device is also switched on after mains voltage return (brightness unequal "0 %"). After a mains voltage return, only telegrams corresponding to the effective colour temperature in the gateway are transmitted when the DALI group or single device is actively on after mains voltage return (brightness unequal "0 %").

Behaviour of the colour temperature after an ETS programming operation

The behaviour of the colour temperature after an ETS programming operation is permanently set to "no change". After an ETS programming operation, the gateway does not transmit any colour temperatures to the DALI operating devices. This means that the assigned DALI operating devices remain in the colour temperature most recently specified.

- i** The gateway only transmits new colour temperatures in the state "ON" to the operating devices. Consequently, after an ETS programming operation, a new colour temperature specified via the KNX is only set in the operating devices after the group or the single device has been switched on to a brightness value not equal to "0 %".
- i** The communication objects of the gateway are initialised with "0" after a programming operation. In this case, the feedback of the colour temperature only then corresponds to a valid value when the colour temperature of the group or single device was controlled at least once via the KNX and the transmission criterion of the feedback was met. Actively transmitting feedback objects of the colour temperature automatically do not transmit any telegram immediately after an ETS programming operation.
- i** The predefined behaviour is executed by the ETS after every application or parameter download. The simple download of the physical address alone or partial programming of only the group addresses has the effect that the setting "no change" is disregarded and that the specified "Behaviour of the colour temperature after bus voltage return" will be executed instead.
- i** If KNX telegrams for groups or single devices are received for controlling the colour temperature after an ETS programming operation during the initialisation of the gateway (indication "- -" on the 7-segment display on the front panel of the device), the device will perform the most recently specified command.
- i** DALI operating devices normally only store the most recently specified colour temperature in the volatile memory. This means that the most recently transmitted colour temperature information will be lost due to a failure of the mains voltage on the operating devices. After mains voltage return, operating devices normally set themselves to minimum or maximum colour temperature provided that the brightness of the group or single device was predefined greater than "0 %" (power-on level). The behaviour on the operating devices with regard to the colour temperature after mains voltage return is defined immediately by the operating devices and cannot be influenced or signalled back by the gateway. The gateway can only influence the colour temperature after mains voltage return if the mains voltage was also switched off and switched on again on the gateway (see "Behaviour of the colour temperature after bus voltage return").

Behaviour of the colour in the event of a bus voltage failure

The behaviour of the colour in case of bus voltage failure, just like the behaviour after an ETS programming operation, is permanently preset to "no change". In the case of a bus voltage failure, the gateway does not transmit any commands to the DALI operating devices. The assigned DALI operating devices remain at the colour value most recently set provided that the mains voltage supply of the operating devices is still guaranteed. After bus voltage failure, it is no longer possible to control the colour.

- i** DALI operating devices that support the device type "Colour Control" (DT8 - RGBW) are able to store a specific value during the commissioning, which defines the effective colour for the failure of the DALI operating voltage for selectively influencing the colour control. The gateway always initialises this DALI parameter in the operating devices during the configuration of the "System Failure Level" for the brightness with the command "no change" (value "255" / "MASK"), so that a failure of the DALI operating voltage (e.g. due to a failure of the mains voltage supply on the gateway) does not cause a change in the colour value most recently specified.

Behaviour of colour after bus voltage return

The behaviour of the colour after bus or mains voltage return is preset permanently to "Colour before bus voltage failure". After the bus or mains voltage returns, the colour set most recently before the bus/mains voltage failure by relative or absolute dimming and stored internally in the event of a bus/mains voltage failure is tracked.

- i** The gateway transmits the tracked colour to the operating devices only in the state "ON". Consequently, after bus or mains voltage return a tracked or new colour temperature is only then preset in the operating devices via the colour predefined via the KNX after the group or single device was switched on to a brightness value unequal "0 %".
- i** An ETS programming operation of the application or the parameter resets the internally stored colour (#000000). In this case, the behaviour of the operating devices after the mains voltage returns with regard to the colour temperature is defined immediately by the operating devices and cannot be influenced by the gateway. The colour is only then valid after an ETS programming operation as soon as a colour value is newly specified as a result of relative or absolute dimming. The colour does not become valid after an ETS programming operation only by recalling a scene with a defined colour value.
- i** The communication objects of the gateway are initialised with "0" after bus/mains voltage return. After bus voltage return, actively transmitting feedback objects transmit a telegram corresponding to the most recently effective colour in the gateway, but only if the DALI group or single device is also switched on after mains voltage return (brightness unequal "0 %"). After a mains voltage return, only telegrams corresponding to the effective colour in the gateway are transmitted when the DALI group or single device is actively on after mains voltage return (brightness unequal "0 %").

Behaviour of the colour after ETS programming

The behaviour of the colour after an ETS programming operation is permanently set to "no change". After an ETS programming operation, the gateway does not transmit any colours to the DALI operating devices. This means that the assigned DALI operating devices remain in the colour most recently specified.

- i** The gateway transmits new colours only in the state "ON" to the operating devices. Consequently, after an ETS programming operation, a new colour specified via the KNX is set in the operating devices only after the group or single device has been switched on to a brightness value not equal to "0%".
- i** The communication objects of the gateway are initialised with "0" after a programming operation. In this case, the feedback of the colour only then corresponds to a valid value when the colour of the group or single device was controlled at least once via the KNX and the transmission criterion of the feedback was met. Actively transmitting feedback objects of the colour automatically do not transmit any telegram immediately after an ETS programming operation.
- i** The predefined behaviour is executed by the ETS after every application or parameter download. The simple download of the physical address alone or partial programming of only the group addresses has the effect that the setting "no change" is disregarded and that the specified "Behaviour of the colour after bus voltage return" will be executed instead.
- i** If KNX telegrams for groups or single devices are received for controlling the colour after an ETS programming operation during the initialisation of the gateway (indication "- -" on the 7-segment display on the front panel of the device), the device will perform the most recently specified command.
- i** DALI operating devices normally only store the most recently specified colour in the volatile memory. This means that the most recently transmitted colour information will be lost due to a failure of the mains voltage on the operating devices. After mains voltage return, operating devices normally set themselves to an internally initialized colour provided that the brightness of the group or single device was predefined greater than "0%" (power-on level). The behaviour on the operating devices with regard to the colour after mains voltage return is defined immediately by the operating devices and cannot be influenced or signalled back by the gateway. The gateway can influence the colour temperature only after mains voltage return if the mains voltage was also switched off and switched on again at the gateway (see "Behaviour of the colour after bus voltage return").

9.4.1 Parameters for device reset

DALI system... -> Configuration groups -> [x] Group name

DALI system... -> Configuration of single devices -> [x] Device name

after ETS programming operation	Brightness value Switch off no reaction As for bus/mains voltage return
<p>The configured behaviour will be executed after every application or parameter download by the ETS. A simple download of the physical address alone or partial programming of only the group addresses has the effect that this parameter is disregarded and that the configured "Behaviour after bus voltage return" will be executed instead.</p> <p>Brightness value: The DALI operating devices are set to the value specified by the "Brightness value" parameter via the DALI line after an ETS programming operation.</p> <p>Switch off: The DALI operating devices are switched off by the ETS after an ETS programming operation.</p> <p>No reaction: After an ETS programming operation, the gateway does not transmit any commands to the DALI operating devices. The assigned DALI operating devices show no response and remain in the brightness state that was last set. In this state, no colour temperature control or colour control is possible after an ETS programming operation of the operating devices concerned even if the devices are still switched on due to the last brightness state. In this case, the group or single device concerned must either be switched off and switched on again after the ETS programming operation or must be preset to a brightness value unequal "0 %" by a new telegram. Only in this way does the gateway evaluate the state "ON" for the operating devices and permits a control of the colour temperature or colour by new commands.</p> <p>As with bus/mains voltage return: In this setting, the gateway shows the same behaviour after an ETS programming operation as with a bus or mains voltage return. The behaviour is specified by the parameter "After bus/mains voltage return".</p>	
Brightness value	1%, 2%, 3%, 4%, 5%, 6%, 7%, 8%, 9%, 10%, 15%, 20%...50%... 100%
<p>At this point, the brightness value to be set after an ETS programming operation is specified.</p> <p>The selection of the configurable value is not limited at the limits by the specified minimum and maximum brightness. If brightness values lower than the minimum brightness or higher than the maximum brightness are set, the gateway sets the brightness to the configured minimum and maximum limit values.</p> <p>This parameter is available only with "After ETS programming operation = brightness value".</p>	

at bus/mains voltage failure	Brightness value Switch off no reaction
<p>The behaviour parameterised at this point is executed in the event of a bus or mains voltage failure (mains voltage of the gateway). If there is a voltage failure on the DALI cable (e.g. due to short-circuit, cable break, mains voltage failure on gateway), then the assigned DALI operating devices will also show the configured behaviour in the event of a bus voltage failure. This is guaranteed because the parameter setting in the DALI operating devices is applied as the "System Failure Level" for the brightness after an ETS programming operation.</p> <p>Brightness value: The DALI operating devices are set to the value specified by the "Brightness value" parameter via the DALI line in the event of a bus voltage failure at the gateway, provided the mains voltage supply of the gateway is still switched on. If the mains voltage fails at the gateway, this command can no longer be issued. In this case, the DALI operating devices set themselves to the programmed system failure level corresponding to this parameter, provided their mains voltage supply is still switched on.</p> <p>Switch off: The DALI operating devices are switched off via the DALI cable in the case of a bus voltage failure if the mains voltage supply of the gateway is still switched on. If the mains voltage fails at the gateway, this command can no longer be issued. Here, too, the DALI operating devices set themselves to the programmed system failure level that corresponds to this parameter, provided their mains voltage supply is still switched on.</p> <p>No reaction: The gateway does not send any commands to the DALI operating devices in the event of a bus or mains voltage failure. The assigned DALI operating devices, provided their mains voltage supply is still switched on, show no response and remain in the brightness state that was last set.</p>	
Brightness value	1%, 2%, 3%, 4%, 5%, 6%, 7%, 8%, 9%, 10%, 15%, 20%...50%... 100%
<p>At this point, the brightness value to be set in the event of a bus or mains voltage failure is specified.</p> <p>The selection of the configurable value is not limited at the limits by the specified minimum and maximum brightness. If brightness values lower than the minimum brightness or higher than the maximum brightness are set, the gateway sets the brightness to the configured minimum and maximum limit values.</p> <p>This parameter is available only with "at bus/mains voltage failure = brightness value".</p>	

after bus/mains voltage return	Brightness value Switch off brightness before bus/mains voltage failure no reaction activating staircase function
<p>The behaviour configured at this point is executed after the bus or mains voltage returns (mains voltage of the gateway). If mains voltage only on the connected DALI operating devices (e.g. supply from an external mains conductor) is switched on or the gateway is also switched on again and the response is configured to "no reaction", the operating devices set themselves to the brightness specified in their "Power-On level". After an ETS programming operation, this value is programmed into the operating devices by the gateway and corresponds to the setting of this parameter. In the settings "Brightness before bus/mains voltage failure" and "Activate staircase function", the command "no reaction" is programmed as a power-on level into the operating devices. In the case of all other settings, the configured commands are applied directly in the operating devices. If the mains voltage of the gateway is switched on, the device executes the parameter only after initialisation. It may occur that the DALI operating devices react more quickly after bus voltage return and set themselves to the power-on level before the gateway can transmit individual commands on the DALI line. This may result in short brightness jumps. If KNX telegrams for groups or single devices are received during the initialisation of the gateway, the device will perform the most recently specified command and not the configured behaviour after the bus voltage returns.</p> <p>When using standby switch-off and the delay until start-up of the DALI devices, ensure that this parameter is configured to "Switch off". This means that the affected devices do not switch on directly when the mains voltage returns but only after they have received an appropriate DALI command from the gateway via the DALI cable.</p> <p>Brightness value: The DALI operating devices are set to the value specified by the "Brightness value" parameter over the DALI line after the bus or mains voltage returns at the gateway.</p> <p>Switch-off: The DALI operating devices are switched off when the bus/mains voltage returns via the DALI line.</p> <p>Brightness before bus/mains voltage failure: After the bus or mains voltage returns, the brightness value set most recently before the bus or mains voltage failure and saved internally on bus/mains voltage failure is tracked. An ETS programming operation of the application or the parameter resets the internally stored brightness state to "OFF".</p>	

after bus/mains voltage return	Brightness value Switch off brightness before bus/mains voltage failure no reaction activating staircase function
--------------------------------	--

No reaction: After the bus or mains voltage returns, the gateway does not transmit any commands to the DALI operating devices. The assigned operating devices do not respond and remain in the brightness state that was last set. In this state, no colour temperature control or colour control is possible after bus or mains voltage return even if the devices are still switched on due to the last brightness state. In this case, the group or single device concerned must either be switched off and switched on again after bus or mains voltage return or must be preset to a brightness value unequal "0 %" by a new telegram. Only in this way does the gateway evaluate the state "ON" for the operating devices and permits a control of the colour temperature or colour by new commands.

Activate staircase function: The staircase function is activated - independently of the object "Staircase function - Start/Stop" - after the bus or mains voltage returns. This setting is available only when the staircase function is enabled for the affected group or single device.

Brightness value	1%, 2%, 3%, 4%, 5%, 6%, 7%, 8%, 9%, 10%, 15%, 20%...50%...100%
------------------	--

At this point, the brightness value to be set after the bus or mains voltage returns is specified.

The selection of the configurable value is not limited at the limits by the specified minimum and maximum brightness. If brightness values lower than the minimum brightness or higher than the maximum brightness are set, the gateway sets the brightness to the configured minimum and maximum limit values.

This parameter is available only with "After bus/mains voltage return = brightness value".

DALI system... -> Configuration groups -> [x] Group name -> Colour temperature

DALI system... -> Configuration single devices -> [x] Device name -> Colour temperature

Behaviour of the colour temperature after an ETS programming operation	No change
--	------------------

The behaviour of the colour temperature after an ETS programming operation is permanently set to "no change". After an ETS programming operation, the gateway does not transmit any colour temperatures to the DALI operating devices. This means that the assigned DALI operating devices remain in the colour temperature most recently specified.

Behaviour of the colour temperature in case of bus voltage failure	No change
<p>The behaviour of the colour temperature in case of bus voltage failure, just like the behaviour after an ETS programming operation, is permanently preset to "no change". In the case of a bus voltage failure, the gateway does not transmit any commands to the DALI operating devices. The assigned DALI operating devices remain at the colour temperature most recently set provided that the mains voltage supply of the operating devices is still guaranteed. After bus voltage failure, it is no longer possible to control the colour temperature.</p>	

Behaviour of the colour temperature when the bus voltage returns	Colour temperature before bus mains voltage failure
<p>The behaviour of the colour temperature after the bus or mains voltage returns is set permanently to "Colour temperature before bus/mains voltage failure". After the bus or mains voltage returns, the colour temperature set most recently before the bus/ mains voltage failure by relative or absolute dimming and stored internally in the event of a bus/mains voltage failure is tracked.</p>	

DALI system... -> Configuration groups -> [x] Group name -> Colour

DALI system... -> Configuration single devices -> [x] Device name -> Colour

Behaviour of the colour after ETS programming	No change
<p>The behaviour of the colour after an ETS programming operation is permanently set to "no change". After an ETS programming operation, the gateway does not transmit any colours to the DALI operating devices. This means that the assigned DALI operating devices remain in the colour most recently specified.</p>	

Behaviour of the colour in the event of a bus voltage failure	No change
<p>The behaviour of the colour in case of bus voltage failure, just like the behaviour after an ETS programming operation, is permanently preset to "no change". In the case of a bus voltage failure, the gateway does not transmit any commands to the DALI operating devices. The assigned DALI operating devices remain in the colour most recently set, provided that the mains voltage supply of the operating devices is still guaranteed. After bus voltage failure, it is no longer possible to control the colour.</p>	

Behaviour of the colour when the bus voltage returns	Colour before bus/mains voltage failure
<p>The behaviour of the colour after the bus or mains voltage returns is set permanently to "Colour before bus/mains voltage failure". After the bus or mains voltage returns, the colour set most recently before the bus/mains voltage failure by relative or absolute dimming and stored internally in the event of a bus/mains voltage failure is tracked.</p>	

9.5 Supplementary functions

Supplementary functions

Supplementary functions can be enabled for each group and single device. As a supplementary function, a disabling or alternatively a forced position function can be configured. In this respect, only one of these functions can be enabled for each group or single device.

The supplementary functions are enabled on the parameter pages "DALI system... -> Configuration groups -> [x] Group name -> Enabled functions" or "DALI system... -> Configuration single devices -> [x] Device name -> Enabled functions". When activated, further parameter pages become visible on which the functions can be configured.

9.5.1 Disabling function

During an active disabling function, the KNX operation of the groups or single devices is overridden and locked. Continuous light switching, for example, can also be overridden. The disabling function can be optionally revoked with an additional 1-bit acknowledgement object. This prevents the deactivation of the disabling function by the disabling object.

- On the parameter page "DALI system... -> Configuration groups -> [x] Group name -> Enabled functions" or "DALI system... -> Configuration single devices -> [x] Device name -> Enabled functions", set the parameter "Disabling function / Forced position" to "Disabling function".

The disabling function is enabled. The communication object "Disabling function - Activate/ Deactivate" and the parameters of the disabling function become visible.

The parameters for configuring the disabling function are available on the parameter page "DALI system... -> Configuration groups -> [x] Group name -> Disabling function" or "DALI system... -> Configuration single devices -> [x] Device name -> Disabling function".

The behaviour at the beginning of the disabling function can be specified separately for the brightness control and optionally - if the groups and single devices have this range of functions - also for the colour temperature control and colour control.

- Configure the "Object polarity" parameter to the desired polarity for activating and deactivating the disabling function.
- Set the parameter "At beginning of brightness" to the required behaviour.

At the beginning of the disabling function, the configured behaviour will be executed and the bus control of the group or single device locked.

Switch-off: A group or single device switches off at the beginning of the disabling function.

Preset: The brightness specified by the "Brightness value" parameter is set at the beginning of the disabling function.

Memory value (brightness before last switch-off): The brightness value is set that was active before the last switch-off and stored internally in the device. This memory value is stored in a non-volatile manner in the gateway so that the value is retained after the bus or mains voltage returns. After an ETS programming operation, the memory value is predefined to "100%". This value is optionally limited by the maximum brightness.

No reaction: The operating devices of the disabled group or the single device do not react. The devices remain in the most recently set brightness state.

Flashing: The affected devices are switched on and off cyclically during disabling. The "Time for flashing of the disabling functions" is generally configured on the parameter page "DALI System... -> General". During flashing, the logical switching state is fed back as "Switched on" and the brightness value as "Switch-on brightness". A soft ON/OFF function is not executed during flashing.

- Set the parameter "At beginning of colour temperature" to the required behaviour.

At the beginning of the disabling function, the configured behaviour will be executed and the bus control of the group or single device locked.

Preset: The colour temperature specified by the "Colour temperature" parameter is set at the beginning of the disabling function.

Memory value (colour temperature before last switch-off): The colour temperature value is set that was active before the last switch-off and stored internally in the device. This memory value is stored in a non-volatile manner in the gateway so that the value is retained after the bus or mains voltage returns. After ETS programming, the memory value is predefined to "minimum colour temperature".

No reaction: The operating devices of the disabled group or the single device do not react. The devices remain in the colour temperature state last set.

- Set the parameter "At beginning of colour" to the required behaviour.

At the beginning of the disabling function, the configured behaviour will be executed and the bus control of the group or single device locked.

Preset: The colour specified by the parameter "Colour (RGB)" and optionally "White value (W)" is set at the beginning of the disabling function.

Memory value (colour before last switch-off): The colour is set that was active before the last switch-off and stored internally in the device. This memory value is stored in a non-volatile manner in the gateway so that the value is retained after the bus or mains voltage returns. After an ETS programming operation, the memory colour value is predefined at "#FFFFFF" and the optional white value at "#FF".

No reaction: The operating devices of the disabled group or the single device do not react. The devices remain in the colour state last set.

The behaviour at the end of the disabling function can also be specified separately for the brightness control and optionally also for the colour temperature control and colour control. The behaviour is influenced by the acknowledgement object.

For disabling function without acknowledgement object...

- Deactivate the parameter "Confirmation".

No additional acknowledgement object is available. The disabling function is deactivated by the disabling object according to the set polarity.

For disabling function with acknowledgement object...

- Activate the parameter "Acknowledgement".

The acknowledgement object is available. The disabling function can only be deactivated using the acknowledgement object by an "ON telegram". Telegrams to the disabling object according to the "Deactivate disabling" polarity are ignored by the gateway.

i OFF telegrams to the acknowledgement object do not product a reaction.

- Set the parameter "At the end... brightness" to the required behaviour.

At the end of the disabling function, the configured behaviour will be executed and the bus control of the group or the single device enabled again.

Switch-off: A group or single device switches off at the end of the disabling function.

Track: The set state received during the disabling function or adjusted before the disabling function can be tracked at the end of the disabling with the appropriate brightness value.

Preset: The brightness specified by the "Brightness value" parameter is set at the end of the disabling function.

Memory value (brightness before last switch-off). The brightness value is set that was active before the last switch-off and stored internally in the device. This memory value is stored in a non-volatile manner in the gateway so that the value is retained after the bus or mains voltage returns. After an ETS programming operation, the memory value is predefined to "100%". This value is optionally limited by the maximum brightness.

No reaction: The operating devices of the disabled group or the single device do not react. The devices remain in the state most recently set by the disabling function.

Flashing: The affected devices are switched on and off cyclically after disabling. The flashing time is generally configured on the parameter page "DALI System... -> General". During flashing, the logical switching state is fed back as "Switched on" and the brightness value as "Switch-on brightness". A soft

ON/OFF function is not executed during flashing. The flashing status remains active until another bus command is received or manual operation specifies another brightness value.

- Set the parameter "At the end... colour temperature" to the required behaviour. At the beginning of the disabling function, the configured behaviour will be executed and the bus control of the group or single device locked.

Track: The set state received during the disabling function or adjusted before the disabling function can be tracked at the end of the disabling with the appropriate colour temperature value.

Preset: The colour temperature specified by the "Colour temperature" parameter is set at the beginning of the disabling function.

Memory value (colour temperature before last switch-off): The colour temperature value is set that was active before the last switch-off and stored internally in the device. This memory value is stored in a non-volatile manner in the gateway so that the value is retained after the bus or mains voltage returns. After ETS programming, the memory value is predefined to "minimum colour temperature".

No reaction: The operating devices of the disabled group or the single device do not react. The devices remain in the colour temperature state last set.

- Set the parameter "At the end... colour" to the required behaviour. At the beginning of the disabling function, the configured behaviour will be executed and the bus control of the group or single device locked.

Track: The set state received during the disabling function or adjusted before the disabling function can be tracked at the end of the disabling with the appropriate colour value.

Preset: The colour specified by the parameter "Colour (RGB)" and optionally "White value (W)" is set at the beginning of the disabling function.

Memory value (colour before last switch-off): The colour is set that was active before the last switch-off and stored internally in the device. This memory value is stored in a non-volatile manner in the gateway so that the value is retained after the bus or mains voltage returns. After an ETS programming operation, the memory colour value is predefined at "#FFFFFF" and the optional white value at "#FF".

No reaction: The operating devices of the disabled group or the single device do not react. The devices remain in the colour state last set.

- i** In the "track" setting: During disabling, the overridden functions of the gateway (switching, dimming, value specifications) continue to be processed internally in the device. Consequently, newly received KNX telegrams are evaluated and time functions are triggered as well. At the end of the disabling, the tracked states are set. A scene recall (low priority) is not tracked.

- i** After a bus failure or mains voltage failure or programming the application or the parameters with the ETS, the disabling function is always deactivated (object value "0"). With the inverted setting ("1 = enabled / 0 = disabled"), a telegram update "0" must first be carried out after the initialisation until the disabling is activated.
- i** When tracking blocking functions at the end of a manual operation: If a disabling function was activated via the KNX before or during temporary or permanent manual operation, the gateway always executes this higher-priority function for the affected groups and single devices at the end of the manual operation (disabling of bus operation). Only in the setting "At end of permanent manual operation = Track outputs" does the gateway perform the behaviour at the beginning of the disabling function again. Bus operation by switching, dimming, value, scene, central is then disabled.
- i** Updates of the disabling object from "activated" to "deactivated" do not produce a reaction. Exception: If the behaviour is set to "no change" at the end of a manual operation, the gateway subsequently performs active disabling functions (locking of bus operation). If a "Disabling function activated" telegram is received again in this state, the gateway carries out the behaviour at the beginning of the disabling function again.

9.5.2 Forced position

The forced position function can also be combined with other functions of a group or single device. With an active forced position, the upstream functions are overridden so that the affected group or device is locked. The forced position function possesses a separate 2-bit communication object. The first bit (bit 0) of the object "Forced position - Activate/Deactivate" indicates whether switch-off or switch-on is forced. If the dimming channel is switched on by force, an ETS parameter defines which brightness value it should be switched on to. The second bit (bit 1) of the object activates or deactivates the restraint. The behaviour at the end of the forced position function can be configured. In addition, the forced object can be initialised after bus or mains voltage return.

Bit 1	Bit 0	Function
0	X	Forced position not active -> normal control
0	X	Forced position not active -> normal control
1	0	Forced position active: switch off
1	1	Forced position active: switch on to predefined brightness value

Figure 46: Bit coding of forced position

- On the parameter page "DALI system... -> Configuration groups -> [x] Group name -> Enabled functions" or "DALI system... -> Configuration Single Devices -> [x] Device Name -> Enables", set the parameter "Disabling function / Forced position" to "Forced position".

The forced position is enabled. The communication object "Forced position - Activate/Deactivate" and the parameter of the forced position function become visible.

The parameters for configuring the forced position are available on the parameter page "DALI system... -> Configuration groups -> [x] Group name -> Forced Position" or "DALI system... -> Configuration single devices -> [x] Device name -> Forced position".

A forced position influences only the brightness control of a group or single device. The colour temperature or colour - provided that the groups and single devices have this range of functions - always remains unchanged in a forced position.

i With colour-controllable DALI operating devices, the colour is set to the maximum colour value (RGB: #FFFFFF) and, if necessary, additionally to the maximum white value (#FF) in the event of a forced position, but only if the current colour corresponds to the state "#000000" (black) and the optional white value corresponds to "#00". This ensures that manual brightness control via the forced position is recognisable to the user.

- Configure the parameter "forced position 'active, switch-on'" to the required behaviour that should be executed if a forced control is activated via the communication object.

Preset: The DALI operating devices set themselves to the brightness configured in the "Brightness value" parameter in the event of a restraint.

No reaction: The bus operation is locked but the operating devices show no response and remain in the most recently set brightness state.

Memory value (brightness before last switch-off): The brightness value is set that was active before the last switch-off and stored internally in the device. This memory value is stored in a non-volatile manner in the gateway so that the value is retained after the bus or mains voltage returns. After an ETS programming operation, the memory value is predefined to "100%". This value is optionally limited by the maximum brightness.

- Set the parameter "forced position end 'inactive'" to the required behaviour. At the end of the forced position, the configured behaviour will be executed. Bus operation is enabled again.

Track: The state received during the forced position function or the brightness value adjusted before the function can be tracked at the end of the forced position. Any time functions still in progress will also be taken into account if necessary. A scene recall (low priority) is not tracked.

No reaction: The operating devices show no response and remain in the brightness state last selected by the forced position.

i When tracking forced positions at the end of a manual operation: If a forced position was activated via the KNX before or during a temporary or permanent manual operation, the gateway always executes this higher-priority function for the affected groups and single devices at the end of the manual operation

(locking of bus operation). Only in the setting "At end of permanent manual operation = Track outputs" does the gateway carry out the behaviour at the beginning of the forced position again. Bus operation by switching, dimming, value, scene, central is then disabled.

- i** Updates of the forced position object (e. g. "forced position active" to "forced position active" while maintaining the switching status or from "forced position inactive" to "forced position inactive") show no reaction. Exception: If the behaviour is set to "no change" at the end of a manual operation, the gateway tracks active forced positions (locking of bus operation). If a "Forced position active" telegram is received again in this state, the gateway executes the behaviour at the beginning of the forced position again.
- i** The current state of the object of the forced position function will be stored in case of bus or mains voltage failure.
 - Set the parameter "After bus/mains voltage return" to the required behaviour. After bus or mains voltage return, the configured state is transferred to the "Forced position - Activate/Deactivate" communication object. When a forced position is activated, the group or the single device is immediately activated and interlocked accordingly by forced control after bus/mains voltage return until a forced control takes place via the KNX. In this case, the parameter "After bus voltage return" is not evaluated.

State before bus/mains voltage failure: The last existing and internally stored state of the forced position before bus or mains voltage failure will be tracked. An ETS programming operation deletes the stored state (reaction in that case same as with "no forced position active"). If the tracked state corresponds to "No forced position active", the force-independent parameter "After bus voltage return" will be executed on return of bus voltage. If forced position is activated, the DALI operating devices are switched on to the brightness value predefined by the parameter "Forced position 'active, switch-on'".

- i** After programming the application or parameters with the ETS, the forced position function is always deactivated (object value "0").

9.5.3 Parameter for supplementary functions

DALI system... -> Configuration groups -> [x] Group name -> Enabled functions

DALI system... -> Configuration single devices -> [x] Device name -> Enabled functions

Disabling function / Forced position	no selection Disabling function forced position
<p>Supplementary functions can be enabled for each group and single device. As a supplementary function, a disabling or alternatively a forced position function can be configured. In this respect, only one of these functions can be enabled for each group or single device.</p> <p>Disabling function: During an active disabling function, the KNX operation of the groups or single devices is overridden and locked. Continuous light switching, for example, can also be overridden. The deactivation of the disabling function can optionally take place using an additional 1-bit acknowledgement object. This prevents the deactivation of the disabling function by the disabling object. The disabling function is enabled. The communication object "Disabling function - Activate/ Deactivate" and the parameters of the disabling function become visible.</p> <p>Forced position: The forced position function can also be combined with other functions of a group or single device. With an active forced position, the upstream functions are overridden so that the affected group or device is locked. The forced position function possesses a separate 2-bit communication object. The forced position is enabled. The communication object "Forced position - Activate/Deactivate" and the parameter of the forced position function become visible.</p>	

With disabling function as supplementary function:

DALI system... -> General

Time for flashing the disabling functions	1 s 2 s 5 s 10 s
<p>At the beginning and end of a disabling function, assigned groups and single devices can flash (cyclical switching on and off). The flashing time is configured globally for all disabling functions of the DALI system at this point.</p>	

DALI system... -> Configuration groups -> [x] Group name -> Disabling function

DALI system... -> Configuration single devices -> [x] Device name -> Disabling function

Acknowledgement	Checkbox (yes/no)
<p>The acknowledgment prevents the deactivation of the disabling function by the disabling object. The behaviour at the end of the disabling function is influenced by the acknowledgement object.</p> <p>Checkbox activated: The acknowledgement object is available. The disabling function can only be deactivated using the acknowledgement object by an "ON telegram". Telegrams to the disabling object according to the "Deactivate disabling" polarity are ignored by the gateway.</p> <p>Checkbox deactivated: No additional acknowledgement object is available. The disabling function is deactivated by the disabling object according to the set polarity.</p>	
Object polarity	0 = enabled / 1 = disabled 1 = enabled / 0 = disabled
<p>This parameter configures the desired polarity for activating and deactivating the disabling function.</p> <p>After a bus failure or mains voltage failure or programming the application or the parameters with the ETS, the disabling function is always deactivated (object value "0"). With the inverted setting ("1 = enabled / 0 = disabled"), a telegram update "0" must first be carried out after the initialisation until the disabling is activated.</p>	

<p>At start... Brightness</p>	<p>Switch off preset Memory value (brightness like before the last switch-off) no reaction flashing</p>
<p>The behaviour at the beginning of the disabling function can be specified separately for the brightness control and optionally - if the groups and single devices have this range of functions - also for the colour temperature control and colour control. This parameter defines the behaviour of the brightness at the beginning of the disabling function.</p> <p>Switch-off: A group or single device switches off at the beginning of the disabling function.</p> <p>Preset: The brightness specified by the "Brightness value" parameter is set at the beginning of the disabling function.</p> <p>Memory value (brightness as before last switch-off): The brightness value is set that was active before the last switch-off and stored internally in the device. This memory value is stored in a non-volatile manner in the gateway so that the value is retained after the bus or mains voltage returns. After an ETS programming operation, the memory value is predefined to "100%". This value is optionally limited by the maximum brightness.</p> <p>No reaction: The operating devices of the disabled group or the single device do not react. The devices remain in the most recently set brightness state.</p> <p>Flashing: The affected devices are switched on and off cyclically during disabling. The "Time for flashing of the disabling functions" is generally configured on the parameter page "DALI System... -> General". During flashing, the logical switching state is fed back as "Switched on" and the brightness value as "Switch-on brightness". A soft ON/OFF function is not executed during flashing.</p>	
<p>Brightness value</p>	<p>1%, 2%, 3%, 4%, 5%, 6%, 7%, 8%, 9%, 10%, 15%, 20%...50%...100%</p>
<p>This parameter configures the brightness value to be retrieved at the beginning of the disabling function.</p> <p>This parameter is available only if a brightness value is to be retrieved at the beginning of the disabling function.</p>	

At start... Colour temperature	preset Memory value (colour temperature like before switching off the last time) no reaction
<p>The behaviour at the beginning of the disabling function can be specified separately for the brightness control and optionally - if the groups and single devices have this range of functions - also for the colour temperature control and colour control. This parameter defines the behaviour of the colour temperature at the beginning of the disabling function.</p> <p>Preset: The colour temperature specified by the "Colour temperature" parameter is set at the beginning of the disabling function.</p> <p>Memory value (colour temperature as before last switch-off): The colour temperature value is set that was active before the last switch-off and stored internally in the device. This memory value is stored in a non-volatile manner in the gateway so that the value is retained after the bus or mains voltage returns. After ETS programming, the memory value is predefined to "minimum colour temperature".</p> <p>No reaction: The operating devices of the disabled group or the single device do not react. The devices remain in the colour temperature state last set.</p> <p>This parameter is available only if the group and single device support this range of functions.</p>	
Colour temperature value	1,000... 2,700 ...10,000
<p>This parameter configures the colour temperature value to be recalled at the beginning of the disabling function.</p> <p>This parameter is available only if a colour temperature value is to be recalled at the beginning of the disabling function.</p>	

At start... Colour	<p>preset</p> <p>Memory value (colour like before switching off the last time)</p> <p>no reaction</p>
<p>The behaviour at the beginning of the disabling function can be specified separately for the brightness control and optionally - if the groups and single devices have this range of functions - also for the colour temperature control and colour control. This parameter defines the behaviour of the colour at the beginning of the disabling function.</p> <p>Preset: The colour specified by the parameter "Colour (RGB)" and optionally "White value (W)" is set at the beginning of the disabling function.</p> <p>Memory value (colour as before last switch-off): The colour is set that was active before the last switch-off and stored internally in the device. This memory value is stored in a non-volatile manner in the gateway so that the value is retained after the bus or mains voltage returns. After an ETS programming operation, the memory colour value is predefined at "#FFFFFF" and the optional white value at "#FF".</p> <p>No reaction: The operating devices of the disabled group or the single device do not react. The devices remain in the colour state last set.</p> <p>This parameter is available only if the group and single device support this range of functions.</p>	
Colour value (RGB)	#000000...#FFFFFF
<p>This parameter configures the RGB colour value to be retrieved at the beginning of the disabling function.</p> <p>This parameter is available only if a colour value is to be retrieved at the beginning of the disabling function.</p>	
White value (W)	0...255
<p>This parameter configures the optional white level to be retrieved at the start of the disabling function.</p> <p>This parameter is available only if a colour value is to be retrieved at the start of the disabling function and an RGBW colour space has been configured for the group or single device.</p>	

<p>At the end... Brightness</p>	<p>Switch-off track preset Memory value (brightness like before the last switch-off) no reaction flashing</p>
<p>The behaviour at the end of the disabling function can also be specified separately for the brightness control and optionally also for the colour temperature control and colour control. The behaviour is influenced by the acknowledgement object. This parameter defines the behaviour of the brightness at the end of the disabling function.</p> <p>Switch-off: A group or single device switches off at the end of the disabling function.</p> <p>Track: The set state received during the disabling function or adjusted before the disabling function can be tracked at the end of the disabling with the appropriate brightness value. During disabling, the overridden functions of the gateway (switching, dimming, value specifications) continue to be processed internally in the device. Consequently, newly received KNX telegrams are evaluated and time functions are triggered as well. At the end of the disabling, the tracked states are set. A scene recall (low priority) is not tracked.</p> <p>Preset: The brightness specified by the "Brightness value" parameter is set at the end of the disabling function.</p> <p>Memory value (brightness as before last switch-off): The brightness value is set that was active before the last switch-off and stored internally in the device. This memory value is stored in a non-volatile manner in the gateway so that the value is retained after the bus or mains voltage returns. After an ETS programming operation, the memory value is predefined to "100%". This value is optionally limited by the maximum brightness.</p> <p>No reaction: The operating devices of the disabled group or the single device do not react. The devices remain in the state most recently set by the disabling function.</p> <p>Flashing: The affected devices are switched on and off cyclically after disabling. The flashing time is generally configured on the parameter page "DALI System... -> General". During flashing, the logical switching state is fed back as "Switched on" and the brightness value as "Switch-on brightness". A soft ON/OFF function is not executed during flashing. The flashing status remains active until another bus command is received or manual operation specifies another brightness value.</p>	
<p>Brightness value</p>	<p>1%, 2%, 3%, 4%, 5%, 6%, 7%, 8%, 9%, 10%, 15%, 20%...50%...100%</p>
<p>This parameter configures the brightness value to be retrieved at the end of the disabling function.</p> <p>This parameter is available only if a brightness value is to be retrieved at the end of the disabling function.</p>	

<p>At the end...</p> <p>Colour temperature</p>	<p>track</p> <p>preset</p> <p>Memory value (colour temperature like before switching off the last time)</p> <p>no reaction</p>
<p>The behaviour at the end of the disabling function can also be specified separately for the brightness control and optionally also for the colour temperature control and colour control. The behaviour is influenced by the acknowledgement object. This parameter defines the behaviour of the colour temperature at the end of the disabling function.</p> <p>Track: The set state received during the disabling function or adjusted before the disabling function can be tracked at the end of the disabling with the appropriate colour temperature value. During disabling, the overridden functions of the gateway (switching, dimming, value specifications) continue to be processed internally in the device. Consequently, newly received KNX telegrams are evaluated and time functions are triggered as well. At the end of the disabling, the tracked states are set. A scene recall (low priority) is not tracked.</p> <p>Preset: The colour temperature specified by the "Colour temperature" parameter is set at the beginning of the disabling function.</p> <p>Memory value (colour temperature as before last switch-off): The colour temperature value is set that was active before the last switch-off and stored internally in the device. This memory value is stored in a non-volatile manner in the gateway so that the value is retained after the bus or mains voltage returns. After ETS programming, the memory value is predefined to "minimum colour temperature".</p> <p>No reaction: The operating devices of the disabled group or the single device do not react. The devices remain in the colour temperature state last set.</p> <p>This parameter is available only if the group and single device support this range of functions.</p>	
<p>Colour temperature value</p>	<p>1,000...2,700...10,000</p>
<p>This parameter configures the colour temperature value to be recalled at the end of the disabling function.</p> <p>This parameter is available only if a colour temperature value is to be retrieved at the end of the disabling function.</p>	

At the end... Colour	track preset Memory value (colour like before switching off the last time) no reaction
-------------------------	--

The behaviour at the end of the disabling function can also be specified separately for the brightness control and optionally also for the colour temperature control and colour control. The behaviour is influenced by the acknowledgement object. This parameter defines the behaviour of the colour at the end of the disabling function.

Track: The set state received during the disabling function or adjusted before the disabling function can be tracked at the end of the disabling with the appropriate colour value. During disabling, the overridden functions of the gateway (switching, dimming, value specifications) continue to be processed internally in the device. Consequently, newly received KNX telegrams are evaluated and time functions are triggered as well. At the end of the disabling, the tracked states are set. A scene recall (low priority) is not tracked.

Preset: The colour specified by the parameter "Colour (RGB)" and optionally "White value (W)" is set at the beginning of the disabling function.

Memory value (colour as before last switch-off): The colour is set that was active before the last switch-off and stored internally in the device. This memory value is stored in a non-volatile manner in the gateway so that the value is retained after the bus or mains voltage returns. After an ETS programming operation, the memory colour value is predefined at "#FFFFFF" and the optional white value at "#FF".

No reaction: The operating devices of the disabled group or the single device do not react. The devices remain in the colour state last set.

This parameter is available only if the group and single device support this range of functions.

Colour value (RGB)	#000000...#FFFFFF
This parameter configures the RGB colour value to be retrieved at the end of the disabling function. This parameter is available only if a colour value is to be retrieved at the end of the disabling function.	

White value (W)	0...255
This parameter configures the optional white level to be retrieved at the end of the disabling function. This parameter is available only if a colour value is to be retrieved at the end of the disabling function and an RGBW colour space has been configured for the group or single device.	

With forced position as supplementary function:

DALI system... -> Configuration groups -> [x] Group name -> Forced position

DALI system... -> Configuration single devices -> [x] Device name -> Forced position

Forced position "active, switch-on"	preset Memory value (brightness like before the last switch-off) no reaction
<p>A forced position influences only the brightness control of a group or single device. The colour temperature or colour - provided that the groups and single devices have this range of functions - always remains unchanged in a forced position. This parameter defines the behaviour to be carried out when a forced position is activated via the communication object and the group or the single device is to be forcibly switched on.</p> <p>Preset: The DALI operating devices set themselves to the brightness configured in the "Brightness value" parameter in the event of a restraint.</p> <p>No reaction: The bus operation is locked but the operating devices show no response and remain in the most recently set brightness state.</p> <p>Memory value (brightness before last switch-off): The brightness value is set that was active before the last switch-off and stored internally in the device. This memory value is stored in a non-volatile manner in the gateway so that the value is retained after the bus or mains voltage returns. After an ETS programming operation, the memory value is predefined to "100%". This value is optionally limited by the maximum brightness.</p>	
Brightness value	1%, 2%, 3%, 4%, 5%, 6%, 7%, 8%, 9%, 10%, 15%, 20%...50%...100%
<p>This parameter configures the brightness value to be recalled when a forced position is activated.</p> <p>This parameter is available only if a brightness value is to be retrieved when the forced position is activated.</p>	
Forced position "active, switch-off"	Switch-off
<p>The behaviour that is executed when a forced position is activated via the communication object and the group or single device is to be forcibly switched off is permanently defined as "Switch-off". This parameter is therefore not adjustable.</p>	
Forced position end "inactive"	track no reaction
<p>At the end of the forced position, the configured behaviour is executed here. Bus operation is enabled again.</p> <p>Track: The state received during the forced position function or the brightness value adjusted before the function can be tracked at the end of the forced position. Any time functions still in progress will also be taken into account if necessary. A scene recall (low priority) is not tracked.</p> <p>No reaction: The operating devices show no response and remain in the brightness state last selected by the forced position.</p>	

after bus/mains voltage return	no forced position Forced position active, switch-on Forced position active, switch-off state as before bus/mains voltage failure
<p>The behaviour of the forced position after a bus or mains voltage return can be specified by this parameter. This initialises the forced position after a device reset.</p> <p>After bus or mains voltage return, the configured state is transferred to the "Forced position - Activate/Deactivate" communication object. When a forced position is activated, the group or the single device is immediately activated and interlocked accordingly by forced control after bus/mains voltage return until a forced control takes place via the KNX. In this case, the parameter "After bus voltage return" is not evaluated.</p> <p>State before bus/mains voltage failure: The last existing and internally stored state of the forced position before bus or mains voltage failure will be tracked. An ETS programming operation deletes the stored state (reaction in that case same as with "no forced position active"). If the tracked state corresponds to "No forced position active", the force-independent parameter "After bus voltage return" will be executed on return of bus voltage. If forced position is activated, the DALI operating devices are switched on to the brightness value predefined by the parameter "Forced position 'active, switch-on'".</p>	

9.5.4 Objects for supplementary functions

Function	Name	Type	DPT	Flag
Disabling function - Activate / Deactivate	Group 1...32 / Single device 1...64	1-bit	1.003	C, -, W, -, U
1-bit object for activation and deactivation of the disabling function (polarity configurable).				
Function	Name	Type	DPT	Flag
Disabling function - Acknowledgment	Group 1...32 / Single device 1...64	1-bit	1.016	C, -, W, -, U
1-bit object to acknowledge an active disabling function. This object is visible only if the acknowledgement is to be used with the disabling function ("1" = disabling function is deactivated / "0" = no reaction).				
Function	Name	Type	DPT	Flag
Forced position - Activate / Deactivate	Group 1...32 / Single device 1...64	2-bit	2.001	C, -, W, -, U
2-bit object for activating or deactivating the forced position. The polarity is fixed by the telegram.				

9.6 Status functions

9.6.1 Switching status and brightness value

The gateway can track the current switching state and brightness value of a group or single device by means of separate status objects and also transmit them to the KNX, provided the bus voltage is switched on. The following status objects can be enabled independently of each other for each group and each configured single device...

- Switching status feedback (1-bit),
- Feedback brightness value (1-byte).

The gateway calculates the object value of the status objects during each switching or dimming process. The gateway tracks the switching state or brightness value and updates the status objects, even if a group or single device is activated by the manual operation or scene function.

The switching status object is updated during the following events...

- immediately after switch-on, (if necessary, only after a switch-on delay has elapsed and at the beginning of a soft ON dimming process / also in the event of a staircase function),
- after switch-off, (if necessary, only after a switch-off delay has elapsed and at the end of a soft OFF dimming process / also in the event of a staircase function),
- immediately after switching off by means of the automatic switch-off function,
- at the beginning of a dimming process when dimming ON (relative dimming up or brightness value = 1...100%),
- at the end of a dimming procedure when dimming OFF (brightness value = 0 %),
- if the switching state changes in normal operation (therefore not in the event of a dimming process without changing the switching state e. g. from 10% to 50 % brightness),
- at the start or end of a disabling or forced position function (if the switching state changes as a result),
- at the beginning of a scene recall (whenever the switching state is consequently changed),

The brightness value status object is updated in the event of the following events...

- at the end of a relative (4-bit) or absolute (1-byte) dimming process,
- after switch-on, if the switch-on brightness is set (if necessary, first only a switch-on delay has elapsed and at the end of a soft ON dimming process / also in the event of a staircase function),
- after switch-off, (if necessary, only after a switch-off delay has elapsed and at the end of a soft OFF dimming process / also in the event of a staircase function),
- immediately after switching off by means of the automatic switch-off function,

- if, in normal operation, the brightness value changes (if a brightness value specification exceeds/undershoots the maximum/minimum brightness as a result of relative or absolute dimming from outside or exceeds the maximum brightness, the gateway updates brightness value feedback according to the maximum brightness or minimum brightness),
 - at the start or end of a disabling or forced position function (if the brightness value changes as a result),
 - at the beginning of a scene recall (if this changes the brightness value),
- i** If the bus/mains voltage returns or after an ETS programming operation, the status objects are initially initialised with the value "0". After the device initialisation (indication "--" on the display), the gateway evaluates the parameters for the reset behaviour and sets the state of the groups and single devices accordingly. If the reset behaviour is set to "no reaction", the switching and brightness value status only correspond to the actual state if the group or single device has been controlled at least once via the KNX or by manual operation.
- i** In the case of enabling function as supplementary function: A flashing group or single device is always signalled back as "switched on" and with switch-on brightness. The switching status is transmitted also for disabled groups or devices if the group or single device is adjusted, for example, by a manual operation.

Activating the switching status

The switching status is implemented as an active signalling object so that the object value is also transmitted directly to the KNX during each update. The ETS automatically sets by default the communication flags of the status object required for proper functioning.

- i** If the "Transmit" flag of the switching status object is deleted, the object can be used as a passive status object.

The "Switching status" parameter is available separately for each group or single device on the parameter page "DALI system... -> Configuration groups -> [x] Group name -> Status" or "DALI system... -> Configuration single devices -> [x] Device name -> Status" if the enabling has taken place on the corresponding parameter page for the status.

- Activate the parameter.
The object "Switching -Status" is enabled. The switching status is transmitted once the status is updated.
- Deactivate the parameter.
No switching status is available.

Activating the brightness value status

The brightness value status is implemented as an active signalling object so that the object value is also transmitted directly to the KNX with each update. The ETS automatically sets by default the communication flags of the status object required for proper functioning.

- i** If the "Transmit" flag of the brightness value status object is deleted, the object can be used as a passive status object.

The "Brightness value" parameter is available separately for each group or single device on the parameter page "DALI system... -> Configuration groups -> [x] Group name -> Status" or "DALI system... -> Configuration single devices -> [x] Device name -> Status" if the enabling has taken place on the corresponding parameter page for the status.

- Activate the parameter.
The object "Brightness value - Status" is enabled. The brightness value status is transmitted as soon as the status is updated.
- Deactivate the parameter.
No brightness value status is available.

Setting the updating of the switching status

In the ETS, it can be defined when the gateway updates the feedback value for the switching status. The object value updated last by the gateway is then actively signalled to the KNX, provided the "Transmit" flag is set on the communication object.

The parameter "Updating of the object value" is separately available for each group or single device on the parameter page "DALI system... -> Configuration groups -> [x] Group name -> Status" or "DALI system... -> Configuration single devices -> [x] Device name -> Status".

The switching status must be enabled.

- Set the parameter to "after each update object 'Switching'/'Central switching'".
The gateway updates the feedback value in the object once a new telegram is received on the input objects "Switching - Setting" or "Central function..." - Switching". A new telegram is also then actively transmitted to the KNX each time. The telegram value does not necessarily have to change. Consequently, in the event of, for example, cyclical telegrams to the input objects, the corresponding switching status telegrams are also generated.

With other functions of the gateway (e.g. at the beginning or end of a disabling or forced position function or in the event of a manual operation or scene recall), no status is sent in this setting if the switching status does not change.

- Set the parameter to "Only if the feedback value changes".

The gateway updates the switching status only if the telegram value (e.g. "OFF" to "ON") also changes. If the telegram value does not change (e.g. in the case of cyclical telegrams to the input objects with the same telegram value), the status then remains unchanged. Consequently, no telegram with the same content is output repeatedly either.

This setting is recommended, for instance, if the objects "Switching - Setting" and "Switching - Status" are linked to an identical group address. This is often the case when activating by means of light scene push-button sensors (recall and storage function).

Setting the update of the brightness value status

In the ETS, it can be defined when the gateway updates the feedback value for the brightness value status. The object value updated last by the gateway is then actively signalled to the KNX, provided the "Transmit" flag is set on the communication object.

The parameter "Updating of the object value" is separately available for each group or single device on the parameter page "DALI system... -> Configuration groups -> [x] Group name -> Status" or "DALI system... -> Configuration single devices -> [x] Device name -> Status".

The brightness value status must be enabled.

- Set the parameter to "after each update 'Brightness value'/'Central brightness value' object".

The gateway updates the feedback value in the object as soon as a new telegram is received at the input objects "Brightness value - Setting" or "Central function... - Brightness value". A new telegram is also then actively transmitted to the KNX each time. The telegram value does not necessarily have to change. Consequently, the corresponding brightness value status telegrams are also generated, for example, in the event of cyclical telegrams to the input objects.

With other functions of the gateway (e.g. at the beginning or end of a disabling or forced position function or in the event of a manual operation or scene recall), no status is sent in this setting if the brightness value status does not change.

- Set the parameter to "Only if the feedback value changes".

The gateway updates the brightness value status only if the telegram value also changes. If the telegram value does not change (e.g. in the case of cyclical telegrams to the input objects with the same telegram value), the status then remains unchanged. Consequently, no telegram with the same content is output repeatedly either.

This setting is recommended, for instance, if the objects "Brightness value - Setting" and "Brightness value - Status" are linked to an identical group address. This is often the case when activating by means of light scene push-button sensors (recall and storage function).

9.6.2 Colour temperature

The gateway can track the set colour temperature of a DALI group and single device via a separate 2-byte status object according to DPT 7.600 and can also transmit it to the KNX, provided the bus voltage is switched on. In addition, the gateway can indicate whether an externally specified colour temperature is valid ("ON" object value) or invalid ("OFF" object value) by means of a separate 1-bit status object. An invalid colour temperature exists if the specified value violates the set limits of the minimum and maximum colour temperature.

The gateway determines the object value of the status objects each time the colour temperature is influenced. The gateway tracks the colour temperature value and updates the status objects even if a group or single device is controlled by the scene function or HCL matrices.

The status object "Colour temperature - Status" is updated in the event of the following events...

- after a completed relative or absolute colour temperature dimming process. If the group or single device is switched off and a colour temperature dimming process is carried out, the gateway updates the colour temperature status only if the "Switch-on colour temperature" parameter is configured to the "Track" setting.
- immediately after switching on a group or single device, but only if the colour temperature value differs from the last value fed back,
- at the beginning of a scene recall (whenever this changes the colour temperature),
- in the event of an ongoing HCL daytime colour temperature sequence, provided there are changes to the colour temperature.

i If the bus/mains voltage returns or after an ETS programming operation, the colour temperature status object is initially initialised with the value "0". After the device initialisation (indication of "--" on the display), the gateway evaluates the parameters for the reset behaviour, sets the state of the groups and single devices accordingly and updates the status object.

i If a colour temperature specification exceeds or undershoots the minimum or maximum colour temperature as a result of relative or absolute dimming specified externally, the gateway updates the status according to the minimum or maximum temperature.

The status object "Colour temperature invalid - Status" is updated during the following events...

- when a new absolute colour temperature is specified (depending on the configured transmission behaviour),
- always after a device reset (ETS programming operation, bus/mains voltage return), with the "valid colour temperature" status.

Activating the colour temperature status

The colour temperature status is implemented as an active signalling object so that the object value is transmitted also directly to the KNX with each update. The ETS automatically sets by default the communication flags of the status object required for proper functioning.

- i** If the "Transmit" flag of the colour temperature status object is deleted, the object can be used as a passive status object.

The "Colour temperature" parameter is separately available for each group or single device on the parameter page "DALI system... -> Configuration groups -> [x] Group name -> Status" or "DALI system... -> Configuration single devices -> [x] Device name -> Status" if the enabling has taken place on the corresponding parameter page for the status.

- Activate the parameter.
The object "Colour temperature - Status" is enabled. The colour temperature status is transmitted as soon as the status is updated.
- Deactivate the parameter.
No colour temperature status is available.

Activating the status for an invalid colour temperature

The status for an invalid colour temperature is implemented as an active message object, so that the object value is transmitted also directly to the KNX with each update. The ETS automatically sets by default the communication flags of the status object required for proper functioning.

- i** If the "Transmit" flag of the status object is deleted, the object can be used as a passive status object.

The "Invalid colour temperature" parameter is separately available for each group or single device on the parameter page "DALI system... -> Configuration groups -> [x] Group name -> Status" or "DALI system... -> Configuration single devices -> [x] Device name -> Status" if the enabling has taken place on the corresponding parameter page for the status.

- Activate the parameter.
The object "Colour temperature invalid - Status" is enabled. The status for an invalid colour temperature is transmitted as soon as the status is updated.
- Deactivate the parameter.
There is no status available for an invalid colour temperature.

Setting the colour temperature status update

In the ETS, it can be defined when the gateway updates the feedback value for the colour temperature status. The object value updated last by the gateway is then actively signalled to the KNX, provided the "Transmit" flag is set on the communication object.

The parameter "Updating of the object value" is separately available for each group or single device on the parameter page "DALI system... -> Configuration groups -> [x] Group name -> Status" or "DALI system... -> Configuration single devices -> [x] Device name -> Status".

The colour temperature status must be enabled.

- Set the parameter to "after each update of feedback value".

The gateway updates the feedback value in the object as soon as a new telegram for the specification of a colour temperature value is received or a value is specified by an internal function of the gateway (e. g. scene function, HCL matrices). The default colour temperature value does not necessarily have to change. Consequently, in the event of, for example, cyclical telegrams to the input objects, the corresponding colour temperature status telegrams are also generated.

- Set the parameter to "Only if the feedback value changes".

The gateway updates the colour temperature status only when the telegram value also changes. If the telegram value does not change (e.g. in the case of cyclical telegrams to the input objects with the same telegram value), the status then remains unchanged. Consequently, no telegram with the same content is output repeatedly either.

This setting is recommended, for instance, if the objects "Absolute colour temperature - Setting" and "Colour temperature -Status" are linked to an identical group address. This is often the case when activating by means of light scene push-button sensors (recall and storage function).

Setting an invalid colour temperature status update

In the ETS it can be defined when the gateway updates the feedback value for the status of an invalid colour temperature. The object value updated last by the gateway is then actively signalled to the KNX, provided the "Transmit" flag is set on the communication object.

The parameter "Updating of the object value" is separately available for each group or single device on the parameter page "DALI system... -> Configuration groups -> [x] Group name -> Status" or "DALI system... -> Configuration single devices -> [x] Device name -> Status".

The status of an invalid colour temperature must be enabled.

- Set the parameter to "after each update of feedback value".

The gateway updates the feedback value in the object as soon as a new telegram is received to specify a colour temperature value. The default colour temperature value does not necessarily have to change. Consequently, in the event of, for example, cyclical telegrams to the input objects, the corresponding status telegrams are also generated.

- Set the parameter to "Only if the feedback value changes".

The gateway updates the status of an invalid colour temperature only if the telegram value also changes. If the telegram value does not change (e.g. in the case of cyclical telegrams to the input objects with the same telegram value), the status then remains unchanged. Consequently, no telegram with the same content is output repeatedly either.

9.6.3 Colour

The gateway can track the set colour of a group and single device by means of separate objects and transmit it also to the KNX, provided the bus voltage is switched on. The data format of the status objects depends on the selected colour space (RGB[W] combined, RGB[W] individually, HSV[W]) and is based on the format of the input objects.

The gateway determines the object value of the status objects each time the colour is affected. Even if a group or single device is controlled by the scene function, a colour wheel sequence or the CTM matrices, the gateway tracks the colour value and updates the status objects.

The status objects are updated during the following events...

- after a completed relative or absolute colour dimming process. If the group or single device is switched off and a colour dimming process is carried out, the gateway updates the status of the colour, provided the parameter "Switch-on colour" is configured to the "track" setting.
- immediately after switching on a group or single device, but only if the colour differs from the last value that was fed back,
- at the beginning of a scene recall (whenever this changes the colour),
- in the event of an ongoing colour wheel sequence or CTM daytime colour temperature sequence, provided changes to the colour occur.

i When the bus/mains voltage returns or after an ETS programming operation, the status objects of the colour are first initialised with the value "0". After the device initialisation (indication of "--" on the display), the gateway evaluates the parameters for the reset behaviour and sets the state of the groups and single devices accordingly and updates the status objects.

Activating the colour status

The colour status is implemented with active signalling objects so that the object values are transmitted also directly to the KNX during each update. The ETS automatically sets the communication flags of the status objects required for proper functioning as a standard feature.

i If the "Transmit" flags of the status objects are deleted, the objects can be used as passive status objects.

The "Colour" parameter is separately available for each group or single device on the parameter page "DALI system... -> Configuration groups -> [x] Group name -> Status" or "DALI system... -> Configuration single devices -> [x] Device name -> Status" if the enabling has taken place on the corresponding parameter page for the status.

- Activate the parameter.
The objects for the colour status are enabled. The colour status is transmitted as soon as the status is updated.
- Deactivate the parameter.
No colour status is available.

Setting the updating of the colour status

In the ETS, it can be defined when the gateway updates the feedback values for the colour status. The object values updated last by the gateway are then actively signalled to the KNX, provided the "Transmit" flags are set on the communication objects.

The parameter "Updating of the object value" is separately available for each group or single device on the parameter page "DALI system... -> Configuration groups -> [x] Group name -> Status" or "DALI system... -> Configuration single devices -> [x] Device name -> Status".

The colour status must be enabled.

- Set the parameter to "after each update of feedback value".
The gateway updates the feedback value in the objects as soon as new telegrams are received to specify a colour value or values are specified by an internal function of the gateway (e.g. scene function, colour wheel sequence, HCL matrices). The default colour value does not necessarily have to change. Consequently, corresponding colour status telegrams are also generated, for example, in the event of cyclical telegrams to the input objects.
- Set the parameter to "Only if the feedback value changes".
The gateway updates the colour status only when the telegram values change. If the telegram values do not change (e. g. in the case of cyclical telegrams to the input objects with the same telegram value), the status remains unchanged. Consequently, no telegram with the same content is output repeatedly either.

9.6.4 Reset behaviour and cyclical transmission

Setting the status when the bus/mains voltage returns or after ETS programming

Any status can be transmitted to the KNX after a bus or mains voltage return or after an ETS programming operation, provided the "Transmit" flag is set on the communication object and the reset behaviour of the underlying functions is not configured to

"no reaction". In these cases, the status telegram can be transmitted with a time delay, whereby the delay time is set globally for all groups together (refer to "Description for group-independent and device-independent functions -> Status functions -> Delay after bus/mains voltage return").

The "Behaviour after bus/mains voltage return" parameter is separately available for each group or single device on the parameter page "DALI system... -> Configuration groups -> [x] Group name -> Status" or "DALI system... -> Configuration single devices -> [x] Device name -> Status" for each status function.

- Activate the parameter.

The status is transmitted after a delay after the bus or mains voltage returns or an ETS programming operation. No status is transmitted during a delay even if the state changes during this delay.

The delay time is started immediately after the ETS programming operation is completed, i. e. already before the device is initialised (indication of "--" on the display). If the initialisation of the gateway (due to many groups and single devices) takes longer than the delay time configured in the ETS, the status is transmitted only after the initialisation phase has been completed.

- Deactivate the parameter.

The status is transmitted immediately after the bus or mains voltage returns or an ETS programming operation directly during the device initialisation.

Setting the cyclical transmission of the switching status

Each status can be transmitted also cyclically in addition to being transmitted when updated.

The "Cyclical transmission" parameter is separately available for each group or single device on the parameter page "DALI system... -> Configuration groups -> [x] Group name -> Status" or "DALI system... -> Configuration single devices -> [x] Device name -> Status" for each status function.

- Activate the parameter.

Cyclical transmission is activated. The cycle time is defined uniformly for all status messages of the affected group and single device by the parameter with the same name on the same parameter page.

- Deactivate the parameter.

Cyclical transmission is deactivated so that the status is transmitted to the KNX only if a state is updated.

i No cyclical transmission takes place during an active delay time or device initialisation (indication of "--" on the display).

i With the switching status and brightness value status, the cyclical transmission after a device reset does not begin until a defined state is set for the groups and single devices by the parameters "After ETS programming operation" or "After bus/mains voltage return". If the reset behaviour is set to "no reaction",

the cyclical transmission for the switching and brightness value status does not begin until the group or single device has been controlled at least once via the KNX or by manual operation.

9.6.5 Parameters for status functions

DALI system... -> Configuration groups -> [x] Group name -> Enabled functions

DALI system... -> Configuration single devices -> [x] Device name -> Enabled functions

Status	Checkbox (yes/no)
This parameter globally enables the status function for the selected group or single device. When enabled, the "Status" parameter page is visible.	

DALI system... -> Configuration groups -> [x] Group name -> Status

DALI system... -> Configuration single devices -> [x] Device name -> Status

Cycle time	0...23 h 0...2...59 min 0/(10)...59 s
Each status can be transmitted also cyclically in addition to being transmitted when updated. The cycle time is defined uniformly for all status messages of the affected group and single device by this parameter.	

Parameters for switching status

Switching status	Checkbox (yes/no)
The gateway can track the current switching state of a group and single device via a separate status object and can also transmit them to the KNX, provided the bus voltage is switched on.	
Activated: The object "Switching - Status" is enabled. The switching status is transmitted once the status is updated.	
Deactivated: No switching status is available.	

Switching status Updating of the object value	After each update "Switching"/"Central" object only if the feedback value changes
--	---

It can be defined here when the gateway updates the feedback value for the switching status. The object value updated last by the gateway is then actively signalled to the KNX, provided the "Transmit" flag is set on the communication object.

After each update object "Switching"/"Central switching": The gateway updates the feedback value in the object as soon as a new telegram is received at the input objects "Switching - Setting" or "Central function... - Switching". A new telegram is also then actively transmitted to the KNX each time. The telegram value does not necessarily have to change. Consequently, in the event of, for example, cyclical telegrams to the input objects, the corresponding switching status telegrams are also generated. With other functions of the gateway (e.g. at the beginning or end of a disabling or forced position function or in the event of a manual operation or scene recall), no status is sent in this setting if the switching status does not change.

Only if the feedback value changes: The gateway updates the switching status only when the telegram value also changes (e.g. "OFF" to "ON"). If the telegram value does not change (e.g. in the case of cyclical telegrams to the input objects with the same telegram value), the status then remains unchanged. Consequently, no telegram with the same content is output repeatedly either. This setting is recommended, for instance, if the objects "Switching - Setting" and "Switching - Status" are linked to an identical group address. This is often the case when activating by means of light scene push-button sensors (recall and storage function).

Switching status Delay after bus/mains voltage return	Checkbox (yes/no)
--	-------------------

The switching status can be transmitted to the KNX after the bus or mains voltage returns or after an ETS programming operation, provided the "Transmit" flag is set on the communication object and the reset behaviour of the underlying functions is not configured to "no reaction". In these cases, the status telegram can be transmitted with a time delay, whereby the delay time is set globally for all groups together.

Activated: The status is transmitted after a delay after the bus or mains voltage returns or an ETS programming operation. No status is transmitted during a delay even if the state changes during this delay. The delay time is started immediately after the ETS programming operation is completed, i. e. already before the device is initialised (indication of "--" on the display). If the initialisation of the gateway (due to many groups and single devices) takes longer than the delay time configured in the ETS, the status is transmitted only after the initialisation phase has been completed.

Deactivated: The status is transmitted immediately after the bus or mains voltage returns or after an ETS programming operation during the device initialisation.

Switching status	Checkbox (yes/no)
Cyclical transmission	
<p>The switching status can also be transmitted cyclically in addition to being transmitted when updated.</p> <p>Activated: Cyclical transmission is activated. The cycle time is defined uniformly for all status messages of the affected group and single device by the parameter with the same name on the same parameter page.</p> <p>Deactivated: Cyclical transmission is deactivated so that the status is transmitted to the KNX only when a state is updated.</p>	

Parameters for brightness value status

Brightness value	Checkbox (yes/no)
<p>The gateway can track the current brightness value of a group or single device via a separate status object and can also transmit them to the KNX, provided the bus voltage is switched on.</p> <p>Activated: The object "Brightness value - Status" is enabled. The brightness value status is transmitted as soon as the status is updated.</p> <p>Deactivated: No brightness value status is available.</p>	

Brightness value	after each update "Brightness value"/"Central brightness value" object
Updating of the object value	only if the feedback value changes
<p>It can be defined here when the gateway updates the feedback value for the brightness value status. The object value updated last by the gateway is then actively signalled to the KNX, provided the "Transmit" flag is set on the communication object.</p> <p>after each update object "Brightness value"/"Central brightness value": The gateway updates the feedback value in the object as soon as a new telegram is received at the input objects "Brightness value - Setting" or "Central function... - Brightness value". A new telegram is also then actively transmitted to the KNX each time. The telegram value does not necessarily have to change. Consequently, the corresponding brightness value status telegrams are also generated, for example, in the event of cyclical telegrams to the input objects. With other functions of the gateway (e.g. at the beginning or end of a disabling or forced position function or in the event of a manual operation or scene recall), no status is sent in this setting if the brightness value status does not change.</p> <p>Only if the feedback value changes: The gateway updates the brightness value status only if the telegram value also changes. If the telegram value does not change (e.g. in the case of cyclical telegrams to the input objects with the same telegram value), the status then remains unchanged. Consequently, no telegram with the same content is output repeatedly either. This setting is recommended, for instance, if the objects "Brightness value - Setting" and "Brightness value - Status" are linked to an identical group address. This is often the case when activating by means of light scene push-button sensors (recall and storage function).</p>	

Brightness value	Checkbox (yes/no)
Delay after bus/mains voltage return	
<p>The brightness value status can be transmitted to the KNX after the bus or mains voltage returns or after an ETS programming operation, provided the "Transmit" flag is set on the communication object and the reset behaviour of the underlying functions is not configured to "no reaction". In these cases, the status telegram can be transmitted with a time delay, whereby the delay time is set globally for all groups together.</p> <p>Activated: The status is transmitted after a delay after the bus or mains voltage returns or an ETS programming operation. No status is transmitted during a delay even if the state changes during this delay. The delay time is started immediately after the ETS programming operation is completed, i. e. already before the device is initialised (indication of "--" on the display). If the initialisation of the gateway (due to many groups and single devices) takes longer than the delay time configured in the ETS, the status is transmitted only after the initialisation phase has been completed.</p> <p>Deactivated: The status is transmitted immediately after the bus or mains voltage returns or after an ETS programming operation during the device initialisation.</p>	

Brightness value	Checkbox (yes/no)
Cyclical transmission	
<p>The brightness value status can also be sent out cyclically in addition to being transmitted when updated.</p> <p>Activated: Cyclical transmission is activated. The cycle time is defined uniformly for all status messages of the affected group and single device by the parameter with the same name on the same parameter page.</p> <p>Deactivated: Cyclical transmission is deactivated so that the status is transmitted to the KNX only when a state is updated.</p>	

Parameters for colour temperature status

Colour temperature	Checkbox (yes/no)
<p>The gateway can track the set colour temperature of a DALI group and single device via a separate 2-byte status object according to DPT 7.600 and can also transmit it to the KNX, provided the bus voltage is switched on.</p> <p>Activated: The object "Colour temperature - Status" is enabled. The colour temperature status is transmitted as soon as the status is updated.</p> <p>Deactivated: No colour temperature status is available.</p>	

Colour temperature Updating of the object value	after each update of feedback value only if the feedback value changes
<p>At this point, you can define when the gateway updates the feedback value for the colour temperature status. The object value updated last by the gateway is then actively signalled to the KNX, provided the "Transmit" flag is set on the communication object.</p> <p>after each update of feedback value: The gateway updates the feedback value in the object as soon as a new telegram is received to specify a colour temperature value or a value is specified by an internal function of the gateway (e. g. scene function, HCL matrices). The default colour temperature value does not necessarily have to change. Consequently, in the event of, for example, cyclical telegrams to the input objects, the corresponding colour temperature status telegrams are also generated.</p> <p>only if the feedback value changes: The gateway updates the colour temperature status only when the telegram value also changes. If the telegram value does not change (e.g. in the case of cyclical telegrams to the input objects with the same telegram value), the status then remains unchanged. Consequently, no telegram with the same content is output repeatedly either. This setting is recommended, for instance, if the objects "Absolute colour temperature - Setting" and "Colour temperature -Status" are linked to an identical group address. This is often the case when activating by means of light scene push-button sensors (recall and storage function).</p>	

Colour temperature Delay after bus/mains voltage return	Checkbox (yes/no)
<p>The colour temperature status can be transmitted to the KNX after the bus or mains voltage returns or after an ETS programming operation, provided the "Transmit" flag is set on the communication object and the reset behaviour of the underlying functions is not configured to "no reaction". In these cases, the status telegram can be transmitted with a time delay, whereby the delay time is set globally for all groups together.</p> <p>Activated: The status is transmitted after a delay after the bus or mains voltage returns or an ETS programming operation. No status is transmitted during a delay even if the state changes during this delay. The delay time is started immediately after the ETS programming operation is completed, i. e. already before the device is initialised (indication of "--" on the display). If the initialisation of the gateway (due to many groups and single devices) takes longer than the delay time configured in the ETS, the status is transmitted only after the initialisation phase has been completed.</p> <p>Deactivated: The status is transmitted immediately after the bus or mains voltage returns or after an ETS programming operation during the device initialisation.</p>	

Colour temperature Cyclical transmission	Checkbox (yes/no)
<p>The colour temperature status can be transmitted also cyclically in addition to being transmitted when updated.</p> <p>Activated: Cyclical transmission is activated. The cycle time is defined uniformly for all status messages of the affected group and single device by the parameter with the same name on the same parameter page.</p> <p>Deactivated: Cyclical transmission is deactivated so that the status is transmitted to the KNX only when a state is updated.</p>	
Invalid colour temperature	Checkbox (yes/no)
<p>In addition to the status for displaying the current colour temperature, the gateway can use a separate 1-bit status object to indicate whether an externally specified colour temperature is valid ("ON" object value) or invalid ("OFF" object value). An invalid colour temperature exists if the specified value violates the set limits of the minimum and maximum colour temperature.</p> <p>Activated: The object "Colour temperature invalid - Status" is enabled. The status for an invalid colour temperature is transmitted as soon as the status is updated.</p> <p>Deactivated: No status is available for an invalid colour temperature.</p>	
Invalid colour temperature Updating of the object value	after each update of feedback value only if the feedback value changes
<p>At this point, you can define when the gateway updates the feedback value for the status of an invalid colour temperature. The object value updated last by the gateway is then actively signalled to the KNX, provided the "Transmit" flag is set on the communication object.</p> <p>after each update of feedback value: The gateway updates the feedback value in the object as soon as a new telegram is received to specify a colour temperature value. The default colour temperature value does not necessarily have to change. Consequently, in the event of, for example, cyclical telegrams to the input objects, the corresponding status telegrams are also generated.</p> <p>only if the feedback value changes: The gateway updates the status of an invalid colour temperature only if the telegram value also changes. If the telegram value does not change (e.g. in the case of cyclical telegrams to the input objects with the same telegram value), the status then remains unchanged. Consequently, no telegram with the same content is output repeatedly either.</p>	

Invalid colour temperature	Checkbox (yes/no)
Delay after bus/mains voltage return	
<p>The status for an invalid colour temperature can be transmitted to the KNX after the bus or mains voltage returns or after an ETS programming operation, provided the "Transmit" flag is set on the communication object and the reset behaviour of the underlying functions is not configured to "no reaction". In these cases, the status telegram can be transmitted with a time delay, whereby the delay time is set globally for all groups together.</p> <p>Activated: The status is transmitted after a delay after the bus or mains voltage returns or an ETS programming operation. No status is transmitted during a delay even if the state changes during this delay. The delay time is started immediately after the ETS programming operation is completed, i. e. already before the device is initialised (indication of "--" on the display). If the initialisation of the gateway (due to many groups and single devices) takes longer than the delay time configured in the ETS, the status is transmitted only after the initialisation phase has been completed.</p> <p>Deactivated: The status is transmitted immediately after the bus or mains voltage returns or after an ETS programming operation during the device initialisation.</p>	

Invalid colour temperature	Checkbox (yes/no)
Cyclical transmission	
<p>The status for an invalid colour temperature can be transmitted also cyclically in addition to being transmitted when updated.</p> <p>Activated: Cyclical transmission is activated. The cycle time is defined uniformly for all status messages of the affected group and single device by the parameter with the same name on the same parameter page.</p> <p>Deactivated: Cyclical transmission is deactivated so that the status is transmitted to the KNX only when a state is updated.</p>	

Parameters for colour status

Colour	Checkbox (yes/no)
<p>The gateway can track the set colour of a group and single device by means of separate objects and transmit it also to the KNX, provided the bus voltage is switched on. The data format of the status objects depends on the selected colour space (RGB[W] combined, RGB[W] individually, HSV[W]) and is based on the format of the input objects.</p> <p>Activated: The objects for the colour status are enabled. The colour status is transmitted as soon as the status is updated.</p> <p>Deactivated: No colour status is available.</p>	

Colour Updating of the object value	after each update of feedback value only if the feedback value changes
<p>At this point, you can define when the gateway updates the feedback values for the colour status. The object values updated last by the gateway are then actively signalled to the KNX, provided the "Transmit" flags are set on the communication objects.</p> <p>after each update of feedback value: The gateway updates the feedback value in the objects as soon as new telegrams are received to specify a colour value or values are specified by an internal function of the gateway (e. g. scene function, colour wheel sequence, HCL matrices). The default colour value does not necessarily have to change. Consequently, corresponding colour status telegrams are also generated, for example, in the event of cyclical telegrams to the input objects.</p> <p>only if the feedback value changes: The gateway updates the colour status only when the telegram values also change. If the telegram values do not change (e. g. in the case of cyclical telegrams to the input objects with the same telegram value), the status remains unchanged. Consequently, no telegram with the same content is output repeatedly either.</p>	
Colour Delay after bus/mains voltage return	Checkbox (yes/no)
<p>The colour status can be transmitted to the KNX after the bus or mains voltage returns or after an ETS programming operation, provided the "Transmit" flag is set on the communication object and the reset behaviour of the underlying functions is not configured to "no reaction". In these cases, the status telegram can be transmitted with a time delay, whereby the delay time is set globally for all groups together.</p> <p>Activated: The status is transmitted after a delay after the bus or mains voltage returns or an ETS programming operation. No status is transmitted during a delay even if the state changes during this delay. The delay time is started immediately after the ETS programming operation is completed, i. e. already before the device is initialised (indication of "--" on the display). If the initialisation of the gateway (due to many groups and single devices) takes longer than the delay time configured in the ETS, the status is transmitted only after the initialisation phase has been completed.</p> <p>Deactivated: The status is transmitted immediately after the bus or mains voltage returns or after an ETS programming operation during the device initialisation.</p>	
Colour Cyclical transmission	Checkbox (yes/no)
<p>The colour status can be transmitted also cyclically in addition to being transmitted when updated.</p> <p>Activated: Cyclical transmission is activated. The cycle time is defined uniformly for all status messages of the affected group and single device by the parameter with the same name on the same parameter page.</p> <p>Deactivated: Cyclical transmission is deactivated so that the status is transmitted to the KNX only when a state is updated.</p>	

9.6.6 Objects for status functions

Function	Name	Type	DPT	Flag
Switching - Status	Group 1...32 / Single device 1...64	1-bit	1.001	C, R, -, T, A
1-bit object for status indication of the current switching state of the group or single device.				

Function	Name	Type	DPT	Flag
Brightness value - Status	Group 1...32 / Single device 1...64	1-byte	5.001	C, R, -, T, A
1-byte object for status indication of the set brightness of the group or single device.				

Function	Name	Type	DPT	Flag
Colour temperature - Status	Group 1...32 / Single device 1...64	2-byte	7.600	C, R, -, T, A
2-byte object for status indication of the set colour temperature. This object is available only if the group or single device has the "Colour temperature control" function range.				

Function	Name	Type	DPT	Flag
Colour temperature invalid - Status	Group 1...32 / Single device 1...64	1-bit	1.002	C, R, -, T, A
1-bit object for feedback of an invalid colour temperature set ("1" = colour temperature invalid, "0" = colour temperature valid). A colour temperature set externally is invalid if this violates the set limits of the minimum and maximum colour temperature. After a device reset (ETS programming operation, mains voltage return), the "valid colour temperature" state is always transmitted if an object is actively transmitting. This object is available only if the group or single device has the "Colour temperature control" function range.				

Function	Name	Type	DPT	Flag									
Colour RGB (value) - Status	Group 1...32 / Single device 1...64	3-byte	232.600	C, R, -, T, A									
3-byte object for status indication of the currently set RGB light colour.													
<table border="1" style="width: 100%; text-align: center;"> <tr> <td style="width: 33%;">byte 3 (MSB)</td> <td style="width: 33%;">byte 2</td> <td style="width: 33%;">byte 1 (LSB)</td> </tr> <tr> <td style="background-color: red; color: white;">red</td> <td style="background-color: green; color: white;">green</td> <td style="background-color: blue; color: white;">blue</td> </tr> <tr> <td>23</td> <td></td> <td>0</td> </tr> </table>					byte 3 (MSB)	byte 2	byte 1 (LSB)	red	green	blue	23		0
byte 3 (MSB)	byte 2	byte 1 (LSB)											
red	green	blue											
23		0											
This object is available only for groups and single devices in the "Colour" function range and in the "RGB combined" colour space.													

Function	Name	Type	DPT	Flag																				
Colour RGBW (value) - Status	Group 1...32 / Single device 1...64	6-byte	251.600	C, R, -, T, A																				
6-byte object for status indication of the currently set RGB light colour.																								
<table border="1" style="width:100%; text-align:center;"> <tr> <td>byte 6 (MSB)</td> <td>byte 5</td> <td>byte 4</td> <td>byte 3</td> <td>byte 2</td> <td colspan="3">byte 1 (LSB)</td> </tr> <tr> <td style="background-color:red; color:white;">red</td> <td style="background-color:green; color:white;">green</td> <td style="background-color:blue; color:white;">blue</td> <td>white</td> <td>unused</td> <td style="background-color:gray;"> </td> <td style="background-color:gray;"> </td> <td style="background-color:gray;"> </td> <td style="background-color:red; font-size:8px;">enable red</td> <td style="background-color:green; font-size:8px;">enable green</td> <td style="background-color:blue; font-size:8px;">enable blue</td> <td style="background-color:white; font-size:8px;">enable white</td> </tr> </table>					byte 6 (MSB)	byte 5	byte 4	byte 3	byte 2	byte 1 (LSB)			red	green	blue	white	unused				enable red	enable green	enable blue	enable white
byte 6 (MSB)	byte 5	byte 4	byte 3	byte 2	byte 1 (LSB)																			
red	green	blue	white	unused				enable red	enable green	enable blue	enable white													
47																								
0																								
This object is available only for groups and single devices in the "Colour" function range and "RGBW combined" colour space.																								

Function	Name	Type	DPT	Flag
Colour Red (value) - Status	Group 1...32 / Single device 1...64	1-byte	5.001	C, R, -, T, A
1-byte object for status indication of the currently set light colour red.				
This object is available only for groups and single devices within the "Colour" function range and in the "RGB individually" or "RGBW individually" colour space.				

Function	Name	Type	DPT	Flag
Colour Green (value) - Status	Group 1...32 / Single device 1...64	1-byte	5.001	C, R, -, T, A
1-byte object for status indication of the currently set light colour green.				
This object is available only for groups and single devices within the "Colour" function range and in the "RGB individually" or "RGBW individually" colour space.				

Function	Name	Type	DPT	Flag
Colour Blue (value) - Status	Group 1...32 / Single device 1...64	1-byte	5.001	C, R, -, T, A
1-byte object for status indication of the currently set light colour blue.				
This object is available only for groups and single devices within the "Colour" function range and in the "RGB individually" or "RGBW individually" colour space.				

Function	Name	Type	DPT	Flag
Colour white (value) - Status	Group 1...32 / Single device 1...64	1-byte	5.001	C, R, -, T, A
1-byte object for status indication of the currently set light colour white.				
This object is available only in the "RGBW individually" colour space.				
This object is available only for groups and single devices within the "Colour" function range and in the "RGBW individually" colour space.				

Function	Name	Type	DPT	Flag
Colour hue (H) - Status	Group 1...32 / Single device 1...64	1-byte	5.003	C, R, -, T, A
<p>1-byte object for status indication of the hue (H / 0...360°).</p> <p>This object is available only in the "HSV" or "HSVW" colour space.</p> <p>This object is available only for groups and single devices within the "Colour" function range and in the "HSV" or "HSVW" colour space.</p>				
Function	Name	Type	DPT	Flag
Saturation (S) - Status	Group 1...32 / Single device 1...64	1-byte	5.001	C, R, -, T, A
<p>1-byte object for indicating the status of the saturation (S / 0...100%).</p> <p>This object is available only for groups and single devices within the "Colour" function range and in the "HSV" or "HSVW" colour space.</p>				
Function	Name	Type	DPT	Flag
Brightness (V) - Status	Group 1...32 / Single device 1...64	1-byte	5.001	C, R, -, T, A
<p>1-byte object for status indication of the brightness value (V / 0...100%).</p> <p>This object is available only for groups and single devices within the "Colour" function range and in the "HSV" or "HSVW" colour space.</p>				
Function	Name	Type	DPT	Flag
White value (W) - Status	Group 1...32 / Single device 1...64	1-byte	5.001	C, R, -, T, A
<p>1-byte object for status indication of the white value (W / 0...100%).</p> <p>This object is available only for groups and single devices within the "Colour" function range and in the "HSVW" colour space.</p>				

9.7 Switch-on and switch-off behaviour

9.7.1 Switch-on and switch-off delays

Up to two time functions can be set independently of each other for each group and single device. The time functions apply only to the communication objects "Switching - Setting" or "Central function... - Switching" (if the central function is assigned to the group or single device) and delay the received object value depending on the telegram polarity.

To use the time delays, the "Time delays" parameter must be activated on the parameter page "DALI system... -> Configuration groups -> [x] Group name -> Enabled functions" or "DALI system... -> Configuration single devices -> [x] Device name -> Enabled functions".

- i** At the end of a disabling function or forced position function, the brightness state received during the function or adjusted before the function can be tracked. Residual times of time functions are also tracked if these had not yet fully elapsed at the time of the reactivation or forced control.
- i** The time delays do not influence the staircase function if this is enabled.
- i** A time delay still in progress will be fully aborted by a device reset (bus/mains voltage failure or ETS programming operation).

Activating switch-on delay

The switch-on delay can be activated separately in the ETS for each group and single device on the parameter page "DALI system... -> Configuration groups -> [x] Group name -> Time delays" or "DALI system... -> Configuration single devices -> [x] Device name -> Time delays".

The time delays must be enabled for the group or single device.

- Activate the parameter "switch-on delay".
The switch-on delay is activated. After receiving an ON telegram by means of the object "Switching - Setting" or "Central function... - Switching", the configurable time is started. Another ON telegram triggers the time only if the parameter "Retriggerable" is activated. An OFF-telegram received during the switch-on delay will end the delay and set the switching status to "OFF".

Activating switch-off delay

The switch-off delay can be activated separately in the ETS for each group and single device on the parameter page "DALI system... -> Configuration groups -> [x] Group name -> Time delays" or "DALI system... -> Configuration single devices -> [x] Device name -> Time delays".

The time delays must be enabled for the group or single device.

- Activate the parameter "Switch-off delay".

The switch-off delay is activated. After receiving an OFF telegram by means of the object "Switching - Setting" or "Central function... - Switching", the configurable time is started. Another OFF telegram triggers the time only if the "Retriggerable" parameter is activated. An ON-telegram received during the switch-off delay will end the delay and set the switching status to "ON".

9.7.2 Soft ON/OFF function

The soft-functions permit a group or a single device to be switched on or off at reduced speed if a switching command is received via the communication objects "Switching - Setting" or "Central function... - Switching". If the soft ON function is activated, a dimming procedure is executed until the switch-on brightness when switching on. This also occurs if the group or single device is already switched on to a brightness value lower than the switch-on brightness. Likewise, with the soft OFF function, a dimming process is executed to 0% brightness when receiving an OFF telegram.

The dimming speeds can be configured separately in the ETS for the soft ON and soft OFF function. Just as with relative or absolute dimming, the dimming step time is specified. The soft ON or soft OFF functions are not retriggerable by the receipt of further switching telegrams while maintaining the switching status.

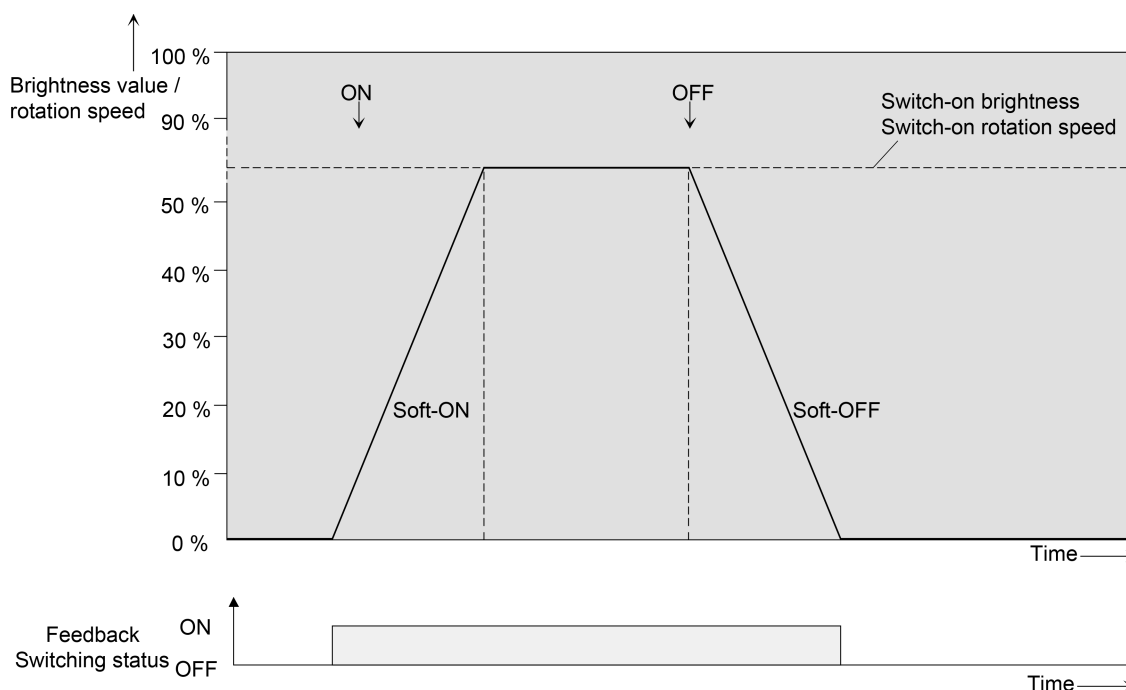

Figure 47: Dimming behaviour of the soft ON/OFF functions as an example with minimum brightness > 0%

To use the soft functions, the parameter "Switch-on/switch-off behaviour" must be activated on the parameter page "DALI system... -> Configuration groups -> [x] Group name -> Enabled functions" or "DALI system... -> Configuration single devices -> [x] Device name -> Enabled functions". The soft functions can then be configured separately for each group and single device on the parameter page "DALI system... ->

Configuration groups -> [x] Group name -> Switch-on/switch-off behaviour" or "DALI system... -> Configuration single devices -> [x] Device name -> Switch-on/switch-off behaviour".

- i** The dimming process for a soft ON function starts at the minimum brightness configured in the ETS. If a group or single device is switched off and then switched on, the operating devices jumping to the configured minimum brightness and start with the soft ON dimming process to the switch-on brightness.
- i** The soft functions also have effects on the switching edges of the staircase function.
- i** A group or individual disabled via the KNX can also flash depending on the ETS configuration for the disabling function. Dimming is not executed with the soft functions during ON and OFF flashing.

Activating and setting the soft ON function

In the ETS, the soft ON function can be activated separately for each group and single device on the parameter page "DALI system... -> Configuration groups -> [x] Group name -> Switch-on/switch-off behaviour" or "DALI system... -> Configuration single devices -> [x] Device name -> Switch on/off behaviour".

- Activate the "Soft ON function" parameter.
The soft ON function has been activated. The parameter for the dimming step time of the soft ON function becomes visible.
- Configure the parameter "Time between two dimming increments " to the necessary dimming step time.

Activating and setting the soft OFF function

In the ETS, the soft OFF function can be activated separately for each group and single device on the parameter page "DALI system... -> Configuration groups -> [x] Group name -> Switch-on/switch-off behaviour" or "DALI system... -> Configuration single devices -> [x] Device name -> Switch-on/switch-off behaviour".

- Activate the "Soft OFF function" parameter.
The soft OFF function has been activated. The parameter for the dimming step time of the soft OFF function becomes visible.
- Configure the parameter "Time between two dimming increments " to the necessary dimming step time.

9.7.3 Automatic switch-off

The switch-off function allows a group or single device to be automatically switched off after a brightness value was dimmed or jumped to and this new brightness value is below a switch-off brightness set in the ETS. A delay can be configured optionally until switching off.

The switch-off function is activated after reaching a constant brightness value, i. e. after a completed dimming procedure through absolute or relative dimming. A new dimming process, which ends below switch-off brightness starts, starts any time delay which may be present. In the same way, the switch-off function is interrupted if the switch-off brightness is exceeded during a dimming process.

The automatic switch-off function, for example, not only makes it possible to set the lighting to minimum brightness but to switch off by means of relative dimming as well. A further application, for example, is time-controlled "Good night switch-off" of a dimmed children's room lighting.

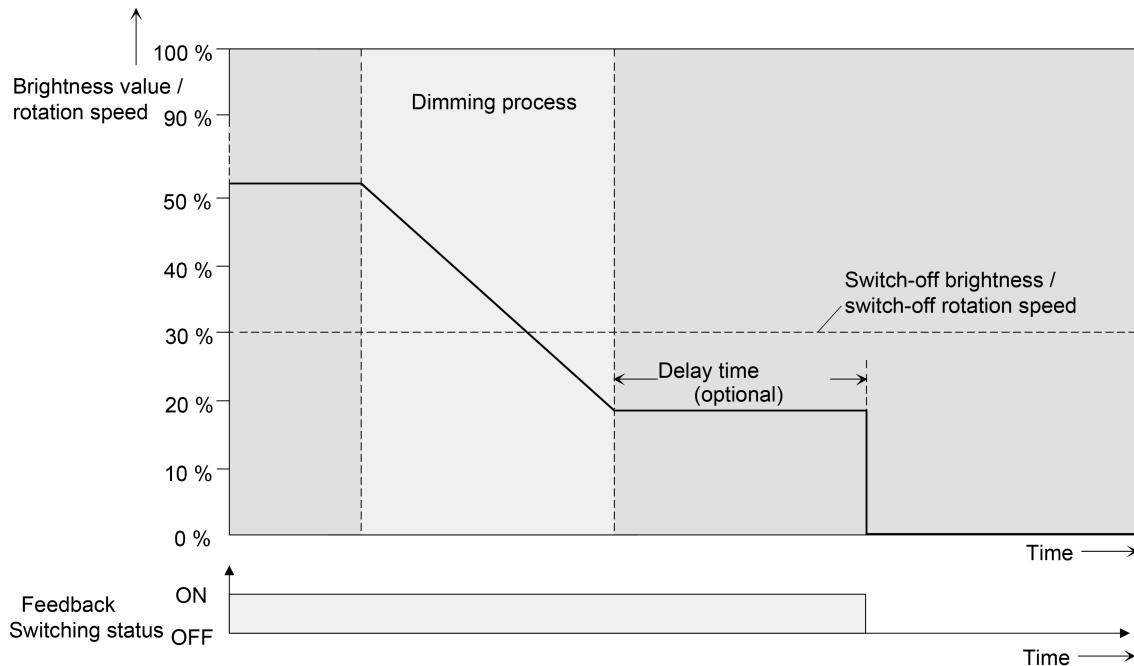

Figure 48: Dimming and switching behaviour of the automatic switch-off function

The switch-off function can also be combined with other functions of the gateway. It should be noted that the disabling function, the forced position function and the scene function override the switch-off function. The automatic switch-off can be activated only by a dimming process initiated by the communication objects for dimming (relative or absolute). If the switch-off function is overridden, the gateway terminates the processing of the delay time and the evaluation of the switch-off brightness.

Switching on via the communication object "Switching - Setting" or "Central function... - Switching" does not activate the switch-off function if the switch-on brightness is below the switch-off brightness and the switch-on brightness is jumped to directly. If a soft ON function is configured, the switch-on brightness is dimmed. In this case, the switch-off function is activated as soon as the switch-on brightness has been set to static. To prevent this, configure the switch-on brightness to be greater than the switch-off brightness.

To use the switch-off function, the "Switch-on/switch-off behaviour" parameter must be activated on the parameter page "DALI system... -> Configuration groups -> [x] Group name -> Enabled functions" or "DALI system... -> Configuration single devices -> [x] Device name -> Enabled functions".

- i** Switching off always takes place without soft OFF function, i. e. jumping.
- i** The status objects for the switching state and brightness value are updated by the automatic switch-off function after switching off.

Enabling automatic switch-off function

In the ETS, the automatic switch-off function can be activated separately for each group and single device on the parameter page "DALI system... -> Configuration groups -> [x] Group name -> Switch-on/switch-off behaviour" or "DALI system... -> Configuration single devices -> [x] Device name -> Switch on/off behaviour".

The switch on/off behaviour must be enabled for the group or single device.

- Activate the "Automatic switch-off" parameter.
The automatic switch-off function has been activated. Additional parameters become visible.

Setting the switch-off brightness

The switch-off brightness must be defined for the switch-off function. The switch-off brightness is set separately for each group and single device on the parameter page "DALI System... -> Configuration groups -> [x] Group name -> Switch-on/switch-off behaviour" or "DALI system... -> Configuration single devices -> [x] Device name -> Switch-on/switch-off behaviour".

The switch-on/switch-off behaviour and the switch-off function must be enabled for the group or single device.

- Set the parameter "Switch off if brightness value is smaller than" to the required brightness value.
As soon as a dimming process causes a value to fall below the configured switch-off brightness and the brightness has been set to constant, the group or single device switches off or alternatively starts the delay until switching off.

- i** The switch-off brightness in the dimmable brightness range must be set between the configured maximum and minimum brightness. Automatic switch-off does not take place if "Switch-off brightness = Minimum brightness" is set, since the switch-off brightness cannot be undershot. The switch-off function is always active if the switch-off brightness is configured to maximum brightness and the maximum brightness is undershot by dimming.

Setting the delay of the switch-off function

A time delay can be activated before the switch-off function switches-off automatically after undershooting the switch-off brightness at the end of a dimming procedure. The time delay can be optionally activated separately for each group and single device on the parameter page "DALI system... -> Configuration groups -> [x] Group name -> Switch-on/switch-off behaviour" or "DALI system... -> Configuration single devices -> [x] Device name -> Switch-on/switch-off behaviour".

The switch-on/switch-off behaviour and the switch-off function must be enabled for the group or single device.

- Activate the parameter "Delay until switch-off". Configure the parameter "Delay time" to the required time.

As soon as a dimming process causes a value to fall below the configured switch-off brightness and the brightness has been set to constant, the gateway triggers the delay time. The group or single device concerned switches off once the delay time has elapsed. The delay time can be re-triggered by further dimming procedures.

9.7.4 Parameters for switch-on/switch-off behaviour

DALI system... -> Configuration groups -> [x] Group name -> Enabled functions

DALI system... -> Configuration single devices -> [x] Device name -> Enabled functions

Time delays	Checkbox (yes/no)
Up to two time functions can be set independently of each other for each group and single device. The time functions apply only to the communication objects "Switching - Setting" or "Central function... - Switching" (if the central function is assigned to the group or single device) and delay the received object value depending on the telegram polarity.	
This parameter must be activated so that the time delays can be used.	

Switch-on/switch-off behaviour	Checkbox (yes/no)
The configurable switch-on/off behaviour includes the soft functions as well as the automatic switch-off function.	
The soft-functions permit a group or a single device to be switched on or off at reduced speed if a switching command is received via the communication objects "Switching - Setting" or "Central function... - Switching". If the soft ON function is activated, a dimming procedure is executed until the switch-on brightness when switching on. This also occurs if the group or single device is already switched on to a brightness value lower than the switch-on brightness. Likewise, with the soft OFF function, a dimming process is executed to 0% brightness when receiving an OFF telegram.	
The switch-off function allows a group or single device to be automatically switched off after a brightness value was dimmed or jumped to and this new brightness value is below a switch-off brightness set in the ETS. A delay can be configured optionally until switching off.	
This parameter must be activated so that the soft functions and the automatic switch-off function can be used.	

Parameters for the time delays

DALI system... -> Configuration groups -> [x] Group name -> Time delays

DALI system... -> Configuration single devices -> [x] Device name -> Time delays

Switch-on delay	Checkbox (yes/no)
This parameter activates the switch-on delay. After receiving an ON telegram by means of the object "Switching - Setting" or "Central function... - Switching", the configurable time is started. An OFF-telegram received during the switch-on delay will end the delay and set the switching status to "OFF".	
Delay time	0...59 min 0...10...59 s
This parameter defines the delay time for the switch-on delay. It is available only if the switch-on delay is enabled.	
Retriggerable	Checkbox (yes/no)
This parameter defines whether a running switch-on delay can be retriggered. It is available only if the switch-on delay is enabled. Another ON telegram retriggers the time only if this parameter is activated.	
Switch-off delay	Checkbox (yes/no)
This parameter activates the switch-off delay. After receiving an OFF telegram by means of the object "Switching - Setting" or "Central function... - Switching", the configurable time is started. An ON-telegram received during the switch-off delay will end the delay and set the switching status to "ON".	
Delay time	0...59 min 0...10...59 s
This parameter defines the delay time for the switch-off delay. It is available only if the switch-off delay is enabled.	
Retriggerable	Checkbox (yes/no)
This parameter defines whether a running switch-off delay can be retriggered. It is available only if the switch-off delay is enabled. Another OFF telegram retriggers the time only if this parameter is activated.	

Parameters for the soft functions

DALI system... -> Configuration groups -> [x] Group name -> Switch-on/switch-off behaviour

DALI system... -> Configuration single devices -> [x] Device name -> Switch-on/switch-off behaviour

Soft ON function	Checkbox (yes/no)
This parameter activates the soft ON function. If the soft ON function is activated, a dimming procedure is executed until the switch-on brightness when switching on.	

Time between two dimming increments	0...59 s 10...990 ms
This parameter defines the dimming speed for the soft ON function. It is available only if the soft ON function is enabled.	

Soft OFF function	Checkbox (yes/no)
This parameter activates the soft OFF function. With the soft OFF function activated, a dimming process is executed to 0% brightness after receiving an OFF telegram.	

Time between two dimming increments	0...59 s 10...990 ms
This parameter defines the dimming speed for the soft OFF function. It is available only if the soft OFF function is enabled.	

Parameters for the automatic switch-off function

DALI system... -> Configuration groups -> [x] Group name -> Switch-on/switch-off behaviour

DALI system... -> Configuration single devices -> [x] Device name -> Switch-on/switch-off behaviour

Automatic switch-off	Checkbox (yes/no)
This parameter activates the switch-off function. The switch-off function allows a group or single device to be automatically switched off after a brightness value was dimmed or jumped to and this new brightness value is below a switch-off brightness set in the ETS.	

Switch-off if brightness value smaller than	1%, 2%, 3%, 4%, 5% , 6%, 7%, 8%, 9%, 10%, 15%, 20%...50%...100%
---	--

The switch-off brightness must be defined for the switch-off function. As soon as a dimming process causes a value to fall below the configured switch-off brightness and the brightness has been set to constant, the group or single device switches off or alternatively starts the delay until switching off.

The switch-off brightness in the dimmable brightness range must be set between the configured maximum and minimum brightness. Automatic switch-off does not take place if "Switch-off brightness = Minimum brightness" is set, since the switch-off brightness cannot be undershot. The switch-off function is always active if the switch-off brightness is configured to maximum brightness and the maximum brightness is undershot by dimming.

This parameter is available only if the switch-off function is enabled.

Delay until switch-off	Checkbox (yes/no)
------------------------	-------------------

A time delay can be activated before the switch-off function switches-off automatically after undershooting the switch-off brightness at the end of a dimming procedure. If the function is activated, the gateway triggers the delay time as soon as the dimming process causes a value to fall below the configured switch-off brightness and the brightness has been set to constant. The group or single device concerned switches off once the delay time has elapsed. The delay time can be re-triggered by further dimming procedures.

This parameter is available only if the switch-off function is enabled.

Delay time	0...23 h 0...59 min 0... 30 ...59 s
------------	--

This parameter defines the delay time for the switch-off function. It is available only if the delay time is enabled.

9.8 Staircase function

The staircase function can be used for implementing time-controlled lighting of a staircase or for function-related applications. The staircase function must be enabled on the parameter page "DALI system... -> Configuration groups -> [x] Group name -> Enabled functions" or "DALI system... -> Configuration single devices -> [x] Device name -> Enabled functions" so that the required communication objects and parameters are available.

The staircase function is activated via the communication object "Staircase function - Start/Stop" and is independent of the "Switching - Setting" object. In this way, parallel operation of time control and normal control is possible, whereby the last command received is always executed. A telegram on the object "Switching - Setting" at the time of an active staircase function aborts the staircase time prematurely and sets the switching state according to the received object value (the time delays are also taken into account). Likewise, the switching state of the object "Switching - Setting" can be overridden by a staircase function.

Time-independent continuous light switching can also be implemented in combination with a disabling function because the disabling function has a higher priority and overrides the switching state of the staircase function.

The staircase function can be extended by means of a supplementary function. At the same time, it is possible to activate a time extension. The "time extension" permits retriggering of an activated staircase via the object "Staircase function - Start/Stop" n times. Alternatively, the "time preset via the bus" can be set. With this supplementary function, the configured staircase time can be multiplied by a factor received via the bus, thus it can be adapted dynamically.

Furthermore, an extension of the staircase function can be implemented by means of a pre-warning function. During the pre-warning, the brightness can be reduced. The pre-warning should warn people in the staircase that the light will soon be switched off. As an alternative to the pre-warning at the end of the staircase time, the gateway can activate reduced continuous lighting. In this way, for example, long, dark hallways can have permanent basic lighting.

- i** The staircase function influences only the brightness of a group or single device. The colour temperature or colour is not affected by the staircase function.

Specifying switch-on behaviour of the staircase function

An ON telegram to the "Staircase function - Start/Stop" object activates the staircase time (T_{ON}), the duration of which is defined by the "Staircase time" parameters. The group or single device switches to the switch-on brightness. At the end of the staircase time, the group or single device shows the "at the end of the staircase time" configured in the ETS. At the same time, the group or single device can switch off, optionally activate the pre-warning time ($T_{prewarn}$) of the pre-warning function or dim to the reduced continuous lighting (application: e. g. long, dark hallways). Taking into account a possible pre-warning function, this gives rise to the example switch-on behaviour of the staircase function.

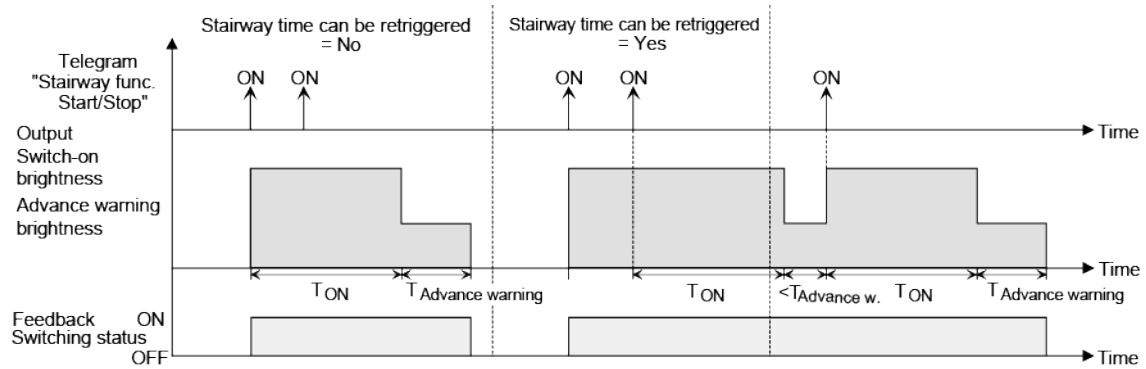

Figure 49: Switch-on behaviour of the staircase function without soft functions

In addition, switching on can be influenced by the soft functions of the gateway. Taking into account a soft ON and soft OFF function, this gives rise to the switch-on behaviour of the staircase function shown below.

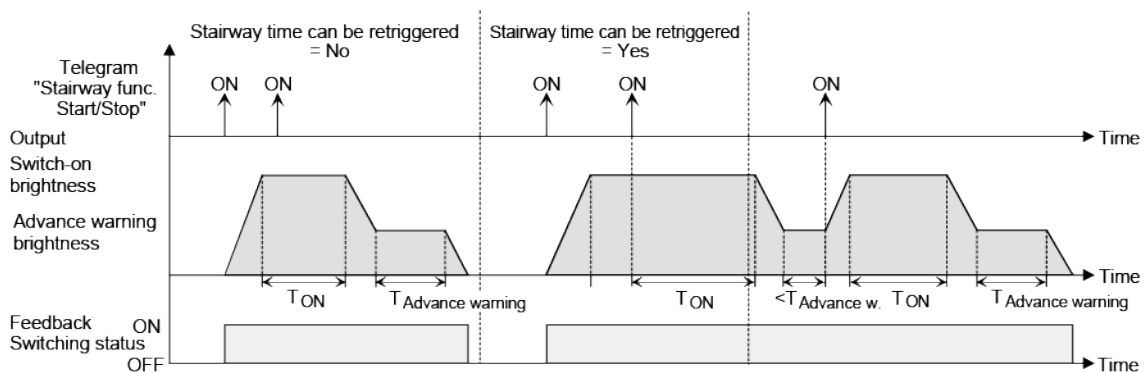

Figure 50: Switch-on behaviour of the staircase function with soft functions (as an example with minimum brightness = 0 %)

- Activate the "Staircase function" parameter on the parameter page "DALI system... -> Configuration groups -> [x] Group name -> Enabled functions" or "DALI system... -> Configuration single devices -> [x] Device name -> Enabled functions".

The staircase function is enabled. The parameter page "DALI system... -> Configuration groups -> [x] Group name -> Staircase function" or "DALI system... -> Configuration single devices -> [x] Device name -> Staircase function" and other parameters become visible.

The staircase function must be enabled.

- In the "Staircase time" parameter, configure the necessary switch-on time of the staircase function.
- Activate the "Retriggerable" parameter.
Every ON telegram received during the ON phase of the staircase time retrigger the staircase time completely.
- Alternatively, deactivate the "Retriggerable" parameter.
ON telegrams received during the ON phase of the staircase time are rejected. The staircase time is not retriggered.

- i** An ON telegram received during the pre-warning time or during the reduced continuous lighting always subsequently triggers the staircase time independently of the "Retriggerable" parameter.

Setting the switch-on delay of the staircase function

An ON telegram for activation of the staircase function can also be evaluated with a time delay. This switch-on delay can be activated separately for the staircase function and has no influence on the configurable time delays for the object "Switching - Setting".

The staircase function must be enabled.

- On the parameter page "DALI system... -> Configuration groups -> [x] Group name -> Staircase function" or "DALI system... -> Configuration single devices -> [x] Device name -> Staircase function", deactivate the "Switch-on delay" parameter.

The switch-on delay is deactivated. After receiving an ON telegram on the object "Staircase function - Start/Stop", the staircase time is activated immediately.

- Activate the parameter "switch-on delay".

The switch-on delay has been activated for the staircase function. The desired switch-on delay time can be specified. After receipt of an ON telegram on the object "Staircase function - Start/Stop", the switch-on delay is started. Another ON-telegram triggers the time only when the parameter "Switch-on delay retriggerable" is activated. The staircase time is activated only after the time delay has elapsed.

- i** An OFF telegram via the object "Staircase function - Start/Stop" during the switch-on delay only terminates the delay if the parameter "Reaction to OFF-telegram" is set to "switch off". Otherwise, the OFF telegram is ignored.

- i** When the supplementary function "Time extension" is preset, the parameter "Switch-on delay retriggerable" cannot be adjusted. In this case, it is permanently deactivated.

Specifying switch-off behaviour of the staircase function

In the case of a staircase function, the reaction to an OFF telegram can also be configured to the object "Staircase function - Start/Stop". Without receiving an OFF telegram, the group or single device always shows the "at the end of the staircase time" configured in the ETS at the end of the staircase time. At the same time, the group or single device can switch off, optionally activate the pre-warning time (T_{prewarn}) of the pre-warning function or dim to the reduced continuous lighting (application: e. g. long, dark hallways).

If, on the other hand, the group or single device receives an OFF telegram via the object "Staircase function - Start/Stop", the gateway evaluates the parameter "Reaction to an OFF-telegram". In this case, the group or single device can react immediately

to the OFF telegram and end the staircase time prematurely. Alternatively, the OFF telegram can be ignored. Taking into account any possible pre-warning function, this gives rise to the example switch-off behaviour of the staircase function .

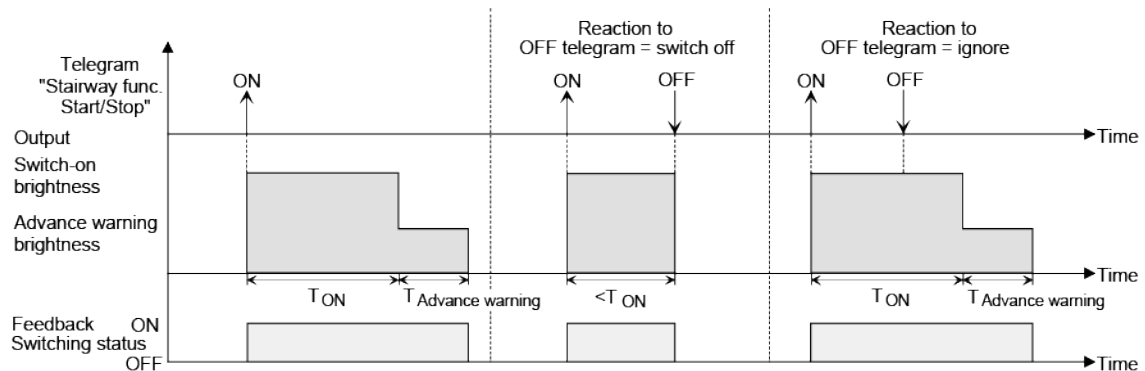

Figure 51: Switch-off behaviour of the staircase function without soft functions

In addition, switching off can be influenced by the soft functions of the gateway. Taking into account a soft ON and soft OFF function, this gives rise to the switch-off behaviour of the staircase function shown below.

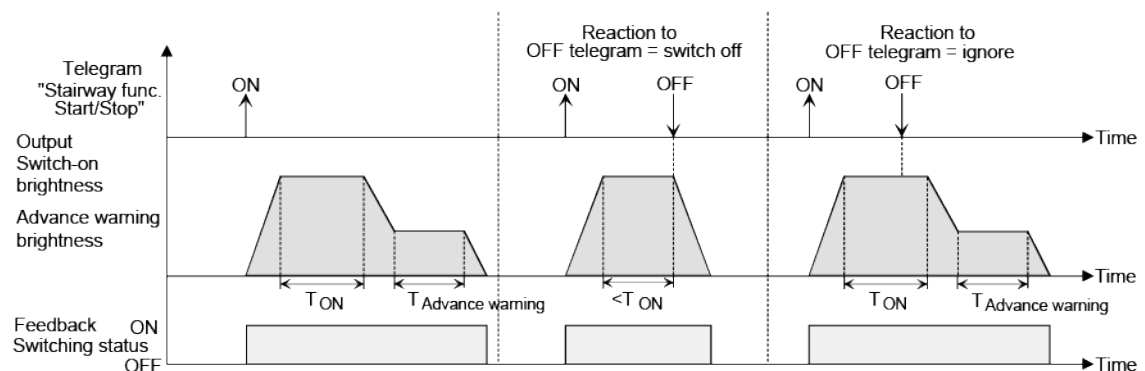

Figure 52: Switch-off behaviour of the staircase function with soft functions (as an example with minimum brightness = 0 %)

The parameter "Reaction to OFF-telegram" defines whether the staircase time (T_{ON}) of the staircase function can be aborted prematurely. This parameter can be found on the parameter page "DALI system... -> Configuration groups -> [x] Group name -> Staircase function" or "DALI system... -> Configuration single devices -> [x] Device name -> Staircase function" and applies exclusively to the object "Staircase function - Start/Stop".

The staircase function must be enabled.

- Set parameter "Reaction to OFF-telegram" to "switch off".

Once an OFF telegram is received via the object "Staircase function - Start/Stop" during the ON phase of the staircase time, the operating devices switch off immediately. If the staircase time is stopped prematurely by such a telegram, there is no pre-warning, i. e. the pre-warning time is not started. It is also not dimmed to a reduced continuous lighting. It is also possible to switch off prematurely during a dimming process of a soft function or during a pre-warning or reduced continuous lighting.

- Set parameter "Reaction to OFF-telegram" to ignore".
 OFF telegrams received via the object "Staircase function - Start/Stop" during the ON phase of the staircase function are rejected. The staircase time is executed completely to the end with the configured "at the end of the staircase time".

Setting the pre-warning function of the staircase function

At the end of the switch-on time of the staircase function, the group or single device shows the "at the end of the staircase time" configured in the ETS. The group or single device can be set to switch off immediately, alternatively to dim to the reduced continuous lighting (application: e.g. long, dark hallways) or to execute the pre-warning function. If the parameter is configured to "activate pre-warning time", the pre-warning time (T_{Prewarn}) and pre-warning brightness can be configured in the ETS.

The pre-warning should warn people still on the staircase that the light will soon be switched off. As a pre-warning, the operating devices can be set to a reduced brightness (pre-warning brightness) before they switch off permanently. The pre-warning brightness is normally reduced in the brightness value compared to the switch-on brightness. The pre-warning time (T_{prewarn}) and the pre-warning brightness can be configured separately. The pre-warning time is added to the staircase time (T_{ON}). The pre-warning time influences the values of the status objects so that the switching state "OFF" and the value "0" are not tracked in the objects until the pre-warning time has elapsed.

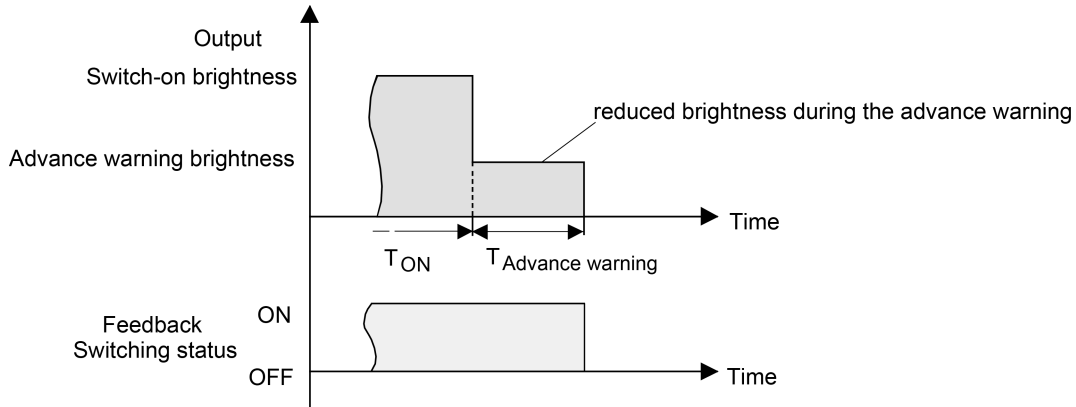

Figure 53: The pre-warning function of the staircase function without soft OFF function

Additionally, the pre-warning function can also be extended by the soft OFF function. Taking into account a soft OFF function, this gives rise to the switch-off behaviour of the staircase function shown below after the pre-warning has elapsed.

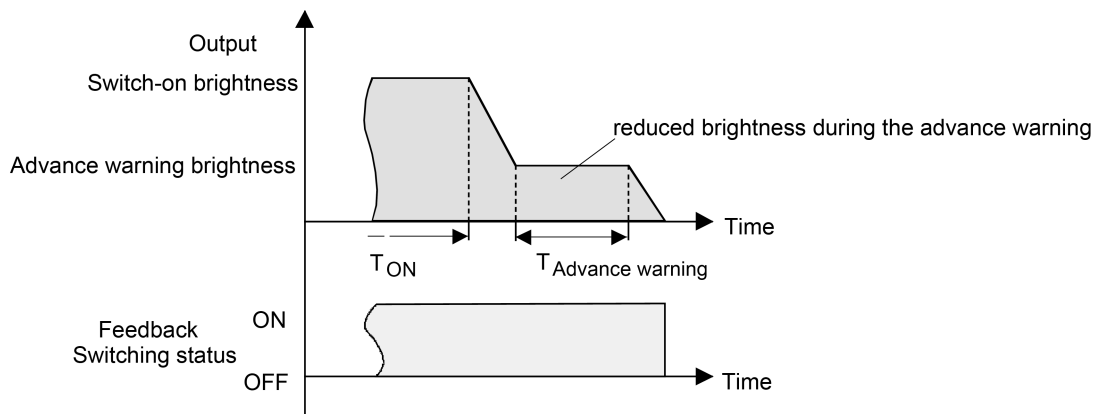

Figure 54: The pre-warning function of the staircase function with soft OFF function (as an example with minimum brightness = 0%)

- i** The pre-warning brightness does not necessarily have to be less than the switch-on brightness. The pre-warning brightness can always be configured to values between maximum brightness and minimum brightness.

The staircase function must be enabled.

- On the parameter page "DALI system... -> Configuration groups -> [x] Group name -> Staircase function" or "DALI system... -> Configuration single devices -> [x] Device name -> Staircase function", set the parameter "At the end of the staircase time" to "Activate pre-warning time".

The pre-warning function is enabled. The desired pre-warning time ($T_{Prewarn}$) can be preset.

- Configure the "pre-warning time".
- Set the parameter "Reduced brightness" to the desired brightness value.

During the pre-warning time, the group or single device is set to the configured brightness value.

- i** An ON telegram on the object "Staircase function - Start/Stop" while a pre-warning function is in progress stops the pre-warning time and always restarts (independently of the "Retriggerable" parameter) the staircase time again. Even during the pre-warning time, the parameter "reaction to OFF telegram" is evaluated so that a pre-warning in progress can be terminated early by switching off.

- i** Using the automatic switch-off function: The reduced brightness of the pre-warning does not start the switch-off function after reaching or undershooting the switch-off brightness!

Setting continuous lighting of the staircase function

At the end of the switch-on time of the staircase function, the gateway shows the configured behaviour "at the end of the staircase time" for the group concerned or the single device. It can be set that the group or single device switches off immediately, alternatively executes a pre-warning function or dims to the reduced continuous lighting. The reduction of the lighting to continuous lighting after the staircase time has

elapsed is appropriate, for example, if a certain degree of artificial light should be switched on permanently in long, dark hallways. Switching to switch-on brightness by activating the staircase function normally takes place by additional presence detectors or motion detectors when people are present in the hallway.

If the parameter "At the end of the staircase time" is configured to "activate reduced continuous lighting", the brightness for the continuous lighting can be configured. The continuous brightness is normally reduced in the brightness value compared to the switch-on brightness.

The continuous lighting remains permanently active after the staircase time has elapsed. Only when an ON telegram is received again via the object "Staircase function - Start/Stop" does the gateway switch back to the switch-on brightness and start counting the staircase time again. The receipt of an OFF telegram via the object "Staircase function - Start/Stop" switches the continuous lighting off only if the parameter "Reaction to OFF-telegram" is configured to "Switch-off".

- i** A group or single device can always be switched on and off via the object "Switching - Setting", independently of the staircase function. Consequently, continuous lighting will also be overridden if telegrams arrive via this object. If permanent continuous lighting is desired, which cannot be influenced by the object "Switching - Setting" nor by the object of the staircase function, the disabling function should be used.

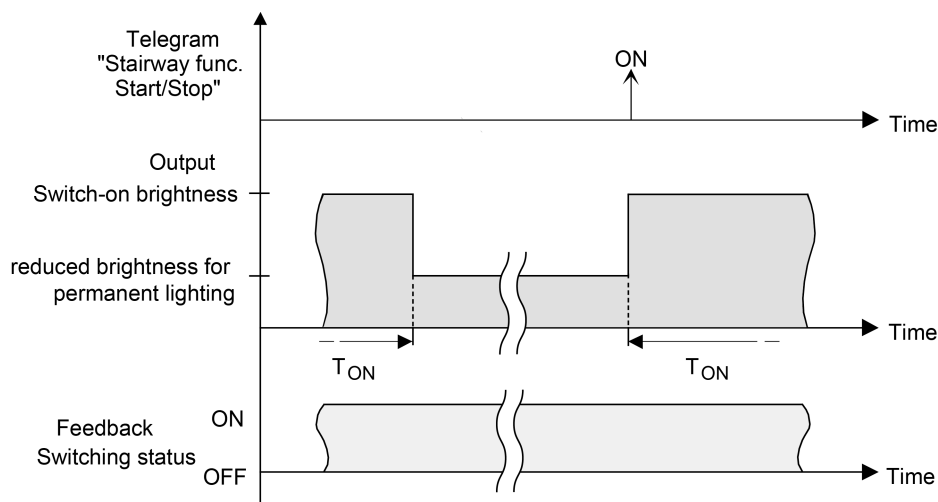

Figure 55: The continuous lighting of the staircase function without soft functions

Additionally, the continuous lighting can also be extended by the soft function. Taking into account any soft ON and soft OFF function, this gives rise to modified continuous lighting behaviour of the staircase function.

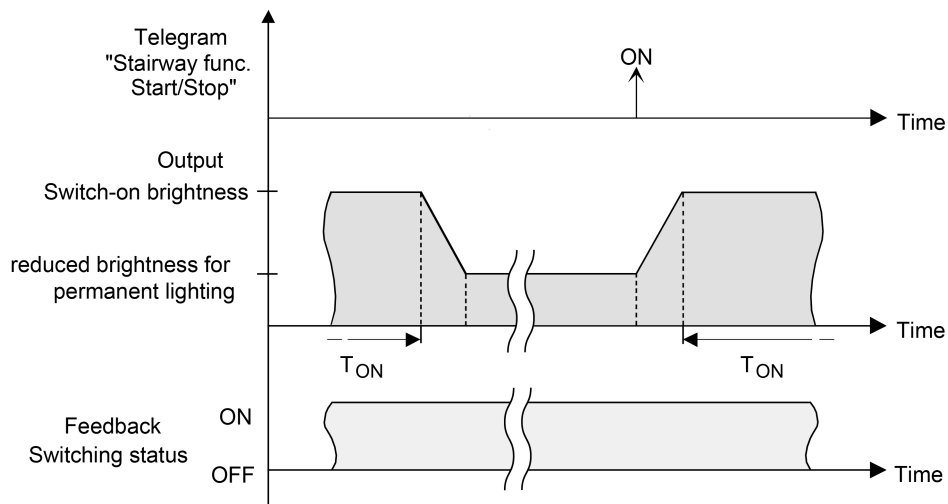

Figure 56: The continuous lighting of the staircase function with soft OFF functions

- i** The brightness of the continuous lighting does not necessarily have to be less than the switch-on brightness. The brightness of the continuous lighting can always be configured to values between minimum brightness and maximum brightness.

The staircase function must be enabled.

- On the parameter page "DALI system... -> Configuration groups -> [x] Group name -> Staircase function" or "DALI system... -> Configuration single devices -> [x] Device name -> Staircase function", set the parameter "At the end of the staircase time" to "Activate reduced continuous lighting".

The continuous lighting is enabled. The "Reduced brightness" can be set to the desired brightness value.

- i** The configured value for the reduced brightness must be greater than or equal the minimum brightness or less than or equal the maximum brightness!
- i** An ON telegram on the object "Staircase function - Start/Stop" always restarts (independently of the "Retriggerable" parameter). Even during activated continuous lighting, the parameter "Reaction to OFF telegram" is evaluated so that continuous lighting can be switched off.
- i** Using the automatic switch-off function: The reduced brightness of the continuous lighting does not start the switch-off function after reaching or undershooting the switch-off brightness!

Setting supplementary function of the staircase function – time extension

With the time extension function, the staircase time can be retriggered several times, i. e. extended, via the "Staircase function - Start/Stop" object. The duration of the extension is predefined by several operations at the control section (several ON telegrams in succession). The configured staircase time can be extended in this way within a time period by a maximum of the configured factor (a maximum of 5-fold). The time is always extended automatically at the end of a single staircase time (T_{ON}).

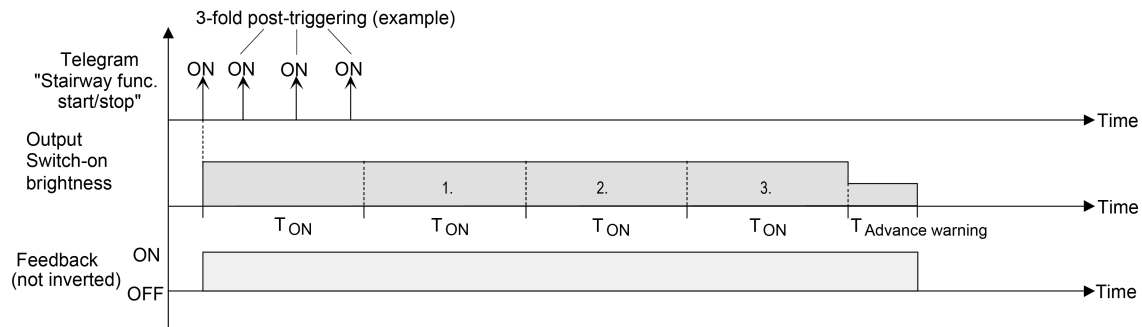

Figure 57: Time extension of the staircase function

With this function, the duration of a switched on light in a staircase can be extended (e.g. by a person after shopping) by a defined length of time without having to retrigger the switch-on time of the lighting every time the lighting shuts off automatically.

- Set the parameter "Supplementary function" to "time extension" and set the maximum desired factor in the "maximum time extension" parameter.

Each time an ON telegram is received on the object "Staircase function - Start/Stop", the staircase time is extended automatically by retriggering after it has elapsed. The number of telegrams received determines how often the staircase time is retriggered. The retriggering within the period of a staircase time (T_{ON}) can occur only as often as specified by the configured factor. For example, the "3-fold time" setting means that after the started staircase time has elapsed and within the current retriggered time period, it is retriggered automatically a maximum of three additional times.

- i** A time extension can generally be triggered during the entire switch-on time. In each period of an extended staircase time, new extensions can take place by telegrams. The "Maximum time extension" parameter is re-evaluated in each new time period.
- i** Telegrams for the time extension are only evaluated during the staircase time. An ON telegram during the pre-warning function or continuous lighting triggers the staircase time as a restart, which means that a new time extension is possible.
- i** If a time extension has been configured as a supplementary function, the "Retriggerable" parameter is permanently set to "No" because the retriggering is carried out by the time extension.

Setting supplementary function of the staircase function – time preset via the bus

With the time preset via the bus, the configured staircase time can be multiplied by an 8-bit factor received via the bus, thus it can be adapted dynamically. In this setting, the factor is derived from the object "Staircase time - Factor". The possible factor value for setting the staircase time is between 1...255.

The entire staircase time arises as a product from factor (object value) and the configured staircase time as a basis as follows...

$$\text{Staircase time} = (\text{staircase time object value}) \times (\text{staircase time parameter})$$

Example:

Object value "staircase time factor" = 5; parameter "staircase value" = 10s.

-> set staircase time = 5 x 10s = 50 s

Alternatively, the staircase function parameter can define whether the receipt of a new factor also starts the staircase time of the staircase function at the same time. In this case, the object "Staircase function - Start/Stop" is not necessary and the received factor value determines the starting and stopping.

- Set the "Supplementary function" parameter to "time preset via the bus" and deactivate the parameter "staircase function activatable via 'staircase time' object".

The staircase time can be adapted dynamically by the object "Staircase time - Factor". The value "0" is interpreted as the value "1". The staircase function is started and stopped exclusively via the "Staircase function - Start/Stop" object.

- Set the parameter "supplementary function for staircase function" to "time preset via the bus" and activate the parameter "staircase function activatable via 'staircase time' object".

The staircase time can be adapted dynamically by the object "Staircase time - Factor". In addition, the staircase function is started with the new staircase time (the object "Staircase function - Start/Stop" is not necessary). The factor value "0" is interpreted as an OFF telegram, whereby in this case, the configured reaction to an OFF telegram is evaluated, too.

A larger staircase with several floors is an example as an application for the time preset via the bus with automatic starting of the staircase time. On each floor there is a push-button sensor that transmits a factor value to the staircase function. The higher the floor, the greater the factor value transmitted so that the lighting stays switched on longer if the passing through the staircase needs more time. When a person enters a staircase and a pushbutton is pressed, the staircase time is now adjusted dynamically to the staircase time and switches on the lighting at the same time, too.

- A factor > 0 received during a warning time triggers the staircase time independently of the "Retriggerable" parameter.

- i** After a reset (bus voltage return or ETS programming operation) the object "Staircase time - Factor" is always initialised with "1". The staircase function is not started automatically solely as the result of this, however.

Presetting behaviour of the staircase function after bus or mains voltage return

The staircase function can be started automatically after bus or mains voltage return.

The staircase function must be enabled.

- On the parameter page "DALI system... -> Configuration groups -> [x] Group name" or "DALI system... -> Configuration single devices -> [x] Device name", set the parameter "After bus/mains voltage return" to "Start staircase function".

Immediately after bus or mains voltage return, the staircase time of the staircase function is started.

- i** The configured behaviour will only be executed, if no forced position on bus voltage return is activated.

9.8.1 Parameters for staircase function

DALI system... -> Configuration groups -> [x] Group name -> Enabled functions

DALI system... -> Configuration single devices -> [x] Device name -> Enabled functions

Staircase function	Checkbox (yes/no)
The staircase function can be used for implementing time-controlled lighting of a staircase or for function-related applications.	
This parameter must be activated so that the staircase function can be used.	

DALI system... -> Configuration groups -> [x] Group name -> Staircase function

DALI system... -> Configuration single devices -> [x] Device name -> Staircase function

Staircase time	0...23 h 0...3...59 min 0...59 s
The duration of the switch-on time for the staircase function is configured here.	

Retriggerable	Checkbox (yes/no)
The staircase time can be retriggered if necessary.	
Activated: Every ON telegram received during the ON phase of the staircase time re-triggers the staircase time completely.	
Deactivated: ON telegrams received during the ON phase of the staircase time are rejected. The staircase time is not retriggered.	
An ON telegram received during the pre-warning time or during the reduced continuous lighting always subsequently triggers the staircase time independently of the "Retriggerable" parameter. If a time extension has been configured as a supplementary function, the "Retriggerable" parameter is permanently set to "No" because the retriggering is carried out by the time extension.	

Switch-on delay	Checkbox (yes/no)
<p>An ON telegram for activation of the staircase function can also be evaluated with a time delay. This parameter activates the switch-on delay of the staircase function if required.</p> <p>Activated: The switch-on delay has been deactivated for the staircase function. The desired switch-on delay time can be specified. After receipt of an ON telegram on the object "Staircase function - Start/Stop", the switch-on delay is started. Another ON-telegram triggers the time only when the parameter "Switch-on delay retriggerable" is activated. The staircase time is activated only after the time delay has elapsed.</p> <p>Deactivated: The switch-on delay is deactivated. After receipt of an ON telegram on the object "Staircase function - Start/Stop", the staircase time is activated immediately and the output switched on.</p>	

Switch-on delay	0...23 h 0...59 min 0...30...59 s
<p>The time of the switch-on delay is configured here. The staircase time is activated only after the time delay has elapsed.</p> <p>This parameter is available only if the switch-on delay of the staircase function is enabled.</p>	

Switch-on delay retriggerable	Checkbox (yes/no)
<p>An ON telegram for activation of the staircase function can also be evaluated with a time delay. This parameter activates the switch-on delay of the staircase function if required.</p> <p>Activated: The switch-on delay has been deactivated for the staircase function. The desired switch-on delay time can be specified. After receipt of an ON telegram on the object "Staircase function - Start/Stop", the switch-on delay is started. Another ON-telegram triggers the time only when the parameter "Switch-on delay retriggerable" is activated. The staircase time is activated and the output is switched on only after the time delay has elapsed.</p> <p>Deactivated: The switch-on delay is deactivated. After receipt of an ON telegram on the object "Staircase function - Start/Stop", the staircase time is activated immediately and the output switched on.</p> <p>This parameter cannot be adjusted if the "Time extension" supplementary function is set. In this case, it is permanently deactivated.</p> <p>This parameter is available only if the switch-on delay of the staircase function is enabled.</p>	

Reaction to OFF-telegram	Switch-off ignore
<p>In the event of a staircase function, the reaction to an OFF telegram to the object "Staircase function - Start/Stop" can also be set with this parameter.</p> <p>Switch-off: Once an OFF telegram is received via the object "Staircase function - Start/Stop" during the ON phase of the staircase time, the operating devices switch off immediately. If the staircase time is stopped prematurely by such a telegram, there is no pre-warning, i. e. the pre-warning time is not started. It is also not dimmed to a reduced continuous lighting. It is also possible to switch off prematurely during a dimming process of a soft function or during a pre-warning or reduced continuous lighting.</p> <p>Ignore: OFF telegrams received via the object "Staircase function - Start/Stop" during the ON phase of the staircase function are rejected. The staircase time is executed completely to the end with the configured "at the end of the staircase time".</p>	
Supplementary function	no supplementary function Time extension Time preset via the bus
<p>The staircase function can be extended by means of a supplementary function.</p> <p>Time extension: The staircase time can be retriggered several times, i. e. extended by means of the time extension. The duration of the extension is predefined by several operations at the control section (several ON telegrams in succession). The configured staircase time can be extended in this way within a time period by a maximum of the configured factor (a maximum of 5-fold). The time is then always extended automatically at the end of a single staircase time.</p> <p>Each time an ON telegram is received on the object "Staircase function - Start/Stop", the staircase time is extended automatically by retriggering after it has elapsed. The number of telegrams received determines how often the staircase time is retriggered. The retriggering within the period of a staircase time (TON) can occur only as often as specified by the configured factor.</p> <p>Time preset via the bus: With the time preset via the bus, the configured staircase time can be multiplied by an 8-bit factor received via the bus, thus it can be adapted dynamically. In this setting, the factor is derived from the object "Staircase time - Factor".</p>	

Maximum time extension	1-fold staircase time 2-fold staircase time 3-fold staircase time 4-fold staircase time 5-fold staircase time
<p>The configured staircase time can be extended within a time period by a maximum of the factor configured here. The time is then always extended automatically at the end of a single staircase time. The retriggering within the period of a staircase time can only occur as often as the configured factor specifies.</p> <p>This parameter is available only with "supplementary function = time extension".</p>	
Staircase function activatable via "Staircase time" object	Checkbox (yes/no)
<p>At this point it can be defined whether the reception of a new factor also starts the staircase time of the staircase function at the same time. In this case, the object "Staircase function - Start/Stop" is not necessary and the received factor value determines the starting and stopping.</p> <p>Activated: The staircase time can be adapted dynamically by the object "Staircase time - Factor". In addition, the staircase function is started with the new staircase time (the object "Staircase function - Start/Stop" is not necessary). The factor value "0" is interpreted as an OFF telegram, whereby in this case, the configured reaction to an OFF telegram is evaluated, too.</p> <p>Deactivated: The staircase time can be adapted dynamically by the object "Staircase time - Factor". The value "0" is interpreted as the value "1". The staircase function is started and stopped exclusively via the "Staircase function - Start/Stop" object.</p> <p>This parameter is available only with "supplementary function = time preset via the bus".</p>	
At the end of staircase time	Switch-off Activate pre-warning time activate reduced continuous lighting
<p>At the end of the switch-on time of the staircase function, the group or single device behaves as configured here. The group or single device can be set to switch off immediately, alternatively to dim to the reduced continuous lighting (application: e.g. long, dark hallways) or to execute the pre-warning function.</p>	
Pre-warning time	0...59 min 0... 30 ...59 s
<p>This parameter is used for setting the duration of the pre-warning time. The pre-warning time is added to the switch-on time. The reduced brightness is set during the time configured here.</p> <p>This parameter is visible only with activated pre-warning time.</p>	

Reduced brightness	1%, 2%, 3%, 4%, 5%, 6%, 7%, 8%, 9%, 10%, 15%, 20%...50%...100%
<p>This parameter defines the reduced brightness that is set for pre-warning or continuous lighting.</p> <p>This parameter is visible only with activated pre-warning time or continuously lighting.</p>	

9.8.2 Objects for staircase function

Function	Name	Type	DPT	Flag
Staircase function - Start/Stop	Group 1...32 / Single device 1...64	1-bit	1.010	C, -, W, -, U
1-bit object to activate or deactivate the switch-on time of the staircase function ("1" = switch-on / "0" = switch-off).				
Function	Name	Type	DPT	Flag
Staircase time - Factor	Group 1...32 / Single device 1...64	1-byte	5.010	C, -, W, -, U
1-byte object to specify a time factor for the switch-on time of the staircase function (value range: 0...255).				

9.9 Operating hours counter

The operating hours counter determines the switch-on time of a group or single device. A group or single device is switched on for the operating hours counter if the brightness value is greater than "0", i. e. when the lamp is lit up. The operating hours counter can either be configured as a second counter or alternatively as an hour counter.

- Second counter
The gateway adds the determined switch-on time for a group or single device to the second. The totalled operating seconds are added in a 4-byte counter and stored permanently in the gateway. The current counter reading can be transmitted cyclically to the KNX by the "Operating hours counter - Counter reading - Status" communication object or when there is a change in an interval value in accordance with DPT 13.100.
- Hour counter
The gateway adds up the determined switch-on time for a group or single device to full operating hours to the minute. The totalled operating hours are added in a 2-byte counter and stored permanently in the device. The current counter reading can be transmitted cyclically to the KNX by the "Operating hours counter - Counter reading - Status" communication object or when there is a change in an interval value in accordance with DPT 7.007.

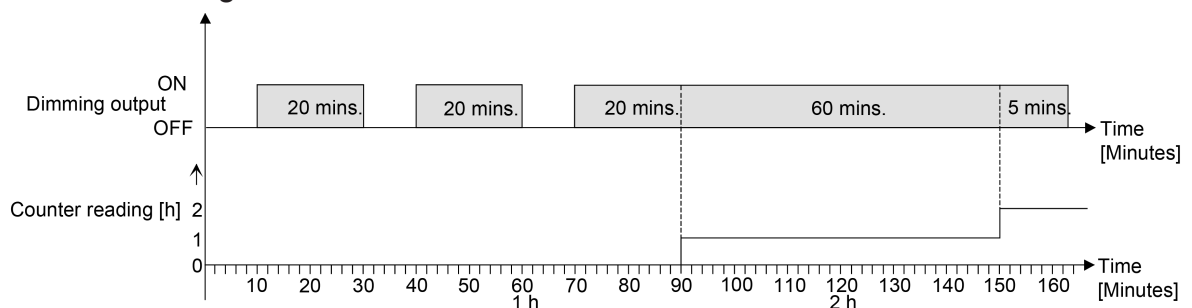

Figure 58: Function of the operating hours counter (using the example of counted hours)

In the delivery state, all values of the gateway are set to "0". If the operating hours counter is not enabled in the configuration of a group or single device, no operating hours or operating seconds are counted. Once the operating hours counter is enabled in the ETS, however, the operating hours or operating seconds are determined and added up by the ETS immediately after commissioning the gateway. If an operating hours counter is subsequently disabled again in the parameters and the gateway is programmed with this disabling function, all operating hours or seconds previously counted for the group or the single device concerned are deleted. When enabled again, the counter reading of the operating hours counter is always set to "0".

The operating hour values (full hours) or operating seconds stored in the device are not lost in the event of a bus/mains voltage failure or due to an ETS programming operation. On the hour counter: Any summed up operating minutes (full hour not yet reached) will be rejected in this case, however.

After the bus or mains voltage returns or after an ETS programming operation, the gateway updates the communication object "Operating hours counter - Counter reading" for each group and single device and actively transmits the object value to the KNX. The object value can also be read out at any time with the read flag set.

Activating the operating hours counter

- Activate the "Operating hours counter" parameter on the parameter page "DALI system... -> Configuration groups -> [x] Group name -> Enabled functions" or "DALI system... -> Configuration single devices -> [x] Device name -> Enabled functions".

The operating hours counter is activated.

- Deactivate the operating hours counter".

The operating hours counter is deactivated.

-  Disabling of the operating hours counter and subsequent programming with the ETS resets the counter status to "0".

Setting the counter type

The operating hours counter can optionally be configured as an up-counter or down-counter. Depending on this type of counter, a limit or start value can be set optionally, whereby, for example, the operating time of a lamp can be monitored by restricting the counter range.

Up-counter:

After activating the operating hours counter by enabling in the ETS or by restarting, the operating hours are counted starting at "0". A maximum of 65,535 hours or 2,147,483,647 seconds can be counted (corresponds to approx. 66 years). After that the counter stops and signals a counter operation via the object "Operating hours counter - Counter reading elapsed - Status".

A limit value can be optionally set in the ETS or specified via the communication object "Operating hours counter - Signal value". In this case, the counter operation is signalled to the KNX via the "Operating hours counter - Counter reading elapsed - Status" object if the signal value is reached, but the counter continues counting - if it is not restarted - up to the maximum value and then stops. Only a restart initiates a new counting operation.

Down-counter:

After enabling the operating hours counter in the ETS, the counter reading is set to "0" and the gateway signals a counter operation for the group concerned or the single device after the programming operation or after the bus voltage returns via the object "Operating hours counter - Counter reading elapsed - Status". Only after a restart is the down-counter set to the maximum value of 65,535 hours or 2,147,483,647 seconds (corresponds to approx. 66 years) and the counter operation is started.

A start value can optionally be set in the ETS or specified via the communication object "Operating hours counter - Start value". If a start value is set, the down-counter is initialised with this value instead of the maximum value after a restart. The counter then counts the start value downwards by the hour. When the down-counter reaches

the value "0", the counter operation is signalled to the KNX via the object "Operating hours counter - Counter reading elapsed - Status" and counting is stopped. Only a restart initiates a new counting operation.

The operating hours counter must be enabled.

- Set the "Counting direction" parameter on the parameter page "DALI system... -> Configuration groups -> [x] Group name -> Operating hours counter" or "DALI system... -> Configuration single devices -> [x] Device name -> Operating hours counter" to "Forward". Activate the parameter "Specify signal value" if monitoring of a signal value is necessary. Otherwise deactivate the parameter. If signal value monitoring is activated with "preset value", decide whether the signal value is to be specified by parameters or an object. Configure the required signal value if parameters is specified.

The counter counts the operating hours forwards starting from "0 h". If signal value monitoring is activated, the gateway transmits an "ON" telegram for the group concerned or the single device via the object "Operating hours counter - Counter reading elapsed - Status" as soon as the specified signal value is reached. Otherwise, the counter operation is first transmitted when the maximum value is reached.

- Set the "Counting direction" parameter to "Backward". Activate the "Specify start value" parameter if it is necessary to specify the start value. Otherwise deactivate the parameter. If start value monitoring is activated with "preset value", decide whether the start value is to be specified by parameters or an object. Configure the required start value if parameters is specified.

The counter counts the operating hours down to "0" after a restart. With a start value preset, the start value is counted down, otherwise the counting operation starts at the maximum value. The gateway transmits an "ON" telegram for the affected group or the single device via the object "Operating hours counter - Counter reading elapsed - Status" as soon as the value "0" is reached.

- i** The value of the communication object "Operating hours counter - Counter reading elapsed - Status" is permanently stored internally in the device. When switching on the bus/mains voltage or after an ETS programming operation, the object is initialised with the most recently saved value. If, in this case, an operating hours counter is identified as elapsed, i. e. if the object value is set to "ON", an additional telegram is actively transmitted to the KNX as soon as the configured transmit delay has elapsed after the bus/mains voltage returns. If the counter has not yet elapsed ("OFF" object value), no telegram is transmitted after the bus/mains voltage returns or after an ETS programming operation.
- i** If a signal value or start value is specified by the communication object, the values received via the object are not accepted as valid and permanently stored internally in the device until the operating hours counter is restarted. On switching on the supply voltage or after an ETS programming operation, the object is initialised with the most recently saved value. The values received are lost in the event of a mains voltage failure or due to an ETS programming operation if no counter restart was executed beforehand. For this reason,

when specifying a new signal or start value, it is advisable always to restart the counter afterwards as well. A standard value of 65,535 hours or 2,147,483,647 seconds is predefined provided that no signal value or start value has been received yet via the object. The values received and stored via the object are reset to the standard value if the operating hours counter is disabled in the parameters of the ETS and an ETS programming operation is being performed.

- i** If a signal value or start value is specified by the object: If the signal or value or start value is specified with "0", the gateway will ignore a counter restart in order to avoid an undesired reset (e.g. in construction site mode -> operating hours already counted in manual operation).
- i** If the counting direction of an operating hours counter is reversed by reconfiguration in the ETS, the counter should always be restarted after programming the gateway so that the counter is reinitialised.

Restarting the operating hours counter

The counter reading of the operating hours can be reset at any time by the communication object "Operating hours counter - Reset". The polarity of the reset telegram is predefined: "1" = Restart / "0" = No reaction.

In the up-counter the counter is initialised with the value "0" after a restart and in the down-counter initialised with the start value. If no start value was configured or predefined by the object, the start value is preset to 65535 hours or 2,147,483,647 seconds.

During every counter restart, the initialised counter reading is transmitted actively to the KNX. After a restart, the signal of a counter operation is also reset. At the same time, an "OFF" telegram is transmitted to the KNX via the object "Operating hours counter - Counter reading elapsed - Status". In addition, the signal or start value is initialised.

- i** If a new signal or start value was specified via the communication object, the counter should always be restarted afterwards too. Otherwise, the values received will be lost in the case of a bus voltage failure or by an ETS programming operation.
- i** If a signal value or start value is specified with "0", there are different behaviours after a restart, depending on the value specification principle...
If specified by parameters:
The counter elapses immediately after a counter restart.
Preset via object:
A counter restart will be ignored to avoid an undesired reset (e.g. after installation of the devices with hours already being counted by manual operation). A start value or signal value greater than "0" must be specified in order to perform the restart.

Setting the transmission behaviour

The current value of the operating hours counter is continuously tracked in the communication object "Operating hours counter - Counter reading - Status". The content of the object is transmitted to the KNX when there is a change by the set count interval or cyclically active. The object value can also be read out at any time (set read flag).

The operating hours counter must be enabled.

- Set the "Transmission behaviour" parameter on the parameter page "DALI system... -> Configuration groups -> [x] Group name -> Operating hours counter" or "DALI system... -> Configuration single devices -> [x] Device name -> Operating hours counter" to "On change by interval value". Configure the parameter "Counting interval" to the desired value.

The counter reading is transmitted to the KNX as soon as it changes by the specified counting interval.

- Set the parameter "Transmission behaviour" to "cyclical".

The counter value is transmitted cyclically. The cycle time is defined via the parameter of the same name.

-  After the bus/mains voltage returns or an ETS programming operation, the counter reading is always immediately transmitted automatically.

9.9.1 Parameters for operating hours counter

DALI system... -> Configuration groups -> [x] Group name -> Enabled functions

DALI system... -> Configuration single devices -> [x] Device name -> Enabled functions

Operating hours counter	Checkbox (yes/no)
<p>The operating hours counter can be enabled here. The operating hours counter determines the switch-on time of a group or single device. A group or single device is switched on for the operating hours counter if the lamp is lit.</p> <p>If the operating hours counter is not enabled, no operating hours will be counted for the group concerned or the single device. Once the operating hours counter is enabled, however, the operating hours will be determined and added up by the ETS immediately after commissioning the gateway.</p> <p>If the operating hours counter is subsequently disabled again in the parameters and the gateway is programmed with this disabling function, all operating hours previously counted will be deleted. When enabled again, the counter reading of the operating hours counter is always set to "0".</p>	

DALI system... -> Configuration groups -> [x] Group name -> Operating hours counter

DALI system... -> Configuration single devices -> [x] Device name -> Operating hours counter

Counting method	Seconds Hours
<p>The operating hours counter can either be configured as a second counter or alternatively as an hour counter.</p> <p>Seconds: The gateway adds the determined switch-on time for a switched-on group or single device to the second. The totalled operating seconds are added in a 4-byte counter and stored permanently in the device. The current counter reading can be transmitted cyclically to the KNX by the "Operating hours counter - Counter reading - Status" communication object or when there is a change in an interval value in accordance with DPT 13.100.</p> <p>Hours: The gateway adds up the determined switch-on time for a switched-on group or single device to full operating hours to the minute. The totalled operating hours are added in a 2-byte counter and stored permanently in the device. The current counter reading can be transmitted cyclically to the KNX by the "Operating hours counter - Counter reading - Status" communication object or when there is a change in an interval value in accordance with DPT 7.007.</p>	

Counting direction	Forwards Backwards
<p>The operating hours counter can be configured as an up-counter or down-counter. The setting here influences the visibility of the other parameters and objects of the operating hours counter.</p>	

Specify signal value	Checkbox (yes/no)
If the up-counter is used, a signal value can optionally be predefined. This parameter is visible only in "forwards" counting direction.	
Preset value	via parameter via object
This parameter defines whether the signal value can be set via a separate parameter or adapted individually by a communication object from the bus. This parameter is visible only in "forwards" counting direction.	
Signal value	0...2147483647* 0...65535**
The signal value of the up-counter is set here. Once the signal value is reached, an "ON" telegram is transmitted via the object "Operating hours counter - Counter elapsed - Status". The counter itself continues until the maximum counter status is reached and then stops. *: With second counter **: With hour counter This parameter is visible only if the parameter "Specify signal value" is activated and the "Preset value" parameter set to "via parameter".	
Specify start value	Checkbox (yes/no)
If the down-counter is used, a start value can optionally be predefined. This parameter is visible only in "backwards" counting direction.	
Preset value	via parameter via object
This parameter defines whether the start value can be set via a separate parameter or adapted individually by a communication object from the bus. This parameter is visible only in "backwards" counting direction.	
Start value	0...2147483647* 0...65535**
The start value of the down-counter is set here. *: With second counter **: With hour counter This parameter is visible only if the parameter "Specify start value" is activated and the "Preset value " parameter set to "via parameter".	

Transmission behaviour	cyclical after change by interval value
<p>The current value of the operating hours counter is continuously tracked in the communication object "Operating hours counter - Counter reading - Status". The content of the object is transmitted to the KNX when there is a change by the set count interval or cyclically active.</p> <p>Cyclical: The counter value is transmitted cyclically. The cycle time is defined via the parameter of the same name.</p> <p>After change by interval value: The counter reading is transmitted to the KNX as soon as it is changed by the specified counting interval.</p>	
Cycle time	0...23 h 0...15...59 min 0...59 s
<p>This parameter defines the cycle time for the cyclical transmission. Setting the cycle time hours, minutes and seconds.</p> <p>This parameter is available only with "Transmission behaviour = cyclical".</p>	
Counting interval	0...3600...2,147,483,647 s * 0...1...65,535 h **
<p>The interval of the counter value is set here for automatic transmission. The current counter reading is transmitted to the KNX after the interval configured here.</p> <p>*: With second counter **: With hour counter</p> <p>This parameter is available only with "Transmission behaviour = on change by interval value".</p>	

9.9.2 Objects for operating hours counter

Function	Name	Type	DPT	Flag
Operating hours counter - Restart	Group 1...32 / Single device 1...64	1-bit	1.015	C, -, W, -, U
1-bit object for resetting the operating hours counter ("1" = restart, "0" = no reaction).				
Function	Name	Type	DPT	Flag
Operating hours counter - Counter reading - Status	Group 1...32 / Single device 1...64	4-byte	13.100	C, R, -, T, A
<p>4-byte object to transmit or read out the current counter reading of the operating hours counter. Value range: 0...2,147,483,647 seconds</p> <p>The value of the communication object is not lost in the event of a bus/mains voltage failure and is actively transmitted to the KNX after the bus/mains voltage returns or an ETS programming operation. In the as-delivered state, the value is "0".</p> <p>This object is only available with the second counter.</p>				

Function	Name	Type	DPT	Flag
Operating hours counter - Counter reading - Status	Group 1...32 / Single device 1...64	2-byte	7.007	C, R, -, T, A
<p>2-byte object to transmit or read out the current counter reading of the operating hours counter. Value range: 0...65,535 hours</p> <p>The value of the communication object is not lost in the event of a bus/mains voltage failure and is actively transmitted to the KNX after the bus/mains voltage returns or after an ETS programming operation. In the as-delivered state, the value is "0".</p> <p>This object is only available with the hour counter.</p>				

Function	Name	Type	DPT	Flag
Operating hours counter - Counter elapsed	Group 1...32 / Single device 1...64	1-bit	1.002	C, R, -, T, A
<p>1-bit object to signal that the operating hours counter has elapsed (forwards counter = signal value reached / backwards counter = value "0" reached). With a message, the object value is actively transmitted to the KNX ("1" = message active / "0" = message inactive).</p> <p>The value of the communication object is not lost in the event of a bus/mains voltage failure and is actively transmitted to the KNX after the bus/mains voltage returns or after an ETS programming operation. In the as-delivered state, the value is "0".</p>				

Function	Name	Type	DPT	Flag
Operating hours counter - Signal value / Start value	Group 1...32 / Single device 1...64	4-byte	13.100	C, -, W, -, U
<p>4-byte object for external specification of a signal/start value of the operating hours counter. Value range: 0...2,147,483,647 seconds</p> <p>This object is only available with the second counter.</p>				

Function	Name	Type	DPT	Flag
Operating hours counter - Signal value / Start value	Group 1...32 / Single device 1...64	2-byte	7.007	C, -, W, -, U
<p>2-byte object for external specification of a signal/start value of the operating hours counter. Value range: 0...65,535 hours</p> <p>This object is only available with the hour counter.</p>				

10 Scene function

Luminaires or luminaire groups can optionally be integrated in up to 16 scenes, which means that pre-programmed static light scenes can be recalled by influencing the brightness, colour temperature or colour. If necessary, the scene values can be switched over and individually adapted and saved during operation of the device, allowing the user to replace the presettings of the ETS as desired. The extended scene recall allows scenes to be switched over by switching commands.

The scene function must be enabled separately on the parameter page "DALI system... -> Scenes" for a DALI system so that the required communication objects and parameters become available.

Each scene receives a unique number (1...16), which is shown in square brackets before the name in the view of the parameter pages. This number is only a label within the ETS in order to distinguish clearly between the individual scenes, even if they have the same name. In addition, scenes have KNX numbers (1...64). These KNX numbers can be used to recall a scene or a scene memory function using the scene extension object. Scene numbers do not have to be identical to KNX extension numbers. However, KNX numbers must be unique. It is not possible to assign the same KNX numbers to multiple scenes of a DALI system.

The scene configuration selected in the ETS decides whether the number of scenes is either variable (1...16) or alternatively fixed to the maximum (16).

- Scene configuration = "variable (1 ... 16 scenes)"
With this setting, the number of scenes used can be selected anywhere in the range 1 to 16. The "Number of scenes" parameter decides how many scenes are available in the ETS for the selected DALI system. It is possible to specify which scene number (1 ... 64) controls each scene. If necessary, individual scenes can be switched to inactive by configuring the scene number "0".
- Scene configuration = "fixed (16 scenes)"
With this setting, all scenes are always visible and can therefore be used. The scenes are controlled via permanently assigned scene numbers (1 ... 16) (scene number 1 -> scene 1, scene number 2 -> scene 2 ...). If necessary, individual scenes can be deactivated.

A scene recall overrides a brightness value specification and a switching or dimming process and also colour temperature or colour specifications by means of the respective communication objects. A staircase function is also overridden by a scene recall. The priority of the scene function over the disabling or forced position functions of a group or a single device can be configured for each scene. Thus, it is possible for a scene recall to override a disabling or forced position function. Alternatively, a scene can have a lower priority, which means that disabling functions or forced positions cannot be overridden by a scene recall. A function overridden by a scene recall is executed again when the function is updated via the KNX.

A scene recall can optionally take place after a delay.

-  Scenes are influenced by the global addressing type and by the general configuration of the groups and single devices. Therefore, the global and general parameters must be set first before the scene configuration takes place!

- i** In a parameter table of a scene, the groups are always listed first, and then the single devices. If additional groups are subsequently added after the scene has been configured, please note that the newly added groups are inserted into the parameter table before any existing single devices. This gives the new groups the configuration of the previously existing single devices. In this case, the scene configuration must be checked and, if necessary, adjusted manually. This situation does not apply if no single devices are configured.

Configuring extended scene recall

The extended scene recall allows up to 16 scenes of a DALI system to be called up in sequence. Here, scene recall takes place via the 1-bit communication object "Extended scene recall". Each ON telegram received via this object recalls the next of the available scenes in the configuration. Each OFF telegram received recalls the previous scene.

In the event of an extended scene recall, the gateway always recalls the neighbouring scene - starting with the scene most recently recalled by the extended recall. It is irrelevant whether the scene is active (scene number = "1..64" or scene active) or inactive (scene number = "0" or scene inactive). When an ineffective scene is recalled by the extended scene recall, the assigned group or single device does not react.

Only the scenes available in the scene configuration can be selected via the extended scene recall (with "variable" defined by the parameter "number of scenes", with "fixed" always all 16 scenes). After a reset (bus/mains voltage return, ETS programming operation), an ON or OFF telegram always recalls scene 1 first.

- i** Recall of a scene via the 1-byte extension object does not influence the scene sequence of the extended scene recall. The two recall functions work independently of each other.

- Activate the "Extended scene recall" parameter on the parameter page "DALI system... -> Scenes".

The object "Extended scene recall" is available. Each ON telegram recalls the next scene. Each OFF telegram recalls the previous scene.

- Deactivate the "Extended scene recall" parameter.

The extended scene recall is deactivated. A scene can be recalled only with the 1-byte extension device object.

The extended scene recall can take place with or without an overflow at the scene limits. An overflow occurs when the last scene of the selected configuration is reached when counting up or scene 1 when counting down and an additional telegram is received in the last counting direction. The overflow behaviour is defined in the ETS.

- Activate the parameter "with overflow".

After reaching the last scene of the selected configuration, a further ON telegram of the overflow is executed and scene 1 is recalled. Similarly, after reaching scene 1, the overflow is executed by further OFF telegram and the last scene of the selected configuration is recalled.

- Deactivate the parameter "With overflow".
A scene overflow is not possible. After reaching the last scene of the selected configuration, further ON telegrams of the extended scene recall are ignored. In the same way, the gateway ignores further OFF telegrams if scene 1 was recalled last.

Configuring the group and device assignment of a scene

Groups and single devices can be assigned to a scene without restrictions. Each group and each single device can be assigned independently by selecting the "Assignment" checkbox behind in the group or single device name in the parameter table of a scene. Any existing groups and single devices whose checkboxes are not activated are not assigned to the scene. All groups or single devices of the gateway that have not been created are not available in a scene table.

- i** To make it easier to identify the available groups and single devices in the parameter table of a scene, the group and single device numbers are displayed in square brackets (groups [1]...[32] / single devices [1]...[64]), the type "group" or "single device" and the projected designation in the table. The designation can be individually adapted on the parameter pages for the configuration of the groups and single devices.
- i** Special feature when using the ETS5: Due to a functional limitation, the ETS5 may display the type and designation of a group or single device in English.
- i** Scenes can be used for a central control (broadcast). In this case, only one group can be configured as the central group in each scene.
- Activate the "Assignment" parameter of the groups and single devices to be assigned to the selected scene.
The activated groups and single devices are assigned to the scene. The scene parameters for value configuration (brightness value, colour temperature value, colour values) are enabled, depending on which range of functions is configured.

Setting scene values

For each group integrated in a scene and for each integrated single device, it is necessary to specify which brightness value is to be set when a scene is recalled. When using colour temperature control, a colour temperature can also be defined for each assigned group or single device. The same applies to the colour control.

A group or a single device must be assigned to a scene.

- On the parameter page "DALI system... -> Scenes -> [...] Scene...", specify the scene brightness value required for each assigned group and single device. Deactivate the "Active" parameter if the corresponding group or the single device is not to change any brightness value when the selected scene is recalled.

During a scene recall, the respective configured brightness value is set on the operating devices.

In the setting "Active = deactivated", the brightness value of the group or single device remains unchanged when recalling the scene.

- When using the colour temperature control: specify the necessary scene colour temperature value for each assigned group and single device. Deactivate the "Active" parameter if the corresponding group or the single device is not to change any colour temperature value when the selected scene is recalled.

During a scene recall, the appropriate configured colour temperature is set on the operating devices. It should be noted that a colour temperature specified in the scene is only visually effective for the DALI lights if the group or single device is switched on too.

Even if groups or single devices are switched off, colour temperature changes are tracked internally in the device when recalling a scene. When switching on a group or single device after a scene recall, the colour temperature most recently recalled according to the scene is set in the DALI lights.

In the setting "Active = deactivated", the colour temperature value of the group or the single device remains unchanged when the scene is called up.

- When using colour control: specify the necessary scene colour value and, if necessary, a scene white value for each assigned group and single device. Deactivate the "Active" parameter if the corresponding group or single device should not change any colour values when the selected scene is recalled.

When a scene is recalled, the respective configured colour and, if applicable, the white value are set in the operating devices. It should be noted that a colour specified in the scene is only visually effective in the DALI lights if the group or single device is switched on too.

Even if groups or single devices are switched off, colour changes are tracked internally in the device when recalling a scene. When switching on a group or single device after a scene recall, the colour most recently recalled according to the scene is set in the DALI lights.

In the setting "Active = deactivated", the colour values of the group or single device remain unchanged when the scene is called up.

- i** The configured scene values are then adopted in the gateway during an ETS programming operation only if the parameter "Overwrite values stored in the device during the ETS programming operation" is activated.
- i** Recalling a scene also triggers status telegrams, provided they are configured. It should be noted that, even with long scene dimming sequences, the scene target values are transmitted as a status immediately after starting the dimming process, i. e. already when the target value has not yet been statically reached.

- i** The selection of scene values is not limited in the ETS to the configured minimum and maximum values of the groups and single devices. If the scene values are outside the range defined by the minimum and maximum values, the gateway limits the values to the defined limits.
- i** During DALI commissioning, it is possible to assign multiple identical DALI operating devices to different groups (multiple assignment: e.g. Electronic ballast 1 is located in Group A and Group B). If groups (e.g. A & B) have now been assigned to a scene and these groups contain the same operating devices (e.g. electronic ballast 1), there will be a conflict in the event of different scene values. In this case, the operating devices assigned multiple times are set to the values of the group with the highest number.

Presetting the storage behaviour for the scene function

The scene values of assigned groups and single devices can be stored internally in the device when a storage telegram is received by means of the scene extension object during the running time of the gateway. It is possible to influence the values to be saved by all functions of the individual groups and devices before saving them (e.g. switching, dimming, preset value, manual operation). The values are always saved for an entire scene and for all assigned groups and single devices, whereby it can be individually configured which brightness values, colour temperature values or colours are saved.

A group or a single device must be assigned to a scene.

- On the parameter page "DALI system... -> Scenes -> [...] Scene...", activate the "Save" parameter in the "Brightness" category for the groups and single devices that are to include the brightness value in the saving process.
The storage function for the brightness is activated for the group or single device affected. The current brightness value is stored internally in the scene by means of the extension object when receiving a storage telegram.
- Deactivate the "Save" parameter in the "Brightness" category for the groups and single devices that are not to include the brightness value in the saving process.
The storage function for the brightness is deactivated for the group or single device concerned. A storage telegram received via the extension object will be rejected based on the brightness. During a scene recall, the brightness permanently defined in the ETS is then recalled.
- When using colour temperature control: On the parameter page "DALI system... -> Scenes -> [...] Scene...", activate the "Save" parameter in the "Colour temperature" category for the groups and single devices that are to include the colour temperature value in the saving process.
The storage function for the colour temperature is activated for the group or single device concerned. The current colour temperature value is stored internally in the scene by means of the extension object when receiving a storage telegram.

- When using colour temperature control, deactivate the "Save" parameter in the "Colour temperature" category for the groups and single devices that are not to include the colour temperature value in the saving process.

The storage function for the colour temperature is deactivated for the group or single device concerned. A storage telegram received via the extension object is rejected based on the colour temperature. During a scene recall, the colour temperature permanently defined in the ETS is then recalled.

- When using colour control: On the parameter page "DALI system... -> Scenes -> [...] Scene...", activate the "Save" parameter in the "Colour" category for the groups and single devices that are to include the colour values in the saving process.

The storage function for the colours is activated for the group or single device concerned. When a memory telegram is received via the extension object, the current colour values are saved in the scene within the device.

- When using colour control, deactivate the "Save" parameter in the "Colour" category for the groups and single devices that are not to include the colour values in the saving process.

The storage function of the colours is deactivated for the group or single device concerned. A storage telegram received via the extension object is rejected based on the colours. When a scene is called up, the colours defined in the ETS are called up.

- i** Whenever scene values are not active ("Active = deactivated" parameter), the storage function for the affected values cannot be executed. In the ETS, the "Save" parameter cannot be activated in the respective category.

- i** During a saving operation, scene values are saved to an internal non-volatile memory in the gateway, thus overwriting the values of a group or single device programmed by the ETS. The scene values configured in the ETS are then adopted in the gateway during ETS programming again only if the parameter "Overwrite values stored in the device during the ETS programming operation" is activated.

Setting the scene priority

The priority of the scene function over the disabling or forced position functions of a group or single device can be configured for each scene. Thus, it is possible for a scene recall to override a disabling or forced position function. Alternatively, a scene can have a lower priority, which means that disabling functions or forced positions cannot be overridden by a scene recall.

The scene priority can be configured separately for each created scene.

- On the parameter page "DALI system... -> Scenes -> [...] Scene...", configure the parameter "Priority to disabling/forced position" to "low".

The scene has a lower priority to the supplementary functions of the assigned groups or the assigned single devices. It is not possible to call up or save a scene if a supplementary functions is activated only for one assigned group or single device.

- Configure the parameter "Priority to disabling/forced position" to "high".

The scene has a higher priority to the supplementary functions of the assigned groups or the assigned single devices. Scenes are only ever called-up or saved when a scene extension device is received.

A scene recall does not statically lock the lower-level functions of a group or single device. The higher priority only determines that scene values are set at the moment the scene is recalled and override the previously active values. After a scene is recalled, it is possible for the scene values to be subsequently changed by other functions of the gateway (e.g. on terminating a supplementary function or by switching, dimming or preset value).

Setting the ETS programming behaviour for the scene function

When storing a scene, the scene values are stored internally to a non-volatile memory in the device. To prevent the stored values from being replaced during ETS programming of the application or parameters by the originally programmed scene brightness values, the gateway can inhibit overwriting of the scene values. As an alternative, the original values can be reloaded into the device during each programming run of the ETS.

The ETS programming behaviour can be configured separately for each scene.

- On the parameter page "DALI system... -> Scenes -> [...] Scene...", activate the parameter "Overwrite values stored in the device during the ETS programming operation".

During each ETS programming operation of the application program or of the parameters, the scene values configured in the ETS will be programmed into the gateway. Scene values stored in the device by means of a storage function will be overwritten, if any.

- Deactivate the parameter "Overwrite values stored in the device during the ETS programming operation".

Scene values stored in the device with a storage function will be maintained. If no scene values have been stored, the scene values last programmed in the ETS remain valid.

- i** During the initial commissioning of the gateway, this parameter should be set to activated so that the scenes are initialised with valid scene values.

Presetting the recall delay for the scene function

Each scene recall can optionally also be evaluated after a delay. With this feature, dynamical scene sequences can, for example, be configured if several actuators or gateways are combined with cyclical scene telegrams.

The scene recall delay can be configured separately for each created scene.

- On the parameter page "DALI system... -> Scenes -> [...] Scene...", activate the parameter "Delay scene recall". Configure the delay time.

The delay time is activated. The delay only influences the scene recall of the appropriate scene. The delay time is started on arrival of a recall telegram. Only after the time has elapsed is the corresponding scene called up and the scene values set.
- Deactivate the "Delay scene recall" parameter.

The delay time is deactivated. A scene recall is carried out without a delay immediately after the receipt of a scene recall telegram.
- i** Each scene recall telegram restarts the delay time and, in this way, retriggers it.
- i** The scene recall delay has no influence on the storage of scene values. A scene storage telegram within a scene recall delay terminates the delay and thus the scene recall.
- i** All time functions are stopped if the mains voltage supply to the gateway fails. Therefore, all scene recalls that are still in the delay stage will be aborted. A scene recall received shortly before a mains voltage failure will then be lost if the corresponding delay has not yet elapsed. A bus voltage failure alone does not stop an elapsing delay. If the mains voltage supply is still available, the last scene called up is executed at the end of the delay. A delayed scene recall is aborted for the affected groups or single devices also if a function of higher priority (e.g. manual operation, forced position function, disabling function) is activated.

Setting the dimming behaviour when recalling a scene

In the scene configuration, it is possible to define whether the scene values for the assigned groups or single devices jump instantly or dim. A scene recall can therefore be executed independently of the set dimming behaviour.

The behaviour during a scene recall can be configured separately for each scene.

- On the parameter page "DALI system... -> Scenes -> [...] Scene...", set the parameter "On scene request" to "Jumping to values".

The values of the scene concerned are jumped to instantly during a recall.
- Set the "On scene request" parameter to "dimming values via fading". At the same time, define the required fading time.

The values of the scene concerned are dimmed to during a recall. The dim fading is activated. The fading time defines the duration of the dimming process until the new values are achieved. The brightness, colour temperature and colour values of a group or single device at which the dimming process starts has no significance. The dimming process in the event of a scene recall always requires the exactly specified time for all groups and single devices of the scene.

- i** All DALI operating devices included in the scene (through groups or as a single device) react simultaneously, because addressing takes place on the DALI side using scene commands (Multicast), which the gateway programs into the operating device during initialisation, depending on the scene configuration.
- i** The configured dimming time for the dim fading of the scene function may deviate from the standard dimming behaviour of a group or a single device. The gateway always works with a standard fading time of 0.7 seconds. This value is automatically programmed into DALI operating devices during initialisation. Directly after scene recall, the gateway reprograms all the assigned DALI operating devices to the dimming time of the scene. After recalling the scene, the gateway immediately re-programs the fading time back to the original value.

10.1 Parameters for scenes

DALI system... -> Scenes

Scene function	Checkbox (yes/no)
<p>Luminaires or luminaire groups can optionally be integrated in up to 16 scenes, which means that pre-programmed static light scenes can be recalled by influencing the brightness, colour temperature or colour. If necessary, the scene values can be switched over and individually adapted and saved during operation of the device, allowing the user to replace the presettings of the ETS as desired. The extended scene recall allows scenes to be switched over by switching commands.</p> <p>The scene function must be enabled by this parameter so that the required communication objects and parameters become available.</p>	

Extended scene recall	Checkbox (yes/no)
<p>The extended scene recall allows up to 16 scenes of a DALI system to be called up in sequence. Here, scene recall takes place via the 1-bit communication object "Extended scene recall". Each ON telegram received via this object recalls the next of the available scenes in the configuration. Each OFF telegram received recalls the previous scene.</p> <p>In the event of an extended scene recall, the gateway always recalls the neighbouring scene - starting with the scene most recently recalled by the extended recall. It is irrelevant whether the scene is active (scene number = "1...64" or scene active) or inactive (scene number = "0" or scene inactive). When an ineffective scene is recalled by the extended scene recall, the assigned group or single device does not react.</p> <p>Only the scenes available in the scene configuration can be selected via the extended scene recall (with "variable" defined by the parameter "number of scenes", with "fixed" always all 16 scenes). After a reset (bus/mains voltage return, ETS programming operation), an ON or OFF telegram always recalls scene 1 first.</p>	

With overflow	Checkbox (yes/no)
<p>The extended scene recall can take place with or without an overflow at the scene limits. An overflow occurs when the last scene of the selected configuration is reached when counting up or scene 1 when counting down and an additional telegram is received in the last counting direction.</p>	
Scene configuration	variable (1...16 scenes) fixed (16 scenes)
<p>Each scene receives a unique number (1...16), which is shown in square brackets before the name in the view of the parameter pages. This number is only a label within the ETS in order to distinguish clearly between the individual scenes, even if they have the same name. In addition, scenes have KNX numbers (1...64). These KNX numbers can be used to recall a scene or a scene memory function using the scene extension object. Scene numbers do not have to be identical to KNX extension numbers. However, KNX numbers must be unique. It is not possible to assign the same KNX numbers to multiple scenes of a DALI system.</p> <p>The scene configuration selected here decides whether the number of scenes is either variable (1 ... 16) or alternatively fixed to the maximum (16).</p> <p>variable (1...16 scenes): With this setting, the number of scenes used can be selected anywhere in the range 1 to 16. The "Number of scenes" parameter decides how many scenes are available in the ETS for the selected DALI system. It is possible to specify which scene number (1 ... 64) controls each scene. If necessary, individual scenes can be switched to inactive by configuring the scene number "0".</p> <p>fixed (16 scenes): With this setting, all scenes are always visible and can therefore be used. The scenes are controlled via permanently assigned scene numbers (1 ... 16) (scene number 1 -> scene 1, scene number 2 -> scene 2 ...). If necessary, individual scenes can be deactivated.</p>	
Number of scenes	1...10...16
<p>This parameter decides how many scenes are available in the ETS for the selected DALI system.</p> <p>This parameter is only available with variable scene configuration.</p>	

KNX scene number	0...64
<p>Each scene receives a unique number (1...16), which is shown in square brackets before the name in the view of the parameter pages. This number is only a label within the ETS in order to distinguish clearly between the individual scenes, even if they have the same name. In addition, scenes have KNX numbers (1...64). These KNX numbers can be used to recall a scene or a scene memory function using the scene extension object. Scene numbers do not have to be identical to KNX extension numbers. However, KNX numbers must be unique. It is not possible to assign the same KNX numbers to multiple scenes of a DALI system. If necessary, individual scenes can be switched to inactive by configuring the scene number "0".</p> <p>The default setting of the parameter depends on the number of the selected scene.</p> <p>This parameter is only available with variable scene configuration. With a fixed scene configuration, the scenes are controlled by permanently assigned scene numbers.</p>	

Scene active	Checkbox (yes/no)
<p>With a fixed scene configuration, individual scenes can be switched to inactive by this parameter if necessary.</p> <p>This parameter is only available with fixed scene configuration.</p>	

Name	Scene...
<p>Each scene can be given a designation, which is visible only in the ETS for better identification.</p>	

DALI system... -> Scenes -> Scene...

Priority to disabling/forced position	low high
<p>The priority of the scene function over the disabling or forced position functions of a group or single device can be configured for each scene. Thus, it is possible for a scene recall to override a disabling or forced position function. Alternatively, a scene can have a lower priority, which means that disabling functions or forced positions cannot be overridden by a scene recall.</p> <p>Low: The scene is of lower priority to the supplementary functions of the assigned groups or single devices. It is not possible to call up or save a scene if a supplementary functions is activated only for one assigned group or single device.</p> <p>High: The scene is of higher priority to the supplementary functions of the assigned groups or single devices. Scenes are only ever called-up or saved when a scene extension device is received. A scene recall does not statically lock the lower-level functions of a group or single device. The higher priority only determines that scene values are set at the moment the scene is recalled and override the previously active values. After a scene is recalled, it is possible for the scene values to be subsequently changed by other functions of the gateway (e.g. on terminating a supplementary function or by switching, dimming or preset value).</p>	

Overwrite values stored in the device during the ETS programming operation	Checkbox (yes/no)
<p>When storing a scene, the scene values are stored internally to a non-volatile memory in the device. To prevent the stored values from being replaced during ETS programming of the application or parameters by the originally programmed scene brightness values, the gateway can inhibit overwriting of the scene values. As an alternative, the original values can be reloaded into the device during each programming run of the ETS.</p> <p>Parameter activated: During each ETS programming operation of the application program or of the parameters, the scene values configured in the ETS are programmed into the gateway. Scene values stored in the device by means of a storage function will be overwritten, if any.</p> <p>Parameter deactivated: The scene values stored in the device by a storage function are maintained. If no scene values have been stored, the scene values last programmed in the ETS remain valid.</p>	
Delay scene recall	Checkbox (yes/no)
<p>Each scene recall can optionally also be evaluated after a delay. With this feature, dynamical scene sequences can, for example, be configured if several actuators or gateways are combined with cyclical scene telegrams.</p> <p>Parameter activated: The delay time is activated. The delay only influences the scene recall of the appropriate scene. The delay time is started on arrival of a recall telegram. Only after the time has elapsed is the corresponding scene called up and the scene values set.</p> <p>Parameter deactivated: The delay time is deactivated. A scene recall is carried out without a delay immediately after the receipt of a scene recall telegram.</p>	
Delay time	0...59 min 0...10...59 s
<p>The delay time configured here is started when a recall telegram arrives. Only after the time has elapsed is the corresponding scene called up and the scene values set. Each scene recall telegram restarts the delay time and retriggers it. If a new scene recall telegram is received while a delay is active (scene recall not yet executed), the old (and not yet recalled scene) will be rejected and only the scene last received executed.</p> <p>This parameter is available only when the scene recall delay is active.</p>	

On scene request	jumping to values dimming values via fading
<p>You can define here whether the scene values for the assigned groups or single devices are to be called up by being instantly jumped to or dimmed to. A scene recall can therefore be executed independently of the set dimming behaviour.</p> <p>Jumping to values: The values of the scene concerned are jumped to instantly during a recall.</p> <p>Dimming to values via fading: The values of the scene concerned are dimmed to during a recall. The dim fading is activated. The fading time defines the duration of the dimming process until the new values are achieved. The brightness, colour temperature and colour values of a group or single device at which the dimming process starts has no significance. The dimming process in the event of a scene recall always requires the exactly specified time for all groups and single devices of the scene.</p>	
Fading time	Fading (0.7 s) Fading (1.4 s) Fading (2.0 s) Fading (2.8 s) Fading (4.0 s) Fading (5.7 s) Fading (8.0 s) Fading (11.3 s) Fading (16.0 s) Fading (22.5 s) Fading (32.0 s) Fading (45.3 s) Fading (64.0 s) Fading (90.5 s)
Setting of the fading time for dimming to the scene values. This parameter is available only for "On scene request = dimming values via fading".	
Assign	Checkbox (yes/no)
This parameter defines the assignment of the group or single device to the scene. Only assigned groups and single devices are processed during a scene recall or when saving a scene. If this parameter is deactivated, no scene parameters can be set for the corresponding group or single device.	

Brightness Active	Checkbox (yes/no)
<p>This parameter defines the assignment of the group or single device to the brightness control of the scene. If the checkbox is selected, the scene influences the brightness. If it is deleted, the brightness value of the group or single device remains unchanged when the scene is recalled.</p>	
Brightness Value	OFF, 1%, 2%, 3%, 4%, 5%, 6%, 7%, 8%, 9%, 10%, 15%, 20%...50%...100%
<p>During a scene recall, the appropriate configured brightness value is set on the operating devices.</p>	
Brightness Save	Checkbox (yes/no)
<p>The current brightness value can be saved in the gateway when a storage telegram is received via the scene extension object. When the checkbox is activated, the brightness storage function is activated for the group or single device concerned. The current brightness value is stored in the gateway in the scene via the extension object when a storage telegram is received.</p>	
Colour temperature Active	Checkbox (yes/no)
<p>This parameter defines the assignment of the group or single device to the colour temperature control of the scene. If the checkbox is selected, the scene influences the colour temperature. If it is deleted, the colour temperature value of the group or single device remains unchanged when the scene is recalled.</p> <p>The "Colour temperature" category is available only for groups or single devices that enable this range of functions.</p>	
Colour temperature Value	1,000...2,000...10,000
<p>When a scene is recalled, the respective configured colour temperature value is set on the operating devices.</p>	
Colour temperature Save	Checkbox (yes/no)
<p>The current colour temperature value can be saved in the gateway when a storage telegram is received via the scene extension object. When the checkbox is activated, the colour temperature storage function is activated for the group or single device concerned. The current colour temperature value is stored in the gateway in the scene via the extension object when a storage telegram is received.</p>	

Colour Active	Checkbox (yes/no)
<p>This parameter defines the assignment of the group or single device to the colour control of the scene. If the checkbox is selected, the scene influences the colour and optionally the white value. If it is deleted, the colour or the white value of the group or single device remains unchanged when the scene is recalled.</p> <p>The "Colour" category is available only for groups or single devices that enable this range of functions.</p>	
Colour Colour value	#000000...#FFFFFF
<p>When a scene is recalled, the respective configured RGB colour value is set on the operating devices.</p>	
Colour White value	0...255
<p>For groups and single devices, a white value can also be defined in the scene in addition to the RGB colour value in the "Colour RGBW" scope of functions.</p>	
Colour Save	Checkbox (yes/no)
<p>The current colour value can be saved in the gateway when a storage telegram is received via the scene extension object. When the checkbox is activated, the storage function for the colour and optionally also the white value is activated for the group or single device concerned. When a storage telegram is received via the extension object, the colour and the white value in the gateway are stored in the scene.</p>	

10.2 Objects for scenes

Function	Name	Type	DPT	Flag
Scenes - Extension	DALI system... - Input	1-byte	18.001	C, -, W, -, U
<p>1-byte object for recalling scenes (bit 7 deleted) or for storing new scene values (bit 7 set). Bits 0...6 carry the KNX scene number (data value 0...63 -> KNX scene number 1...64).</p>				
Function	Name	Type	DPT	Flag
Extended scene recall	DALI system... - Input	1-bit	1.001	C, -, W, -, U
<p>1-bit object for extended scene recall. Each ON telegram received recalls the next scene in sequence. Each OFF telegram received recalls the previous scene. After a reset (bus/mains voltage return, ETS programming operation), an ON or OFF telegram always recalls scene 1 first.</p>				

11 Device Configuration App (DCA)

To carry out the DALI commissioning and the DALI test, a completely ETS-integrated Device Configuration App (DCA), which supplements the standard parameter dialogue, is used. This enables the identification, addressing and assignment of DALI control gears by using the familiar ETS environment without having to use additional software beyond the ETS.

The DCA technology is manufacturer-neutral and not part of the ETS application. Each DCA must be downloaded free of charge from the KNX Association App Shop (www.knx.org) and then installed in the ETS App Console. As soon as the DCA has been installed in the ETS, a "DCA" tab is available on the gateway in the project planning window next to the parameter dialogue.

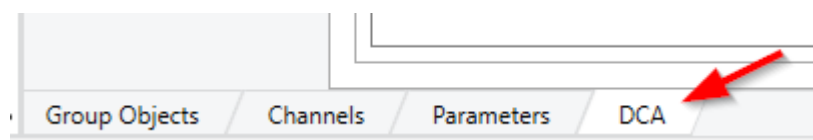

Figure 59: DCA tab in the configuration window for calling up the Device Configuration App

- i** Project design and commissioning of the device is possible using ETS5 (from version 5.7.7) or ETS6 (from version 6.1.0). The DCA is identical for these ETS generations.
- i** Unfortunately, the "Undo" function of the ETS has only insufficient influence on DCA. Consequently, this ETS function should not be used when working with the DCA.
- i** The "DCA" tab of the ETS is always located next to the "Parameters" tab in the configuration window of a selected device. In the ETS, several project planning windows can be opened simultaneously in the workspace. To ensure that the interaction between the device parameters and the DCA always functions smoothly, parameters and DCA functions should only ever be edited in the same configuration window!

Clicking on the "DCA" tab in the project planning window of the ETS immediately opens the Device Configuration App with the Welcome window.

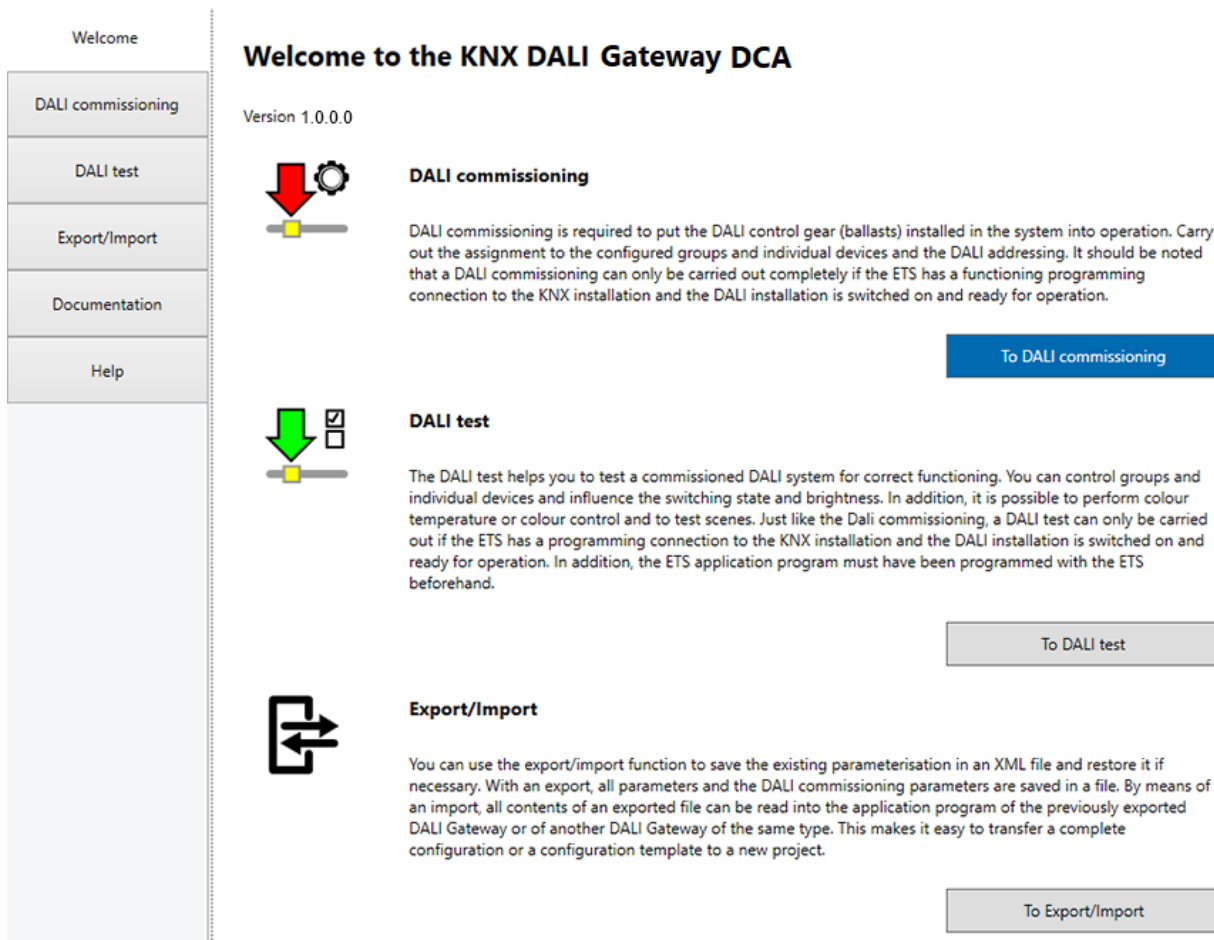

Figure 60: DCA - Welcome Window

The DCA implements the following functions:

- **DALI commissioning**
DALI commissioning is required to put the DALI control gear (ballasts) installed in the system into operation (see chapter "DALI commissioning" ▶ Page 283). With this function, the assignment to the configured groups and single devices and the DALI addressing is carried out. It should be noted that a DALI commissioning can only be carried out completely if the ETS has a functioning programming connection to the KNX installation and the DALI installation is switched on and ready for operation.
- **DALI test**
The DALI test helps to test a commissioned DALI system for correct functioning (see chapter "DALI test" ▶ Page 314). Operating devices that have been found as well as configured groups and single devices can be controlled and the switching status and brightness can be influenced. In addition, it is possible to perform colour temperature or colour control and to test scenes. Just like the DALI commissioning, a DALI test can be carried out only if the ETS has a programming connection to the KNX system and the DALI system is switched on and ready for operation. In addition, the ETS application program must have been programmed with the ETS and a DALI commissioning must have been carried out in order to gain access to all test functions.

- **Export/Import**

With the export/import function, an existing parameterisation can be saved in an XML file and restored if necessary. With an export, all parameters and the DALI commissioning configuration are saved in a file. By means of an import, all contents of an exported file can be read into the application program of the previously exported gateway or of another gateway of the same type (with compatible ETS application). This makes it easy to transfer a complete configuration or a configuration template to a new project.
 - **Documentation**

In the documentation, the DCA exports the configuration of the DALI commissioning of the gateway present in the ETS project into a PDF document. The projected DALI groups and single devices (name, address, type and status) as well as the DALI devices found in the DALI system but not assigned are logged.
 - **Help**

The help contains the function description for the DCA and the ETS application program of the gateway. The help explains the application functions in detail, contains an overview of all parameters and communication objects and describes the procedure for DALI commissioning and DALI testing.
- i** When configuring the "Central" addressing type, no DALI commissioning is required in the DALI system concerned. In this case, the DCA can be used for DALI testing (only broadcast control of all operating devices) and for documentation as well as help.

11.1 DALI commissioning

DALI commissioning is required to put the DALI control gear (ballasts) installed in the system into operation. With this function, the assignment to the configured groups and single devices and the DALI addressing is carried out.

- i** With the "2-fold" device variant, one DALI commissioning is carried out separately for each DALI system. The DALI commissioning environment is then available for each DALI system and is displayed separately. Only one DALI commissioning environment is available for the "1-fold" device variant.

11.1.1 Indication and operating elements in the DCA

DALI commissioning environment

DALI commissioning must be performed after device configuration has been completed (all groups and single devices created / scenes configured / all group addresses assigned). In addition, it is necessary that the gateway has been programmed with the ETS at least once before DALI commissioning so that the device has a physical address and the application program is loaded.

- i** When configuring the "Central" addressing type, no DALI commissioning is required in the DALI system concerned. In this case, the DCA can be used for DALI testing (only broadcast control of all operating devices) and for documentation as well as help.

If the described prerequisites are fulfilled, the "DALI commissioning" can be called up via the tab of the same name or the button in the welcome window of the DCA. After calling up the commissioning, the DALI commissioning environment is visible in the DCA window.

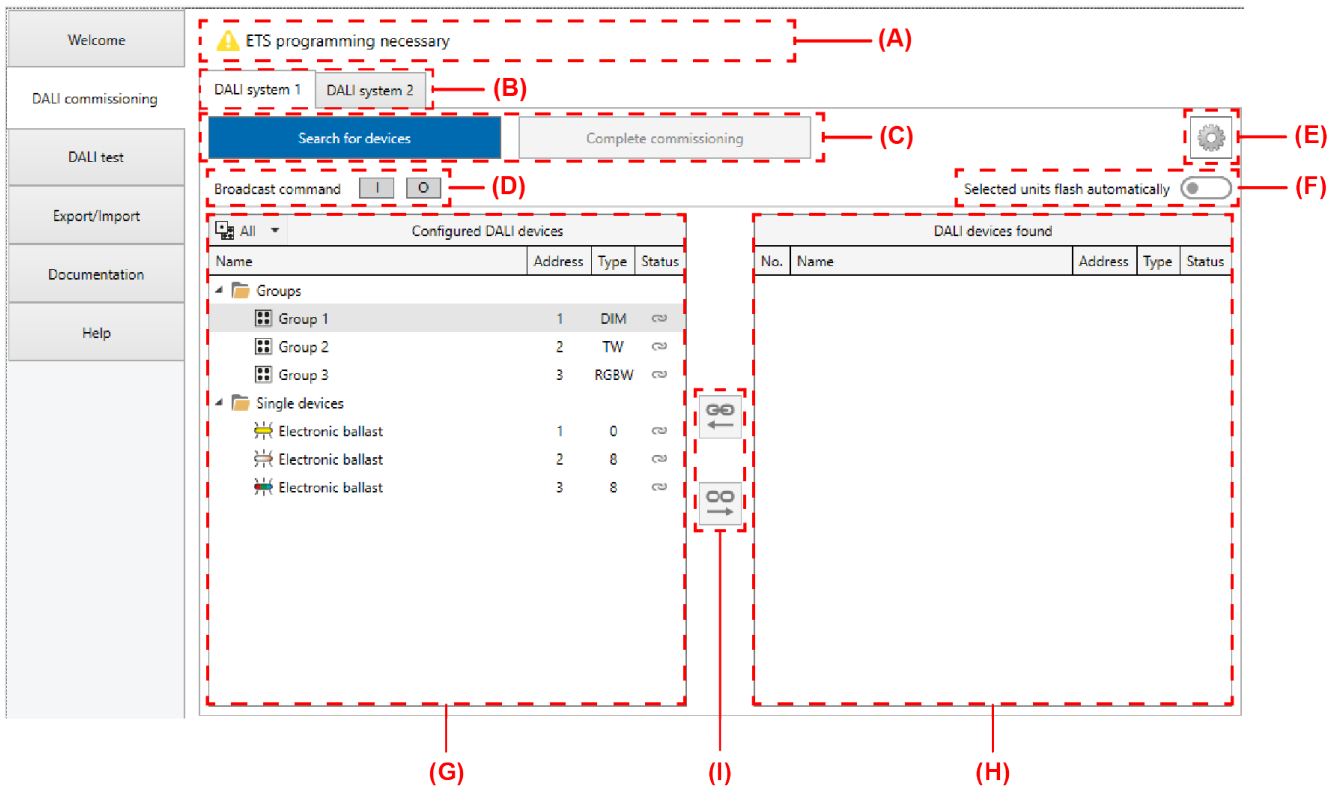

Figure 61: DALI commissioning environment in the DCA

- (A) Display area for status messages
- (B) Tab for switching the DALI systems (only for the "2-fold" device variant)
- (C) Buttons for device search and completion of DALI commissioning
- (D) Buttons for DALI test all ON / OFF (control of all connected DALI operating devices by broadcast)
- (E) Button for context menu (settings and advanced functions)
- (F) Slide switch for switching on and off the automatic flashing mode for device identification
- (G) Display area on the left for configured groups and single devices from the parameter configuration
- (H) Display area on the right for operating devices (electronic ballasts) found from the DALI system
- (I) Buttons for assigning or disconnecting found devices and projected DALI groups or single devices

- i** Elements (C) to (I) are present per DALI system and are evaluated and displayed separately. Switching between the elements is possible with the "2-fold" device variant via the tabs (B). For the "1-fold" device variant, only the "DALI System 1" tab is available.

The left display area (G) shows all groups and single devices that have been set in the parameter view in the course of the project design of the gateway. The names of the groups and single devices as well as the addresses and device types are transferred from the configuration to the indication. The right display area (H) contains all operating devices (electronic ballasts) found in the DALI system. In the course of the DALI commissioning, the DALI operating devices (H) found are linked to the projected groups and single devices (G) by assignment. Only by linking is it possible to control the operating devices later during operation of the gateway using KNX communication objects.

- i** Before the first DALI commissioning, the left display area (G) does not yet show any operating devices. A DALI device search must be carried out first.

DALI Online functions

Some DALI online functions of the DALI commissioning environment (e.g. device search, device identification, completion of commissioning) require a functional programming connection from the ETS to the relevant gateway in the KNX installation. Before executing the DALI online functions, the DCA first checks whether the ETS can communicate with the gateway via the KNX programming connection (status message "🔄 Connection check active"). If this is not the case, no DALI online functions can be carried out. The DCA then displays the status message "⚠️ Error no response" in the display area (A).

For trouble-free DALI commissioning, the gateway must be connected to the KNX line and the bus and mains voltage supply must be switched on without interruption. In addition, the ETS must have a functioning communications interface to the KNX (e.g. USB or IP).

- i** The gateway does not determine the functionality of the DALI line when checking the KNX programming connection.

If it is not possible to establish a connection to the gateway via the KNX programming interface, the cause must be identified. Reasons for a faulty connection and the appropriate remedies are listed below:



- Cause: No functioning ETS communication interface to the KNX.
Remedy: Check, and if necessary, setup the connection in the ETS.
- Cause: Physical address and application program not previously programmed by the ETS.
Remedy: Exit DCA and then program the physical address and the application program with the ETS.
- Cause: KNX bus voltage at the gateway or at the ETS communication interface not connected or ready for operation.
Remedy: Connect and switch on the bus voltage.







- Cause: Mains voltage supply on the gateway not switched on.
Remedy: Switch on the mains supply at the gateway.
-  Some DALI online functions of commissioning expect the DCA to communicate with the appropriate gateway. In order to exclude the possibility that an incorrect gateway in the KNX system is controlled by mistake when executing a DALI online function (e.g. due to an incorrectly programmed physical address), the DCA checks the project ID of the gateway before executing the respective function. DALI online functions should only be carried out if the individual project ID from the ETS project is also contained in the gateway. If the project ID of the device does not match the specifications from the ETS project, the DCA displays a note and expects confirmation from the ETS user in the event of a commissioning completion or a DALI reset. In the case of a device search, no search can be carried out if the project IDs are not identical.

With the "I" and "O" (D) buttons, all operating devices of the selected DALI system can be switched on and off together. The gateway uses a DALI broadcast command for this control. With the help of this function, it is possible to quickly and easily test all participants connected to the DALI system in the course of a DALI commissioning.

Status messages

In the display area (A) of the DALI commissioning environment, the DCA displays status messages that inform the operator of the status of the configuration or commissioning and also provide further information. The possible status messages and their meaning are described below.

- | | | |
|---|------------------------------------|---|
|  | Connection check active | Some DALI online functions of the commissioning environment or the DALI test require a functional programming connection from the ETS to the affected gateway in the KNX installation. The DCA first performs a connection check and checks whether the ETS can communicate with the gateway via the KNX programming connection. If successful, the DALI online function is executed immediately. |
|  | Commissioning not completed | In the course of the DALI commissioning carried out offline, changes have been made to the DALI configuration (e.g. modified group assignments) that still have to be programmed into the gateway. After completing all configurations, commissioning must be completed in the DCA (see chapter "Complete DALI commissioning" ▶ Page 312). |
|  | ETS programming necessary | The DCA has detected that the physical address or the application program of the gateway has not yet been fully programmed in the ETS project. Before a DALI commissioning or a DALI test can be carried out in the DCA, a complete commissioning with the ETS must have been carried out. Complete the ETS commissioning and then switch back to the DCA to perform the DALI commissioning or the DALI test. The DCA cannot be operated during an ETS programming process. |

-  **Error no answer** The DCA could not maintain a stable connection via the KNX to the gateway in the course of an ongoing communication. For trouble-free DALI commissioning or a DALI test, the gateway must be connected to the KNX line and the bus and mains voltage supply must be switched on without interruption. In addition, the ETS must have a functioning communications interface to the KNX (e.g. USB or IP).
-  **DALI system: Standby switch-off active** The DCA has attempted to access the gateway via the KNX to execute a DALI online function. At this moment, the standby switch-off was active in the affected DALI system. DALI online access to the gateway is only possible if the DALI system concerned is in normal operation (no standby shutdown active). To do this, control at least one group or single device via the KNX to deactivate the standby switch-off. Only then carry out another access to the gateway with the DCA.
-  **DALI system: gateway does not respond** The DCA has attempted to access the gateway via the KNX to execute a DALI online function. At this moment, however, the gateway was busy with another function in the affected DALI system (e.g. DALI initialisation after an ETS programming procedure, automatic device replacement via manual operation) or there is a physical error on the DALI line (e.g. short circuit). Access to the gateway is only possible if the DALI system concerned is in normal operation. Wait a short time or remove the malfunction of normal operation and then perform access to the gateway again with the DCA.
-  **Project planning error in the DALI system** An error has occurred in the configuration of the parameters in at least one of the DALI systems (e.g. identical short addresses assigned several times). The DALI commissioning or the DALI test cannot be carried out. To continue or complete the DALI commissioning or to run the DALI test, the configuration error in the affected DALI systems must be removed.
-  **Global project design error** An error has occurred in the configuration of the parameters in at least one of the DALI systems (e.g. error in the scene configuration). The DALI commissioning or the DALI test cannot be carried out. To continue or complete the DALI commissioning or to run the DALI test, the configuration error in the affected DALI systems must be removed.
-  **Connection error** The DCA could not establish a connection via the KNX to the gateway. For trouble-free DALI commissioning or a DALI test, the gateway must be connected to the KNX line and the bus and mains voltage supply must be switched on without interruption. In addition, the ETS must have a functioning communications interface to the KNX (e.g. USB or IP).

- i** Additional information Additional information can be displayed for some status messages. To do this, move the mouse pointer to the status message with the **i** symbol.

Context menus

In the DALI commissioning environment, a context menu (E) is available to access settings and advanced functions. The context menu is called up when the  symbol is clicked with the left or right mouse button.

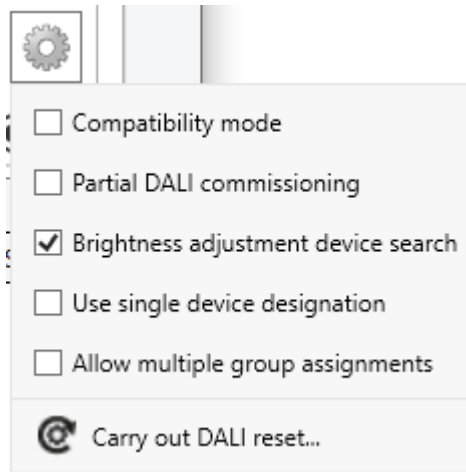

Figure 62: Context menu of the DALI commissioning

- Compatibility mode Through this checkbox, the compatibility mode of the DALI commissioning can optionally be activated (see chapter "Supplementary functions" ▶ Page 308). This means that the commissioning process becomes distinctly more tolerant towards specific DALI commissioning parameters, which means that operating devices not fully compliant with the DALI specification can be commissioned, possibly subject to functional restrictions.
- Partial DALI commissioning This checkbox activates the partial DALI commissioning (see chapter "Supplementary functions" ▶ Page 307). This affects the DALI device search and the finalisation process of the DALI commissioning. If this checkbox is enabled, operating devices that have already been found during a new DALI device search will be retained even if these do not respond to the gateway (e.g. if the mains voltage supply of these operating devices is switched off or the DALI cable was disconnected). This allows DALI systems to be partially commissioned. If the checkbox is disabled, operating devices that have already been found during a new device search will be removed from the configuration if these devices no longer respond to the gateway.
- Brightness adjustment device search During a device search (see chapter "Device search" ▶ Page 294), all connected operating devices of a DALI system can switch on to minimum brightness. This makes it

- Use single device designation

Names of operating devices found and of configured groups and single devices can be edited as desired. If the checkbox is selected, the projected names of the single devices are retained when operating device assignments are cancelled, so that the name is transferred from the left to the right display area. If the checkbox is deselected, the name that was originally assigned to the operating device before the assignment is displayed again in the right display area after the assignment is cancelled. The checkbox has no effect on names of operating devices that were assigned to groups.
- Allow multiple group assignments

Control gear can be assigned to more than one DALI group for group control. To enable this, the checkbox must be selected.
- Carry out DALI reset

With this command, a global reset of the selected DALI system can be executed. With a DALI reset, all devices of the DALI system are reset to the delivery status defined by the manufacturer (see chapter "Supplementary functions" ▶ Page 310).

In the display area for found devices (H), a separate context menu is available for each operating device, via which DALI online functions can be called up with which selected devices can be identified in the DALI system. These operating devices can be made to switch-on, switch-off and flash (cyclical ON and OFF). The device context menu is called up when one or more devices are selected in the display area and then the right mouse button is clicked.

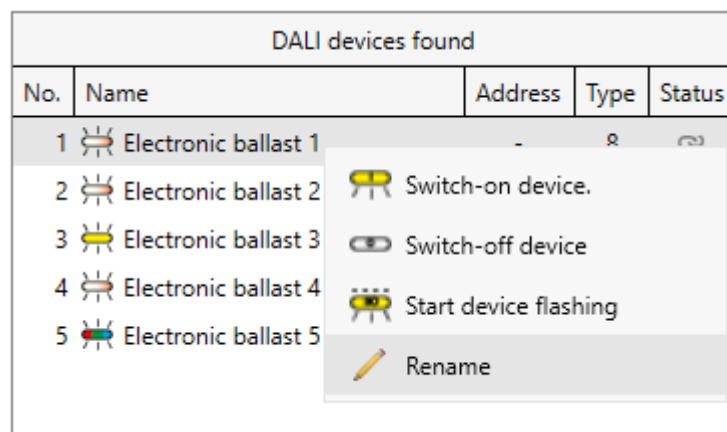











Figure 63: Example of a context menu for operating devices found

- Switch-on device

This DALI online command switches on one selected operating device at a time.

-  This menu item is not available when selecting several operating devices.
-  Switch-off device This DALI online command switches off one selected operating device at a time.
-  This menu item is not available when selecting several operating devices.
-  Start device flashing The DALI online command "Start device flashing" switches selected operating devices on and off cyclically. The switching state changes approx. once a second. During the flashing process, the device symbols in the display area of the DCA also flash.
-  Stop device flashing The flashing process remains active until the DALI online command "Stop device flashing" or another available DALI online function is selected.
-  The menu items "Start device flashing" and "Stop device flashing" are available as alternatives to each other.
-  Rename With this menu item it is possible to rename (change the displayed name) a selected operating device. Renaming can be done in the same way by double-clicking the left mouse button on the corresponding operating device in the list or by pressing the "F2" key.
-  This menu item is not available when selecting several operating devices.
-  The context menu of the operating devices found cannot be called up if the function "Selected devices flash automatically" is executed. It is then possible to rename the operating devices found by double-clicking the left mouse button on the operating device in the list or by pressing the "F2" key.

In the display area for projected groups and single devices (G), another separate context menu is available for each element. Operating functions can be executed via this context menu. The context menu is called up when a group or an single device is selected in the display area and then the right mouse button is clicked.

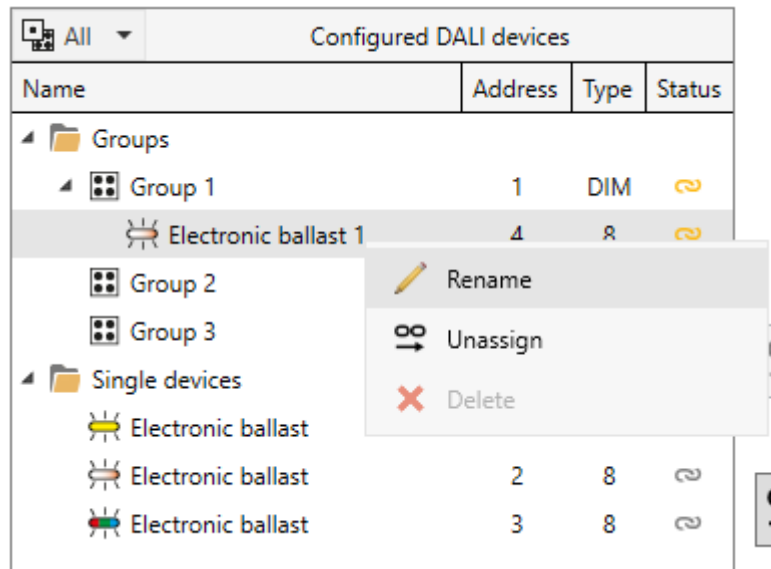

Figure 64: Example of a context menu for configured groups and single devices

- ✎ **Rename**

With this menu item it is possible to rename (change the displayed name) a selected group or an single device. Renaming can be done in the same way by double-clicking the left mouse button on the corresponding element in the list.

i Renaming groups and single devices also has an effect on the projected designations in the standard parameter dialogue of the gateway. The changes are adopted here in the same way.
- 🔗 **Unassign**

This command removes an existing assignment to a found operating device. The operating device concerned then moves back to the right-hand display area (H) without being assigned.

i This menu item is only available when selecting a projected single device or a virtual device within a group.
- ✖ **Delete**
 Delete unassigned ECGs

This menu item removes either a virtual device created in a group ("Delete") or all virtual devices created in a group ("Delete unassigned ECGs"). Deletion is only possible if the virtual devices are not assigned to any operating devices found.

i These menu items are only available when selecting an unassigned virtual device within a group, or when selecting a group that has unassigned virtual devices.

Make devices flash automatically

After searching for operating devices in a DALI system in the course of commissioning, it is usually necessary to identify the devices, i. e. to recognise and log their installation or effective location. The function "Selected devices flash automatically", which can be activated via the slide switch of the same name, can help here.

When the function is activated, the operating devices selected in the right-hand display area (H) flash automatically. The selected operating devices are then switched on and off cyclically by the gateway. The switching state changes approx. once a second. During the flashing process, the device symbols in the display area of the DCA also flash. As soon as the selection is changed with the mouse or keyboard, the flashing stops for the devices that are no longer selected. Only the devices that have been selected in the display area flash. By using the arrow keys on the keyboard, operating devices can be selected quickly and clearly and identified in the DALI system.

- i** If the function "Selected devices flash automatically" is activated, it is possible to rename the operating devices found by double-clicking the left mouse button on the operating device in the list or by pressing the "F2" key.

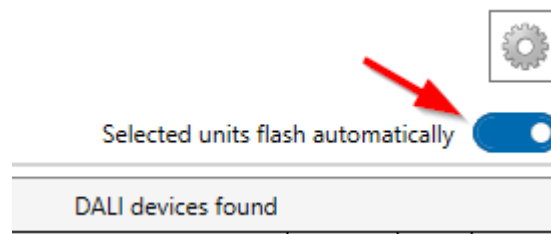

Figure 65: Toggle button "Selected devices flash automatically"

The flashing process remains active until the function is deactivated again via the toggle button. The function is also automatically deactivated as soon as another available DALI online function is selected in the DCA.

- i** When executing the function "Selected devices flash automatically", the DCA keeps a communication connection to the gateway via the KNX open via the ETS so that the switching state can be changed cyclically. The DCA reports an error and automatically deactivates the function if the communication to the gateway is disturbed.

Assign names

In the display areas (G) and (H), groups, single devices and found DALI operating devices are displayed. These elements have editable names for better identification in the DCA.

The names of configured groups and single devices (left display area) are derived from the parameter configuration of the application program. In the standard parameter dialogue of the ETS, the names are specified by the "Designation" parameters (e.g. "Group" and "electronic ballast"). Operating devices found that are listed in the right-hand display area after a successful DALI device search are given a preset technical name (e.g. "Electronic ballast 1", "Electronic ballast 2") that can be edited subsequently and adapted by a descriptive name if required.

It is possible to change the group and single device names or the names of the operating devices in the DCA by selecting the "Rename" command in the context menu of the element (right mouse click). Alternatively, names can also be edited by double-clicking (left mouse button). Names of group and single devices that have been changed in the DCA are also adopted in the same way in the parameter dialogue of the ETS.

Operating devices found in the right-hand display area can have a technical name (e.g. a designation from an installation plan for marking and identifying the electronic ballast directly during a device search) or a descriptive name that usually also corresponds to the projected designation (e.g. the designation from a visualisation for the user of the installation). The name used in the right-hand display area of the commissioning dialogue of the DCA usually depends on the wishes of the ETS user or the planner and allows individual procedures for your DALI commissioning.

The setting "Use single device designation" in the context menu of the DALI commissioning dialogue defines the following rules when displaying and assigning found operating devices:

- "Use single device designation" deactivated (default):
The technical name of any operating devices found is shown in the right-hand display area. The name can be edited by double-clicking or via the context menu (right mouse click). The technical name is persisted and not overwritten by an assignment to projected single devices. It can therefore be indicated again at any time if the option "Use single device designation" is deactivated.
- "Use single device designation" activated:
The speaking name of operating devices found is shown in the right-hand display area. Here, too, the name can be edited by double-clicking or via the context menu (right mouse click). When assigning to configured single devices, the speaking name is always replaced by the name from the parameterisation of the single device. The last speaking name edited in the right display area before the assignment is therefore overwritten by an assignment.

When assigning to groups, the virtual devices created in the groups are always given the name of the operating devices found, which is visible in the right-hand display area. Depending on the option "Use single device designation", either the technical or the speaking name is then also displayed in the left display area for the virtual devices. The name of an operating device is also transferred to a virtual device if it was already created in a group by an earlier assignment and is only linked to another operating device.

-  The setting "Use single device designation" can be switched at any time as desired. The technical name always remains. The speaking name is replaced by the projected name as described. Before renaming operating devices that have been found, the ETS user should always pay attention to which display mode the DCA is in order to avoid unintentional changes to names that have already been assigned.

11.1.2 Performing DALI commissioning

Introduction

During DALI commissioning, the max. 64 DALI operating devices of a DALI system are assigned to the programmed groups or single devices of the gateway. Only this assignment creates the option of controlling the DALI operating devices individually or jointly via the KNX. The "Addressing type" configured in the parameter dialogue determines whether group and/or single device control is possible.

Any number of DALI operating devices can be assigned to groups 1...16. On the DALI side, addressing takes place using group addresses, which the gateway configures automatically and manages on its own. During DALI commissioning, the operating devices concerned are programmed accordingly. In contrast, only up to five DALI operating devices are to be assigned to groups 17...32. Since there are no DALI group addresses for these groups, DALI addressing takes place using the device short addresses, which means that the operating devices are addressed, and thus contacted, individually.

Alternatively, DALI operating devices can be addressed as single devices. The addressing of these devices takes place individually using the device short addresses.

-  DALI operating devices can either be integrated only in single device addressing, or alternatively, in group addressing. It is not possible to control an operating device with both addressing types. Operating devices integrated in group control can no longer be addressed as a single device. The reverse case applies in the same manner.

11.1.2.1 Device search

Searching for DALI operating devices

During initial commissioning, the connected DALI operating devices of a DALI system must be searched for and identified. If the DALI gateway has been commissioned at least once before, searching for operating devices is only necessary if new devices have been added to the DALI system or if changes have occurred in the existing DALI installation (e.g. electronic ballast replaced). At the end of DALI commissioning, the commissioning parameters (identified operating devices with long and short address, names of the operating devices, group/device assignment and device type) are written to the ETS database and are thus saved. The saved data is displayed when the DALI commissioning environment is started.

During initial commissioning, no DALI operating devices are displayed in the right display area (B). To continue commissioning, the operating devices connected to the DALI cable must first be searched for. The devices affected must be connected to the DALI cable and operational in order for the gateway to be able to find and identify all necessary DALI operating devices during the device search. In addition, the mains voltage supply of the gateway must be switched on.

- Click on the "Search for devices" button (C) in the DALI commissioning environment.

The gateway searches for available DALI operating devices. In so doing, the gateway scans the DALI cable in stages and identifies the connected devices successively. Depending on the number of connected operating devices, the search operation may take some time.

- i** During the search operation, the gateway tells the DALI operating devices to create a random long address internally. This only takes place for devices which were identified as "New devices found" at the beginning of the search operation. In addition, the gateway already assigns short addresses in the background during the search process, which are then adapted using group and device assignments in the course of commissioning and can thus be overwritten.

The DCA uses the long addresses to distinguish between the found operating devices being detected for the first time and those devices which were previously detected during commissioning. For this, the DCA compares the read-in long addresses with the entries saved in the ETS database. Previously unknown long addresses indicate newly found operating devices.

Taking this distinction into account, the DCA displays the newly found electronic ballasts in the search progress. During the first DALI commissioning, all operating devices found are counted under "New devices found". In later commissioning operations, only those operating devices are indicated as newly found, which were added to the DALI system.

- i** According to the DALI specification, all the DALI subscribers must save the long address permanently (e.g. even during mains voltage failures). Not all the DALI devices on the market support this requirement. If such operating devices are installed, compatibility mode should be activated. During a search operation, the gateway then identifies operating devices solely by means of the DALI short address (1...64) contained in the devices. This means that operating devices can be commissioned without accessing long addresses.
- i** In the event of an installation error (display "Er" in the 7-segment display) or a short circuit, the gateway attempts to establish a DALI communication. If this does not succeed, the gateway aborts the process and displays an error message. DALI operating devices are not detected if there is a cable break, for example.

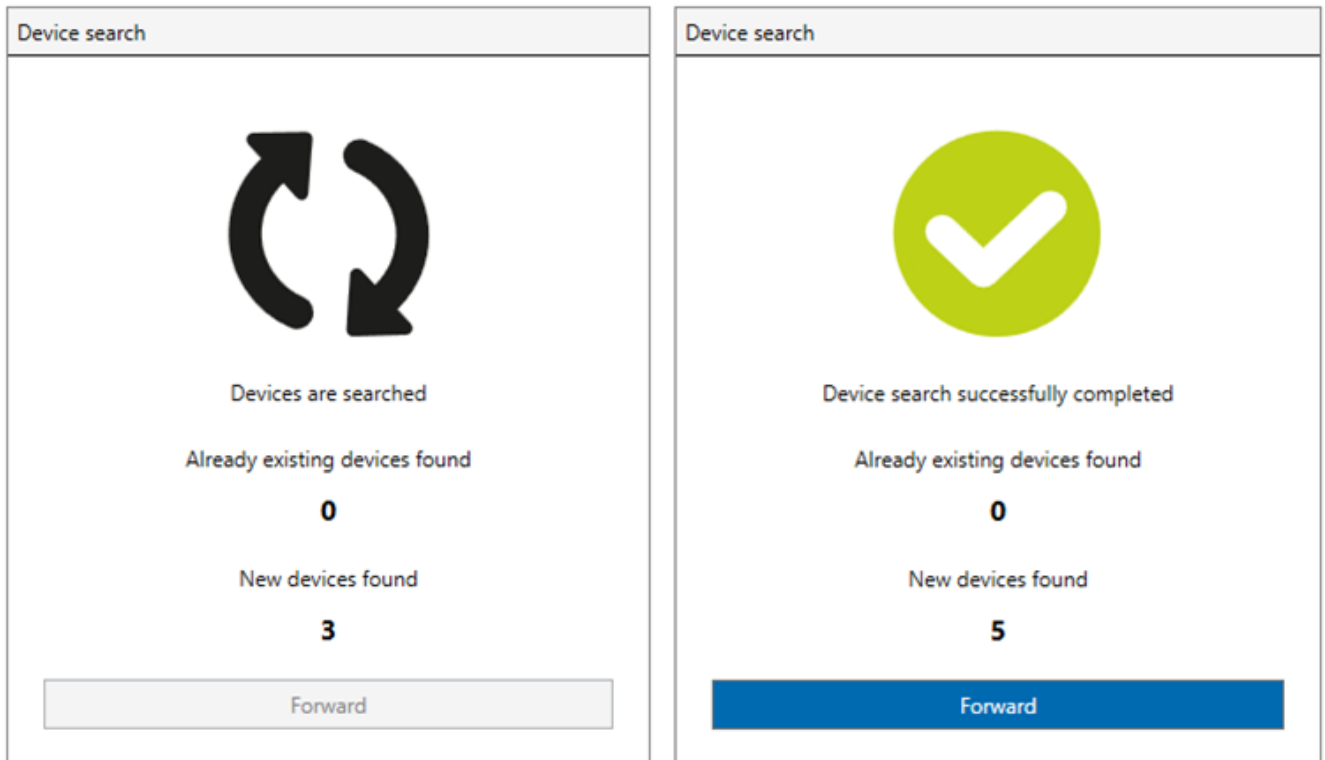

Figure 66: Example of search progress for a DALI control gear search (left) and finished search result (right)

After completion of the search operation, all the identified operating devices (both old and new) are listed in the right display area (H) of the commissioning environment.

- i** If the gateway has not found any new participants when searching for operating devices, the DCA displays an error message as a result. A device search should only be carried out if further operating devices have been added to the DALI installation, existing devices have been replaced or removed from the installation.

DALI devices found				
No.	Name	Address	Type	Status
1	Electronic ballast 1	-	8	
2	Electronic ballast 2	-	6 8	
3	Electronic ballast 3	-	0	
4	Electronic ballast 4	-	6 8	
5	Electronic ballast 5	-	6 8	

(J) (K) (L) (M) (N)

Figure 67: Example of a device list after a search operation



- (J) Sequence number of the operating devices found (1...64)
- (K) Name of the operating devices found incl. symbol for device type
- (L) Assigned short addresses (for unassigned operating devices undefined "-")
- (M) Device type (digit of the DALI device type)
- (N) Status of the assignment

The identified DALI device types of the operating devices found are shown in the display window as digits (M) for reasons of space. The numbers are directly derived from the possible DALI device types. A combination of several device types is a multifunctional operating device that allows several uses.

DALI device type	Use
DT0	Ballast for fluorescent lamps
DT2	Ballast for discharge lamps
DT3	Ballast for LV halogen lamps
DT4	Ballast for Incandescent lamps
DT6	LED driver
DT7	only switchable ballast
DT8	Ballast for colour temperature or colour control
z. E.G. DT6.8	Multitype: e.g. use as LED driver or ballast for Colour-Control

-  The DCA displays the use of the device type in plain text when the mouse is moved to a digit.

The DCA shows the status of operating devices (N) found in the form of symbols in the display window. Devices can be assigned either to projected groups or single devices in the left display window. The symbols have the following meaning:

-  Not assigned The operating device is not yet assigned to a group or an single device. It can only be controlled via the DALI test of the DCA and cannot be operated via KNX communication objects.
-  Commissioning not completed The operating device is assigned to a group or an single device, but the DALI commissioning has not yet been completed. The control gear can only be controlled via the DALI test of the DCA and cannot be operated via KNX communication objects.
-  Put into operation The operating device is assigned to a group or an single device. The DALI commissioning has been fully completed. The control gear can be controlled via the DALI test of the DCA and, after programming the application program with the ETS, also via KNX communication objects.

-  The DCA displays the status in plain text when the mouse is moved over a symbol.

-  The status of the operating devices that have been assigned to a configured DALI group is indicated in the right-hand display area of the DALI devices found only if the "Allow multiple group assignment" checkbox has been selected in the context menu of the DALI commissioning dialogue. Otherwise (checkbox deselected - normal case), operating devices already assigned to the groups are hidden in the right-hand display area. Operating devices that have been assigned to configured single devices are generally not visible in the right-hand display area. "-" is displayed as the short address for all unassigned operating devices.

During a device search, all connected operating devices of a DALI system can switch on to minimum brightness. This makes it possible to determine whether the devices are actually functioning and react to the device search. If necessary, the automatic switch-on to minimum brightness can be switched off. This is useful, for example, if a DALI system is in operation and electronic ballasts that have already been installed and put into operation should not react to a device search.

The behaviour of the brightness during a device search can be set via the context menu  of the DALI commissioning environment:

- Select the "Brightness adjustment device search" checkbox (default setting)
The operating devices connected to the DALI system automatically switch to minimum brightness at the beginning of a device search. After a device search, the brightness can be changed again via the normal operating functions of the gateway.
- Deselect the "Brightness adjustment device search" checkbox

The operating devices connected to the DALI system do not automatically switch to minimum brightness at the beginning of a device search. The devices remain in the last preset brightness state.

11.1.2.2 Group assignment

Introduction

After searching for and identifying the operating devices, the devices can be assigned to the projected groups or single devices. The following sections document the individual actions to be taken to create a group assignment in the DALI commissioning environment.

- i** The assignment of DALI operating devices to groups is only then possible when the addressing type allows for group control.

Basically, an assignment is made by moving the operating devices found listed in the right display area to the left display area. The assignment is made by selecting the elements to be linked and then pressing the buttons  between the two display areas. Alternatively, an assignment is also possible with the help of the mouse by "drag and drop".

An assignment can be cancelled again by selecting an assigned operating device in the left display area and moving it back to the right display area of the existing DALI devices using the button  or the mouse. It is possible to assign multiple operating devices simultaneously, or to remove them from an assignment.

- i** Multiple operating devices can be assigned to Groups 1...16. Only up to five DALI operating devices can be assigned to groups 17...32.
- i** The number of configured groups can be set in the ETS parameter dialogue. If the number of groups is reduced after a DALI commissioning and as a result assignments to DALI control gears become invalid, the DCA identifies this condition the next time it is called up (via the "DCA" tab), removes the assignment of the affected devices in the commissioning dialogue and then requests a new DALI commissioning. The addition of further, previously unassigned groups in the ETS parameter dialogue is possible at any time and without retroactive effect to DALI commissioning that has already taken place.

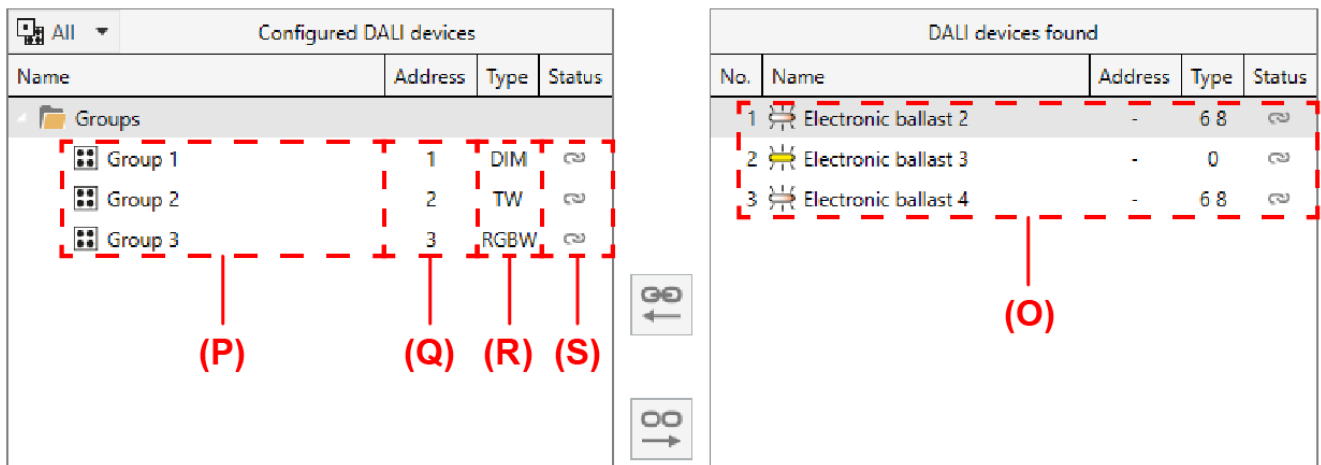

Figure 68: Example of projected DALI groups in the left display area

- (O) DALI operating devices found with DALI device type
- (P) Configured DALI groups from the parameter configuration incl. names
- (Q) Group addresses (automatically assigned)
- (R) Functional scope of the groups (group type)
- (S) Status of the group assignments (all operating devices assigned to the group)

When assigning DALI operating devices to groups, the DCA always automatically checks the DALI device type. Here, the device type transmitted by the operating devices is compared with the functional scope of the individual groups. The DCA only establishes an assignment if compatible device types correspond to the scope of functions (e.g. scope of functions group = "Brightness + Colour RGB" -> compatible device type must be "DT8", colour type must correspond to "Colour Control"). This prevents functional errors after commissioning.

If the functional scope of a group only provides for brightness control, all available DALI device types can be linked to this group.

Scope of functions groups	Group type	Compatible DALI device types	Use
Brightness	DIM	all	only control the brightness
Brightness & colour temperature	TW	only DT8 with colour type "colour temperature (Tc)	Control of brightness and colour temperature
Brightness & colour RGB	RGB	Only DT8 with colour type "Colour Control (RGB-WAF)**"	Control the brightness and colour in the RGB colour space
Brightness & colour RGBW	RGBW	only DT8 with colour type "Colour Control (RGBWAF)**"	Control brightness and colour in the RGBW colour space

- i** *: DALI operating devices of DT8 device type must correspond at least to the "Colour Control RGB" colour type. The extended DALI colour types "WAF" (White [W], Amber [A], Freecolour [F]) can be assigned, but these are not supported.
- i** **: DALI operating devices of the DT8 device type must correspond at least to the "Colour Control RGBW" colour type. The extended DALI colour types "AF" (Amber [A], Freecolour [F]) can be assigned, but these are not supported.

Virtual devices

Each operating device found requires a virtual device to be assigned to a group in the left-hand display area. Consequently, for each group assignment of an operating device, there is always a virtual device below a group. There are two options for assigning operating devices to a group:

- Group assignment by creating a new virtual device in a group:
Assigning to a group automatically creates a new virtual device in the group (e.g. (U)). To do this, assign the operating device directly to the group. The DCA automatically assigns the first free short address to the new virtual device. The DALI device type is set according to the specification of the found operating device.
- Group assignment to a free, already existing virtual device in a group:
If the assignment to an operating device is removed in the left display area in an existing virtual device, the virtual device remains in the group (e.g. (T)). This is important so that the short address is also retained and can be used for new assignments to the group. However, the device type then becomes free. Any operating devices found from the right-hand display area can then be assigned directly to free virtual devices. The assigned operating device receives the short address of the virtual device through the assignment. The device type is then reassigned.

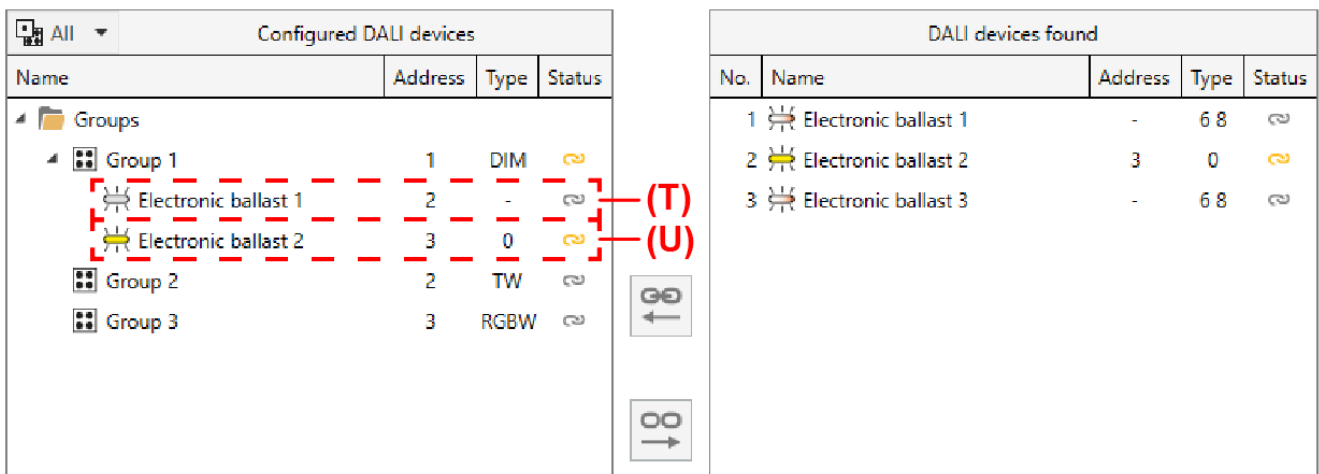

Figure 69: Example of virtual devices of a projected DALI group

- (T) Virtual device with short address (not assigned)
- (U) Virtual device with short address (assigned)

The command "✗ Delete" from the context menu of a virtual device or the command "✗ Delete unassigned ECGs" from the context menu of a group can be used to remove free virtual devices from the configuration. In this case, the short addresses of the affected virtual devices are released again and can be used in other virtual devices or in single devices.

- i** DALI operating devices can either be integrated only in single device addressing, or alternatively, in group addressing. It is not possible to control an operating device with both addressing types. Operating devices integrated in group control can no longer be addressed as a single device. The reverse case applies in the same manner.
- i** Each time it is called up ("DCA" tab) and also when creating new virtual devices, the DCA checks the DALI short addresses already assigned in the project design and prevents configured single devices and virtual devices from having identical short addresses. If short addresses are changed in the project design after DALI commissioning and identical short addresses are assigned to single devices and virtual devices, a new DALI commissioning is required so that the DCA can automatically correct the short addresses.

Special case of multiple group assignment

For special cases, it is possible to assign operating devices for group control to more than just one DALI group. In the standard case, assignment of a DALI operating device is only possible in one device. This makes device assignment clear, and the unique assignment means that there are no group overlaps and, as a result, no influencing of configuration and status values. If required, multiple group assignment can be enabled as an alternative by selecting the checkbox of the same name in the context menu . This means that it is then possible to assign DALI operating devices to more than just one group during commissioning.

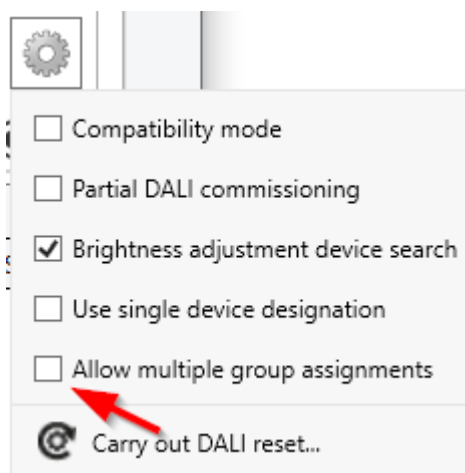



Figure 70: Multiple group assignment in the context menu



- i** DALI operating devices can always be assigned to any group. However, we do not recommend assigning the operating devices to multiple groups on the DALI side. It is better to split the devices up into separate, non-overlapping groups and to create a link on the KNX side using the group addressing in the ETS.

- i** DALI operating devices assigned to multiple groups always set themselves to the most recent status set using one of the assigned groups. In this case, feedback of the switching status or the brightness value of a group may not always be clear.
- i** Each group can be configured independently in the standard parameter dialogue of the ETS. During an ETS programming operation, the individual DALI operating devices are programmed with the parameters of the assigned groups. In so doing, all the operating devices assigned to a DALI group are commissioned identically. If DALI operating devices are assigned to multiple groups, these devices will then receive the project design of the group with the highest group number!

Perform simple group assignment

- If new virtual devices are to be created in a group (e.g. in empty groups), select the desired group in the left display area and one or more DALI operating devices found in the right display area and then assign them by  or by "drag and drop" with the mouse.
If an assignment to already existing and still free virtual devices of a group is to be made, select the desired virtual device in the left display area and only one found DALI control gear in the right display area and then assign it by  or alternatively by "drag and drop" with the mouse.
In the right display area, the assigned operating devices disappear and appear in the left display area for the selected group. The right display area contains only the remaining, not yet assigned operating devices.
- If necessary, assign further operating devices as described.

Perform multiple group assignment

- If new virtual devices are to be created in a group (e.g. in empty groups), select the desired group in the left display area and one or more DALI operating devices found in the right display area and then assign them by  or by "drag and drop" with the mouse.
If an assignment to already existing and still free virtual devices of a group is to be made, select the desired virtual device in the left display area and only one found DALI control gear in the right display area and then assign it by  or alternatively by "drag and drop" with the mouse.
The assigned operating devices appear for the selected group in the left area and also remain in the right display area. Consequently, all assigned and the remaining and not yet assigned operating devices are visible in the right display area.
- Once again, assign one or more available DALI operation devices to an additional group.

If an already assigned operating device has been assigned to another group, the virtual device receives the short address from the other group assignment (an operating device, regardless of whether it has been assigned to a group once or several times, always has only one unique short address). The DCA also displays a "*" after the name of the operating devices concerned.

- If necessary, assign further operating devices as described.

Configured DALI devices				
Name	Address	Type	Status	
Groups				
Group 1	1	DIM		
Electronic ballast 1 *	2	68		
Group 2	2	TW		
Electronic ballast 1 *	2	68		
Group 3	3	RGBW		

DALI devices found				
No.	Name	Address	Type	Status
1	Electronic ballast 1 *	2	68	
2	Electronic ballast 2	-	0	
3	Electronic ballast 3	-	68	

Figure 71: Example for multiple group assignment of a DALI operating device

(V) Multiple assigned DALI control gear

- i** Multiple assignment of an operating device to different groups can only take place if a new virtual device is created by the assignment. No multiple assignment can be set up through the assignment to an existing virtual device. Similarly, multiple assignment to a group in which the operating device is already located is not possible.
- i** It is possible to remove the connection of an operating device, which is assigned multiple times, in a group. Only the assignment for the corresponding group is lost. The virtual device remains in this group and keeps the short address of the multiple assignment! Such virtual devices can subsequently only be linked again with the same operating device of the original multiple assignment.
- i** DALI operating devices can either be integrated only in single device addressing, or alternatively, in group addressing. Operating devices that are assigned to configured single devices no longer appear in the right-hand display area, even if multiple group assignment is active.

11.1.2.3 Single device assignment

Introduction

As an alternative to the assignment of operating devices to groups, it is possible to assign them to the devices of single addressing. The following sections document the individual actions to be taken to create a single device assignment in the DALI commissioning environment.

- i** The assignment of DALI operating devices to single devices is only then possible when the addressing type allows for single device control.

An assignment is also made for single-addressing devices by moving the operating devices found that are listed in the right display area to the left display area. The assignment is made by selecting the elements to be linked and then pressing the buttons between the two display areas. Alternatively, an assignment is also possible with the help of the mouse by "drag and drop".

An assignment can be cancelled again by selecting an assigned operating device in the left display area and moving it back to the right display area of the existing DALI devices using the button or the mouse.

In contrast to the assignment of operating devices to groups, it is not possible to assign multiple operating devices simultaneously or to remove them from an assignment. Each operating device to be assigned requires its own single device in the project design of the gateway so that the short address is unique.

- i** DALI operating devices can either be integrated only in single device addressing, or alternatively, in group addressing. It is not possible to control an operating device with both addressing types. Operating devices integrated in group control can no longer be addressed as a single device. The reverse case applies in the same manner.
- i** The number of projected single devices can be set in the ETS parameter dialogue. If the number of single devices is reduced after a DALI commissioning and as a result assignments to DALI operating devices become invalid, the DCA identifies this condition the next time it is called up (via the "DCA" tab), removes the assignment of the affected devices in the commissioning dialogue and then requests a new DALI commissioning. The addition of further, previously unassigned single devices in the ETS parameter dialogue is possible at any time and without retroactive effect to DALI commissioning that has already taken place.

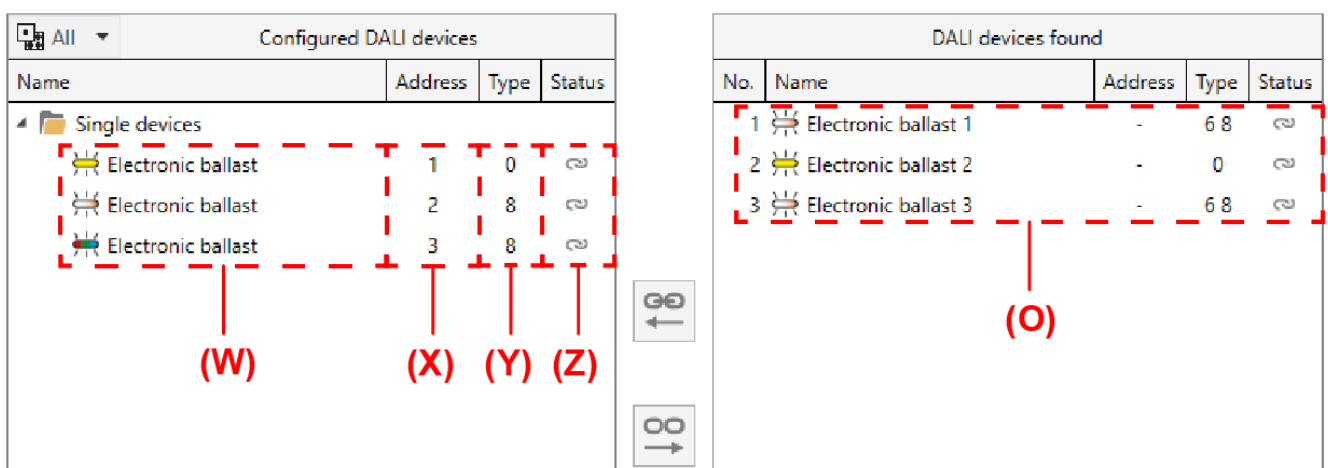

Figure 72: Example of projected DALI single devices in the left display area

- (O) DALI operating devices found with DALI device type
- (W) Configured DALI single devices from the parameter configuration incl. names

- (X) Assigned short addresses from the parameter configuration
- (Y) DALI device types from the parameter configuration
- (Z) Status of the single device assignments

When assigning DALI operating devices to projected single devices, the DCA always automatically checks the DALI device type. Here, the device type transmitted by the operating devices is compared with the projected device type of the single device. The DCA only creates an assignment if the device types are the same (e.g. projected single device = "DT8 (colour temperature)" -> compatible device type of the operating device found must also be "DT8" with the colour type "colour temperature (Tc)"). This prevents functional errors after commissioning.

DALI device type Single device	Compatible DALI device types	Use
DT0 (fluorescent lamp)	only DT0	only control the brightness
DT2 (discharge lamp)	only DT2	only control the brightness
DT3 (LV halogen lamp)	only DT3	only control the brightness
DT4 (incandescent lamp)	only DT4	only control the brightness
DT6 (LED module)	only DT6	only control the brightness
DT7 (switchable only)	only DT7	only control of the switching state (DALI switching actuator)
DT8 (colour temperature)	only DT8 with colour type "colour temperature (Tc)"	Control of brightness and colour temperature
DT8 (colour RGB)	Only DT8 with colour type "Colour Control (RGB-WAF)**"	Control the brightness and colour in the RGB colour space
DT8 (colour RGBW)	only DT8 with colour type "Colour Control (RGB-WAF)**"	Control brightness and colour in the RGBW colour space
Universal	all	only control the brightness

i *: DALI operating devices of DT8 device type must correspond at least to the "Colour Control RGB" colour type. The extended DALI colour types "WAF" (White [W], Amber [A], Freecolour [F]) can be assigned, but these are not supported.

i **: DALI operating devices of the DT8 device type must correspond at least to the "Colour Control RGBW" colour type. The extended DALI colour types "AF" (Amber [A], Freecolour [F]) can be assigned, but these are not supported.

Carry out single device assignment

- Select an single device that has not yet been assigned in the left-hand display area and a DALI operating device found in the right-hand display area and then assign it by or by using the mouse to "drag and drop".

The assigned operating device is removed in the right-hand display area and appears for the selected single device in the left-hand area. The right display area contains only the remaining, not yet assigned operating devices.

- If necessary, assign further operating devices as described.
-  With group addressing, it is possible in special cases to assign operating devices to more than one DALI group. In this case, operating devices already assigned to groups are also displayed in the right-hand display area. Such devices are marked with an "*" after the name.

11.1.2.4 Supplementary functions

Partial DALI commissioning

In the context menu  of the DALI commissioning environment, partial DALI commissioning can be activated and deactivated. The checkbox of the same name influences the DALI device search and also the finalisation process of the DALI commissioning.

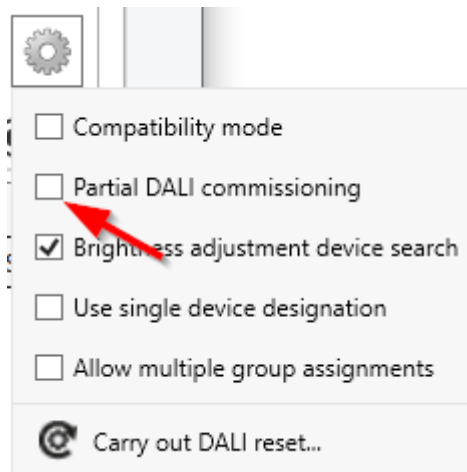

Figure 73: Partial DALI commissioning in the context menu of the DALI commissioning

A distinction is made between the two following cases depending on whether the checkbox is selected or deselected:

- "Partial DALI commissioning" checkbox selected
Operating devices that have already been found during a new DALI device search will be retained even if these do not respond to the gateway (e.g. if the mains voltage supply of these operating devices is switched off or the DALI cable was disconnected). This allows DALI systems to be partially commissioned (e.g. commissioning of multiple construction phases). The DALI commissioning exclusively puts the newly found operating devices into operation. Devices that have already been successfully commissioned are not reprogrammed.
With this setting, make sure that no more than 64 operating devices are connected in the overall extension of the DALI system!

- "Partial DALI commissioning" checkbox deselected (default setting)

In this case, operating devices that have previously been found during a new device search will be removed from the configuration if these devices no longer respond to the gateway. With this setting, ensure that the entire DALI system is switched on and ready for operation. Thus, it is not permissible to switch off previously commissioned operating devices or to disconnect them from the DALI cable. DALI commissioning always recommissions all operating devices of the DALI system, even if known devices have already been commissioned.

During the entire commissioning process, fault-free communication must be guaranteed between the gateway and all DALI operating devices!
- i** Operating devices that have been found cannot be removed from the configuration when using the partial commissioning (checkbox activated). It is only possible to remove operating devices that have already been found by switching back to the standard commissioning (checkbox deactivated) and by executing a new device search for which the previously found devices no longer respond. It should then be ensured that all other operating devices of the DALI system are connected to the DALI cable and are operational! Otherwise, devices will also be removed from the configuration, which should be retained.
- i** When using the partial commissioning (checkbox activated) in conjunction with the compatibility mode, make sure that operating devices that should be partially searched for by a device search and newly added have not already been programmed with an invalid short address. This is the case, for example, if operating devices were already previously commissioned in another DALI system. Ideally, brand new operating devices partially in conjunction with the compatibility mode should only be commissioned. If this is not possible, it makes sense to carry out a DALI reset (resetting operating devices concerned to the delivery state). When doing so, make sure that the reset is only carried out if just the operating devices that should be newly added are connected to the DALI system. Otherwise, the operating devices that were already validly commissioned will be reset.

Compatibility mode

The gateway has a compatibility mode for supporting non-DALI-conformant operating devices. This means that the commissioning process can become distinctly more tolerant towards specific DALI commissioning parameters, which means that operating devices not fully compliant with the DALI specification can be commissioned, possibly subject to functional restrictions.

Compatibility mode is selected when the "Compatibility mode" checkbox is activated in the context menu  of the DALI commissioning environment.

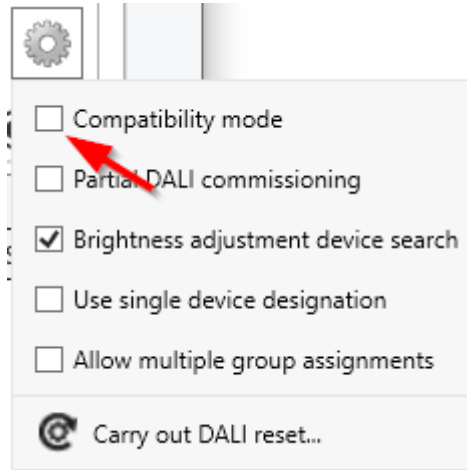

Figure 74: Compatibility mode in the context menu of DALI commissioning

When compatibility mode is active, DALI operating devices in the system are no longer identified using their previously formed long address. Normally (when compatibility mode is deactivated), the gateway uses the DALI long address to check if found operating devices were previously commissioned in a search operation (known device), or whether this is a newly-found operating device. DALI operating devices assign themselves long addresses automatically in the course of a search process according to a random principle. These long addresses are unique in a DALI system, which is why operating devices can be identified individually.

According to the DALI specification, all the DALI subscribers must save the long address permanently (e.g. even during mains voltage failures). Not all the DALI devices on the market support this requirement, which is why difficulties may occur during the commissioning process. If long addresses are lost, the gateway will no longer be able to identify clearly whether found operating devices are known, i. e. already commissioned in previous commissioning operations, or whether they are newly-installed and are thus newly-found devices. In these cases, operating devices are simply identified as "newly-found". As a result, during the remainder of the commissioning process, the affected operating devices are treated like unprogrammed devices. Amongst other things, all the assignments to groups or single devices are removed.

If operating devices are installed in the DALI system, which do not comply with the DALI specification - as described - and do not save the long address correctly, compatibility mode should be activated. During a search operation, the gateway then identifies operating devices solely by means of the DALI short address (1...64). This address was either programmed during a previous commissioning operation by the gateway, in accordance to the project design, or was assigned automatically during a search operation (new electronic ballast).

- i The identification of operating devices becomes problematic if devices are added to the DALI installation at a later time, which were commissioned previously (e.g. in other systems) and thus have already been assigned with valid short addresses. Here, it may occur that different operating devices have the same short address. This state must be avoided when using compatibility mode, since short addresses may only occur once in a DALI installation! Otherwise, communication errors can be expected.



All the commissioning parameters transferred from the gateway are required for correct, fault-free operation of the DALI system and must correspond to the DALI specification. During DALI online commissioning, it may occur that all or some operating devices do not apply the commissioning parameters transferred from the Gateway partially or completely. In order to detect this, the gateway in normal operation checks (compatibility mode deactivated) each programmed change by reading it out and compares the return value of the operating devices with the specifications in the project design (DALI verify). If differences are detected here among short addresses or group assignments to be programmed, the DCA signals an commissioning error.

DALI operating devices that could only be programmed with errors during the DALI online commissioning can work according to their function after commissioning is complete. These DALI operating devices possibly do not comply or only partially comply with DALI, however.

If commissioning errors occur repeatedly, the compatibility mode can be activated on an experimental basis. In compatibility mode the gateway does not read back the programmed commissioning parameters during a DALI online commissioning. Operating devices which merely dispense with answering the gateway (DALI verify remains off / but the function is available), can be commissioned in this way without any error display and abort of the programming connection.

- i If short addresses of the operating devices change due to parameterisation or new assignments, the gateway reprograms the addresses in the existing devices in the DALI system. This reprogramming is done via the long address even if compatibility mode is activated, as otherwise there would be duplicate short addresses in the DALI system at the moment of programming. Operating devices that have not permanently stored the long address cannot then be reprogrammed to other short addresses without interference. In this case, a new device search must be carried out to completely recommission the affected operating devices.

Carry out DALI reset

A global reset of the selected DALI system can be carried out via the context menu  of the DALI commissioning environment. With a DALI reset, all devices of the DALI system are reset to the delivery state defined by the manufacturers. In this operation, all the assignments to groups and single devices in the electronic ballasts are removed. Furthermore, the long and short addresses in the gateway are deleted and the long addresses in the operating devices are reset. After executing the reset command , the right-hand display area no longer shows any devices found. A new search operation must then be restarted to be able to perform new DALI commissioning.

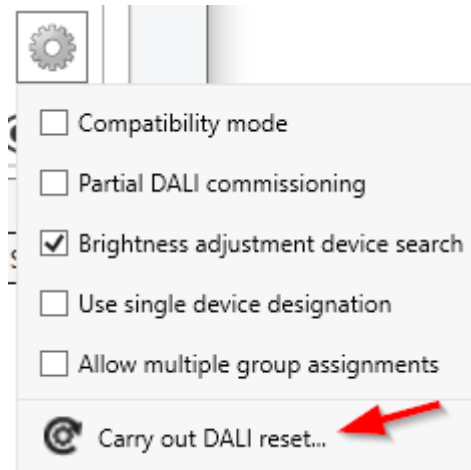

Figure 75: DALI reset command in the context menu of DALI commissioning

A reset should always be carried out with caution and then when previously commissioned electronic ballasts are integrated into DALI systems at a later date or if there are problems in DALI commissioning due to faulty commissioning steps (e.g. undesirable duplicate addresses, communication problems). The DALI reset creates a clean DALI environment as the basis for fault-free commissioning.

- i** It is not possible to reset only individual or a special selection of operating devices within a DALI system.
- i** After a reset of the DALI system, it is always necessary to reload the application program into the gateway with the help of the ETS.

Note on automatic device replacement

With the help of the automatic device replacement of the manual operation, the gateway is able to check a DALI system for completeness of the DALI operating devices that were previously put into operation. If, for example, a defective DALI operating device was removed by an installation engineer and replaced by a new one, the gateway is able to program the new electronic ballast with the programming data of the failed electronic ballast. This makes it possible to replace a failed DALI operating device by a simple operation on the gateway and without any configuration work in the ETS.

The automatic device replacement updates the configuration data (long address) of the replaced DALI operating device initially only in the gateway. To ensure that the change of the DALI configuration is permanently adopted in the ETS configuration, a DALI device search should be carried out again in the ETS (DCA) after executing one or more operations of the automatic device replacement. Through this, although no new operating devices are found, the DCA compares the DALI project planning data between gateway and ETS and saves the change in the ETS project. Only then may new programming operations of the application program be carried out.

- i** If the application program is programmed with the ETS after an automatic device replacement without a subsequent new DALI device search in the DCA, the changes brought about by the device replacement will be lost. In this case, the DCA will display newly found operating devices that are actually not new in future device searches.

11.1.3 Complete DALI commissioning

Introduction

After assigning the DALI operating devices to the groups and single devices, commissioning must be completed in the DALI system concerned. This transfers all DALI settings stored in the ETS project to the gateway and to the DALI operating devices.

When commissioning is completed, the DCA communicates with the gateway via the KNX programming connection of the ETS. The gateway must be connected to the KNX bus cable and the bus and mains voltage supply must be switched on. The ETS must have a functioning communications interface to the KNX (e.g. USB or IP).

- i** Completing a DALI commissioning is only necessary if there have been changes since the last commissioning that need to be transferred to the gateway. The DCA automatically detects changes to the configuration and indicates in the display area (A) of the DALI commissioning environment if a commissioning has not yet been completed.
- i** With the "2-fold" device variant, the completion of the DALI commissioning is required separately in each DALI system.
- i** Each time the DCA is called up (via the "DCA" tab), the configurations saved in the ETS project are displayed in the DALI commissioning dialogue.

Complete DALI commissioning

- To adopt the DALI configuration in the gateway and in the operating devices, the "Complete commissioning" button (C) (see figure 61) must be clicked in the commissioning dialogue in the DCA.

The DCA establishes KNX communication with the gateway via the programming connection. The adjustment of the commissioning configuration is carried out. The adjustment operation can take some time and is dependent on the number of groups and single devices created and the DALI operating devices connected. The DCA displays the progress of this adaptation. First, the DCA programmes the gateway with the device types, the long and short addresses and with other additional information.

Subsequently, the connected DALI operating devices are also updated. To do this, the gateway communicates with the connected operating devices via the DALI cable and programs them fully automatically.

Finally, the group assignments are updated. This takes place in two steps. Firstly, the group assignments are programmed into the DALI gateway. Then they are programmed into the operating devices via the DALI cable.

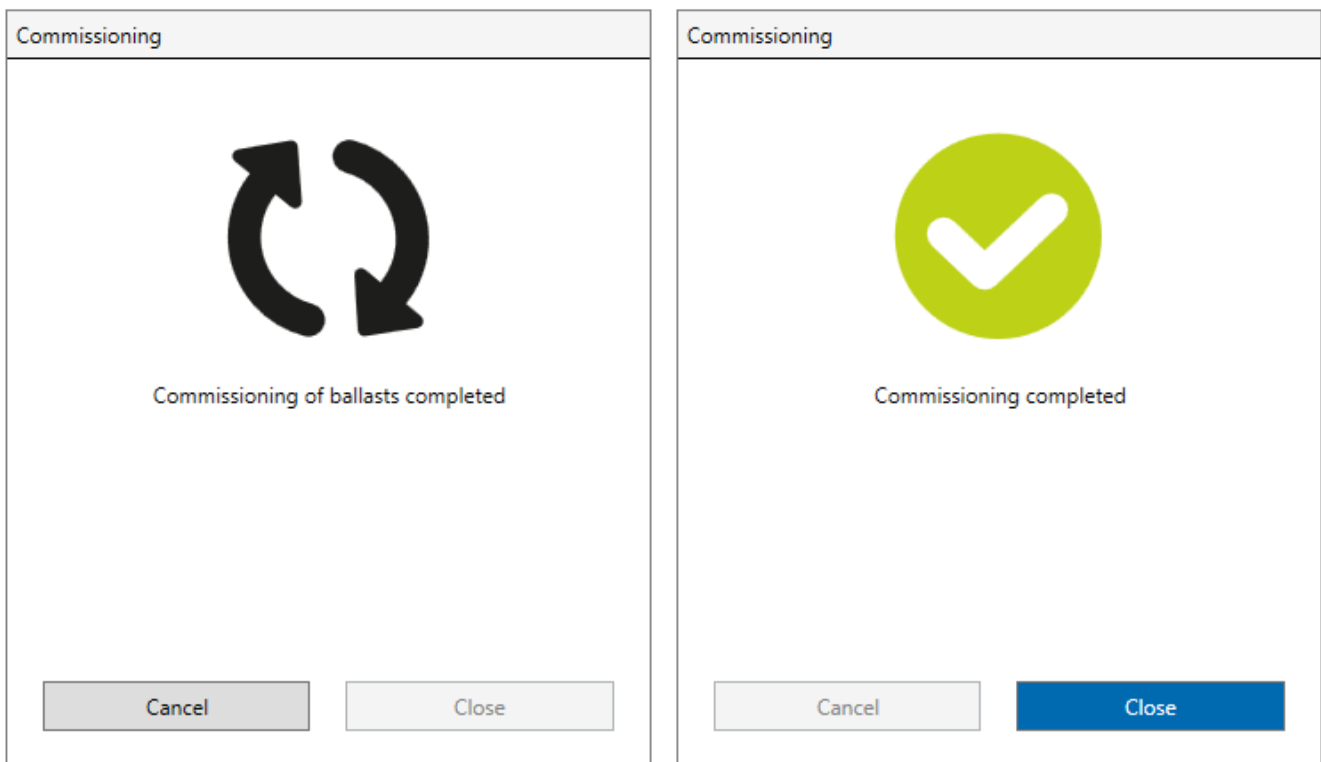

Figure 76: Completion of the DALI commissioning

- To complete the commissioning and to accept all necessary parameters, the application program of the gateway must then be programmed with the ETS.
- i** Unless partial commissioning is activated, DALI commissioning always commissions all operating devices of the DALI system, even if known devices have already been commissioned. Only when partial commissioning is active does the DCA exclusively commission newly found operating devices. Devices that have already been successfully commissioned will not be reprogrammed in this case.
- i** Should commissioning be terminated due to communication or device errors, the DCA will perform a complete programming operation during a subsequent commissioning adjustment. In this case, the completion of the DALI commissioning must be triggered manually in the DCA as described.
- i** The gateway checks the functionality of the DALI line when programming the commissioning configuration into the DALI control gear. Should no communication be possible, the DCA will terminate the operation with an error message. In this case, the fault (e.g. electronic ballast disconnected, mains voltage switched off, line break) must be eliminated and the commissioning procedure must be carried out again. During the programming of the commissioning configuration into the gateway, fault-free communication between the ETS and the gateway must be ensured via the KNX. If the DCA cannot reach the device,

the commissioning process is aborted with an error message. In this case, too, the error must be eliminated and then the commissioning procedure must be carried out again.



11.2 DALI test

Starting DALI test

The DCA of the gateway offers various options for carrying out a comprehensive test of the DALI installation. Thus, after a DALI commissioning in the DALI test, it is possible to control individual operating devices, switch them, read out or preset brightness values or colour temperature or colour values. The single device status can also be displayed. In another test environment, all projected groups (1...32) or single devices (1...64) can be switched separately, changed in brightness value or in colour temperature or colour (if supported by the control gear). In addition, it is possible to check the function of the configured scenes (1...16).

The DALI test can only be performed complete if the device, group and scene configuration in the gateway remains current after DALI commissioning or parameters are changed. For this reason, it is necessary to program the gateway with the ETS before a DALI test if changes were previously made to the device configuration . Only the "All devices (broadcast)" test can be carried out without previous DALI commissioning and without ETS programming after a change in the configuration.

If the described prerequisites are fulfilled, the "DALI Test" can be called up via the tab of the same name or the button in the welcome window of the DCA. After the call, the DALI test environment is visible in the DCA window.

-  The DALI test is available for each DALI system and is carried out separately. Switching between the DALI systems is possible in the test environment for the "2-fold" device version via the "DALI System 1" and "DALI System 2" tabs. For the "1-fold" device variant, only the "DALI System 1" tab is available.
-  When configuring the "Central" addressing type, only broadcast commands (switch all operating devices) can be executed in the DALI test.

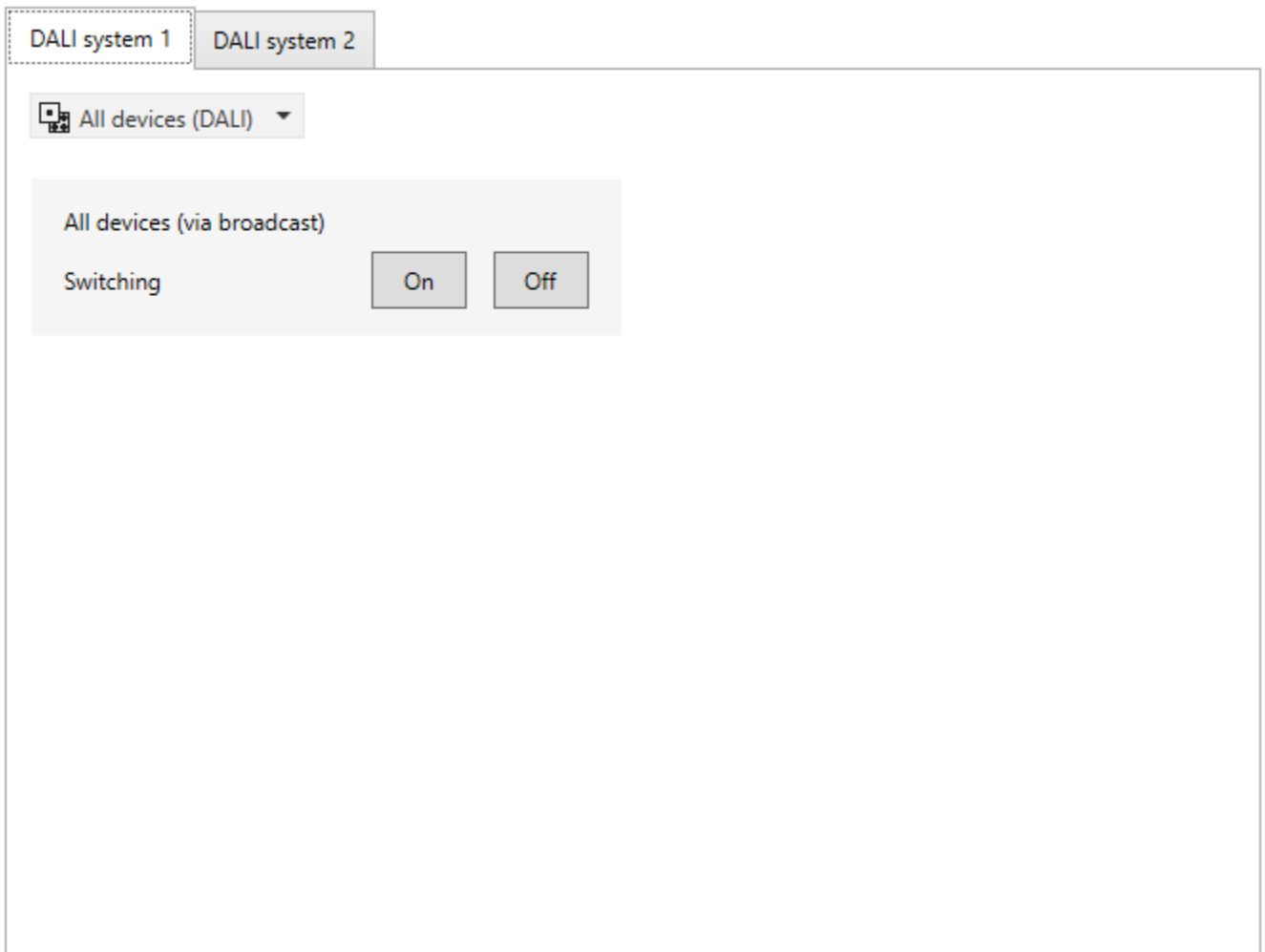

Figure 77: DALI test environment in the DCA

The DALI test requires a functional programming connection from the ETS to the affected gateway in the KNX installation. Before running the test, the DCA first checks whether the ETS can communicate with the gateway via the KNX programming connection (status message "↻ Connection check active"). If this is not the case, no DALI test can be carried out. The DCA then displays a status message in the display area (A).

For an interference-free DALI test, the gateway must be connected to the KNX line and the bus and mains voltage supply must be switched on without interruption. In addition, the ETS must have a functioning communications interface to the KNX (e.g. USB or IP).

If it is not possible to establish a connection to the gateway via the KNX programming interface, the cause must be identified. Reasons for a faulty connection and the appropriate remedies are listed below:

- Cause: No functioning ETS communication interface to the KNX.
Remedy: Check, and if necessary, setup the connection in the ETS.
- Cause: Physical address and application program not previously programmed by the ETS.
Remedy: Exit DCA and then program the physical address and the application program with the ETS.

- Cause: KNX bus voltage at the gateway or at the ETS communication interface not connected or ready for operation.
Remedy: Connect and switch on the bus voltage.
 - Cause: Mains voltage supply on the gateway not switched on.
Remedy: Switch on the mains supply at the gateway.
- i** The gateway detects physical transmission errors on the DALI line (e.g. short circuit) when a test is to be carried out. The DCA then displays an error. Test access to the operating devices is only possible if the DALI system concerned is in undisturbed normal operation. An interrupted DALI line is not detected during the test.

11.2.1 Test "All devices (DALI)"

With the "All devices (DALI)" test, all operating devices connected to a DALI system can be switched on and off together. The gateway uses a DALI broadcast command for this control. With the help of this function, it is possible to test all participants connected to the DALI system quickly and easily, even without DALI commissioning.

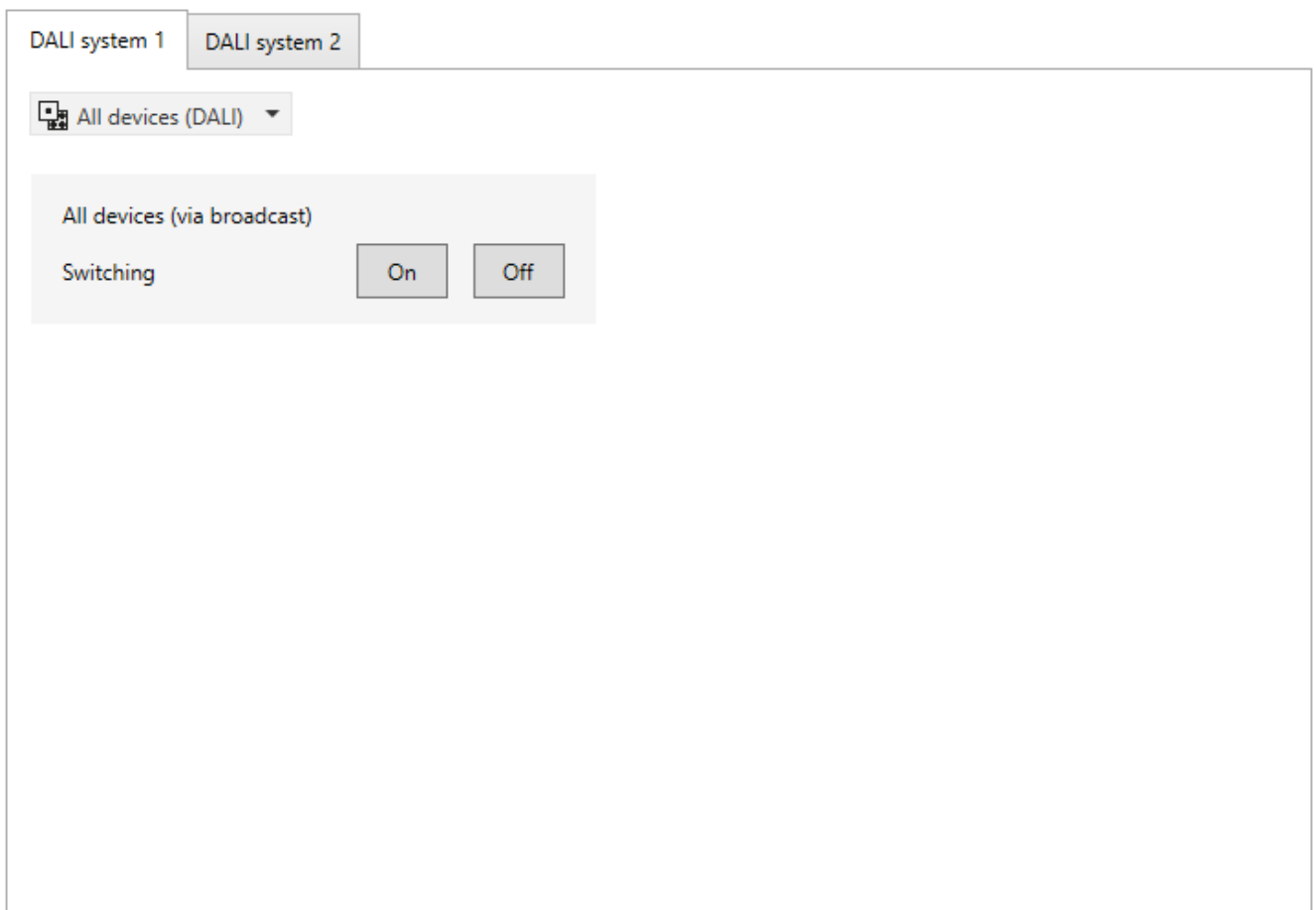

Figure 78: Test "All devices (DALI)"

- i** During the DALI broadcast test, the commands are transmitted to the operating devices directly via the DALI cable. No group assignments or assignments to single-addressed devices are taken into account, which means that group/

device objects cannot be tracked during the test and thus differences may occur between the KNX status objects and the actual states of the operating devices.

11.2.2 Test "Devices (DALI)"

As soon as a DALI commissioning has been carried out and operating devices have been found in the course of this, these devices can be tested for correct function in the device-oriented test "Devices (DALI)". It is not necessary that the devices found have also been assigned to configured groups or single devices.

Figure 79: Example view of the "Devices (DALI)" test

The operating device to be tested must first be selected in the "Select device" selection field. All DALI operating devices found in the course of a DALI device search - identified by the device name - are available for selection here. Only one device can be tested at a time. The selected control gear can then be switched on or off individually and independently of group or single device assignments. In addition, it is possible to specify an absolute brightness value, a colour temperature value or a colour, provided that the control gear supports this function.

When the "Set" button in the "Luminous flux" area is pressed, the brightness value selected in the selection field is transmitted as a DALI Arc-Power-Level to the corresponding control gear, which should then immediately adjust to this brightness value. The brightness value specified at this point is independent of a parameterisation for

minimum or maximum brightness. The whole brightness range can thus be set in the device-orientated DALI test. Similarly, the currently set brightness value of the DALI operating device can be requested by pressing the "Read" button. The read-out value is displayed in the selection box.

When testing a DALI control gear of the device type "DT8 - Tunable White (TW)", pressing the "Set" button in the "Colour temperature" area transmits the colour temperature value selected in the selection field to the corresponding control gear. The device should then adjust itself immediately to the specified colour temperature, but only if the lamp is also switched on. The colour temperature value is independent of a configuration for the minimum or maximum colour temperature. Thus, the entire colour temperature range can also be set here in the device-orientated DALI test. Similarly, the currently set colour temperature value of the DALI operating device can be requested by pressing the "Read" button. The read-out value is displayed in the selection box.

If the DALI control gear to be tested is of the device type "DT8 - Colour Control", a test of the colour setting can be carried out. When the "Set" button in the "Colour" area is pressed, the colour value selected in the selection field is transmitted to the corresponding operating device. If the control gear corresponds to the "RGBW" colour space, the white value can be tested in addition to the colour. When a value is set, the device immediately adjusts to the specified colour, but only if the lamp is also switched on. Similarly, the currently set colour/white value of the DALI operating device can be requested by pressing the "Read" button. The read value is displayed in the selection field or in the slider of the white value.

- i** When specifying a colour temperature or colour value, the brightness value set in the test environment for the operating device is always also transmitted to the assigned operating device. During the transmission of a colour temperature or colour with the brightness value "0 %", the operating device does not normally show any reaction.
- i** The values read in by the "Read" function may deviate from the default values due to rounding.
- i** Specifying or reading out a colour temperature or colour is only possible with operating devices that support the DALI device type "DT8" in either the specific "Tunable White (TW)" or "Colour Control (RGBWAF)" version. During a device search in the course of a DALI commissioning, the DCA determines the type of device supported by the control gear and only offers the settings supported by the device in the DALI test environment.

By pressing the "Read" button in the "Device status" category, it is possible to display the internal states of the selected operating device. In this way, the general device status (operating device error, e.g. internal electronic ballast error), the lamp status (e.g. defective lamp, line break to the lamp socket), the current switching status, information on whether projected brightness limit values have been violated or whether

the operating device is in a fading dimming process, the reset status, information on the validity of the short address and the status of the mains voltage supply can be evaluated and displayed.

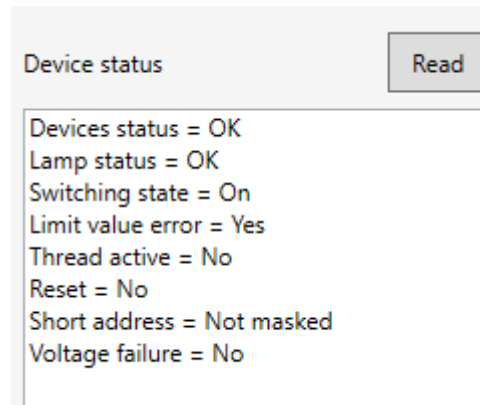

Figure 80: Example for device status

- i** Some status information depends on the DALI control gear used. Not all devices track these states.
- i** During the test "Devices (DALI)", the commands are transmitted to the operating devices directly via the DALI cable. No group assignments or assignments to single-addressed devices are taken into account, which means that group/device objects cannot be tracked during the test and thus differences may occur between the KNX status objects and the actual states of the operating devices.

11.2.3 Test "Groups (KNX)"

As soon as a DALI commissioning has been carried out and the application program has then been programmed with the ETS, the "Groups (KNX)" test can be carried out in the test environment of the DCA. During DALI commissioning, operating devices must have been found and at least one of them must have been assigned to a group.

In the DALI test of the groups, operating devices of a group react with regard to switching and with regard to brightness, colour temperature and colour specifications as provided for by the parameterisation in the ETS. All the actions are implemented internally using the appropriate KNX objects of the groups and single devices. Thus, the internal object values can be read out, for example, when the brightness values are read out and the switching object described internally when a group is switched on. The gateway also generates status telegrams in the KNX system and includes the corresponding DALI group parameters (e.g. dimming behaviour and dimming characteristics).

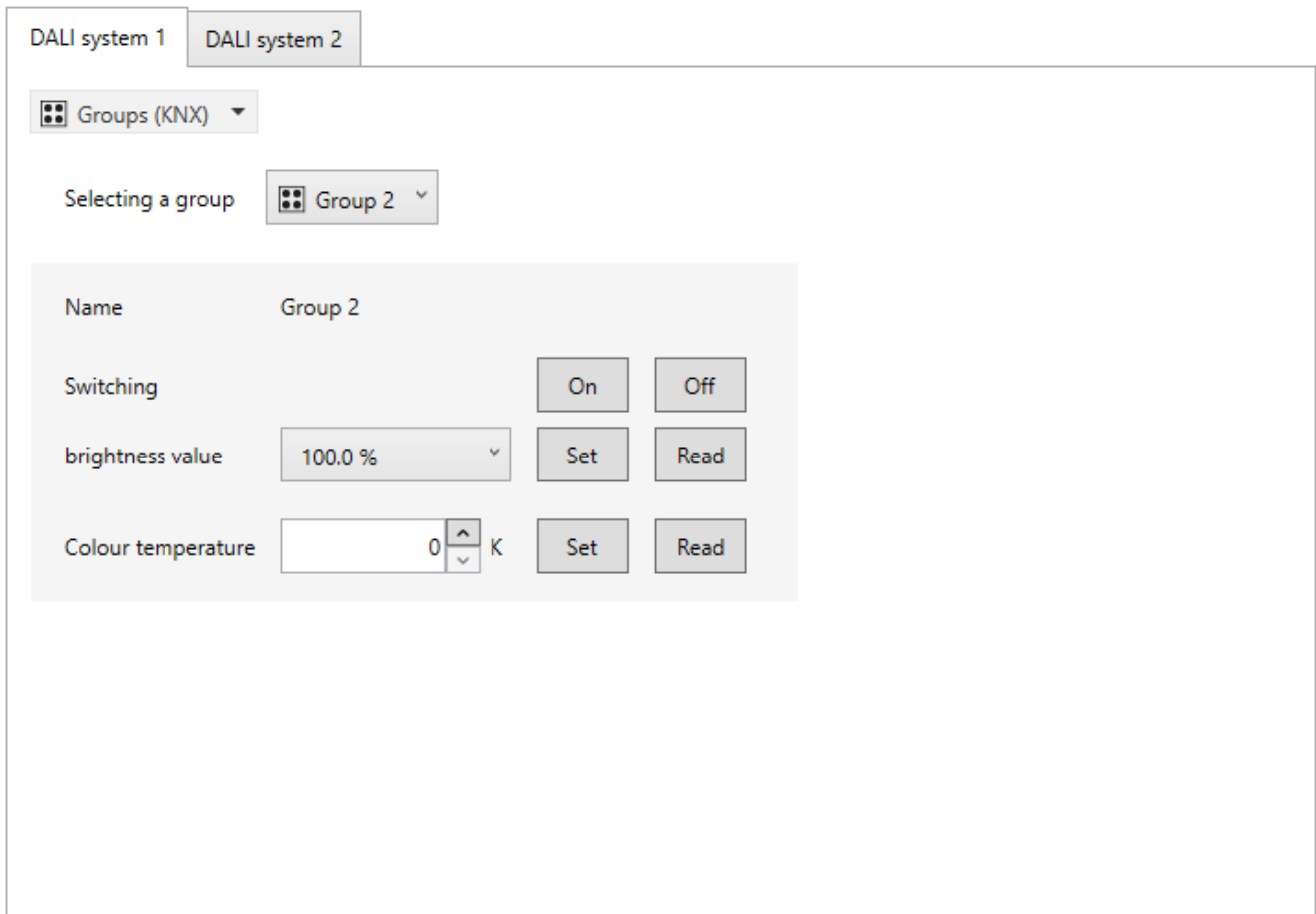

The screenshot shows the 'Groups (KNX)' test interface. At the top, there are two tabs: 'DALI system 1' and 'DALI system 2'. Below the tabs is a dropdown menu labeled 'Groups (KNX)'. Underneath, there is a section 'Selecting a group' with a dropdown menu showing 'Group 2'. Below this, there is a table with the following content:

Name	Group 2	
Switching	<input type="button" value="On"/>	<input type="button" value="Off"/>
brightness value	<input type="text" value="100.0 %"/>	<input type="button" value="Set"/> <input type="button" value="Read"/>
Colour temperature	<input type="text" value="0"/> <input type="button" value="▲"/> <input type="button" value="▼"/> K	<input type="button" value="Set"/> <input type="button" value="Read"/>

Figure 81: Example view of the "Groups (KNX)" test

The DALI group to be tested must first be selected in the "Select group" selection field. Here, only those groups - identified by the group names - are available for selection to which operating devices were also assigned in the course of a DALI commissioning. Only one group is testable at a time.

In the DALI test of the groups, each group can be switched on or off independently. Pressing the buttons "On" or "Off" causes immediate switching of the operating devices assigned to the appropriate group.

Alternatively, an absolute brightness value can be specified, which is transmitted to the group by pressing the "Set" button. The brightness value that can be set in the test environment is not dependent on the group parameterisation for minimum or maximum brightness. The full brightness range can therefore be set in the group-oriented DALI test. However, the operating devices of the group observe the parameterisation of the groups and react accordingly in a restricted manner. This allows the parameter configuration and all KNX status messages to be checked without directly triggering KNX telegrams in the installation on input objects.

Similarly, the currently set brightness value of the group can be polled by pressing the "Read" button. The read group value is displayed in the selection field. Due to rounding, the displayed value may deviate from that most recently specified.

When testing a group from the "Brightness & Colour Temperature (DT8)" function range, pressing the "Set" button in the "Colour Temperature" area transmits the colour temperature value selected in the selection field to the corresponding group. The devices in the group should then immediately adjust to the specified colour temperat-

ure, but only if the lamps are also switched on. The colour temperature value is also independent of a configuration for the minimum or maximum colour temperature. So here, too, the entire colour temperature range can be set in the group-oriented DALI test. Similarly, the currently set colour temperature value of the group can be requested by pressing the "Read" button. The read group value is displayed in the selection field.

If the group to be tested is "Brightness & Colour RGB (DT8)" or "Brightness & Colour RGBW (DT8)", a test of the colour setting can be performed. When the "Set" button in the "Colour" area is pressed, the colour value selected in the selection field is transmitted to the corresponding group. If the group corresponds to the colour space "RGBW", the white value is testable in addition to the colour. When setting a value, the group immediately adjusts to the given colour, but only if the lamp is also switched on. Similarly, the currently set colour/white value of the group can be requested by pressing the "Read" button. The read value is displayed in the selection field or in the slider of the white value.

- i If only a colour temperature or colour value is specified, the brightness value set in the test environment for the group is not transmitted to the assigned operating devices if the group is already switched on. When transmitting a colour temperature or colour with the switching state "OFF", the operating devices of the group usually show no reaction unless the group is to switch on in the "OFF" state when a colour temperature or colour is specified (configurable function of the group). In this case, the gateway also transmits the configured switch-on brightness of the group to the operating devices.
- i The values read in by the "Read" function may deviate from the default values due to rounding.
- i DALI operating devices assigned to multiple groups always set themselves to the most recent status set using one of the assigned groups. In this case, feedback of the switching status, brightness value, colour temperature or colour of a group cannot always be clear.

11.2.4 Test "Single Devices (KNX)"

As soon as a DALI commissioning has been carried out and the application program has then been programmed with the ETS, the "single devices (KNX)" test can be carried out in the test environment of the DCA. During DALI commissioning, operating devices must have been found and at least one of them must have been assigned to an single device.

In the DALI test of the single devices, assigned operating devices - as in the test of groups - react with regard to switching and with regard to brightness, colour temperature and colour specifications as provided for by the parameterisation in the ETS. All the actions are implemented internally using the appropriate KNX objects of the single devices. Thus, the internal object values can be read out, for example, when the brightness values are read out and the switching object described internally when

a single device is switched on. The gateway also generates status telegrams in the KNX system and includes the corresponding DALI single device parameters (e.g. dimming behaviour and dimming characteristics).

Figure 82: Example view of the "Single Devices (KNX)" test

The single device to be tested must first be selected in the "Select single device" selection field. Here, only the single devices - identified by the single device names - to which operating devices were also assigned in the course of a DALI commissioning are available for selection. Only one single device can be tested at a time.

In the DALI test of the single devices, each device can be switched on or off independently. Pressing the "On" or "Off" button immediately causes the operating device assigned to the corresponding single device to be switched.

Alternatively, an absolute brightness value can be specified, which is transmitted to the single device by pressing the "Set" button. The brightness value that can be set in the test environment is not dependent on the single device parameterisation for minimum or maximum brightness. The full brightness range can therefore be set in the single-device-oriented DALI test. However, the single device observes the parameterisation and reacts accordingly in a restricted manner. This allows the parameter configuration and all KNX status messages to be checked without directly triggering KNX telegrams in the installation on input objects.

Similarly, the currently set brightness value of the single device can be polled by pressing the "Read" button. The read-out value is displayed in the selection box. Due to rounding, the displayed value may deviate from that most recently specified.

When testing an single device of the device type "DT8 (colour temperature)", pressing the "Set" button in the "Colour temperature" area transmits the colour temperature value selected in the selection field to the assigned operating device. The device should then adjust itself immediately to the specified colour temperature, but only if the lamp is also switched on. The colour temperature value is also independent of a configuration for the minimum or maximum colour temperature. So here, too, the entire colour temperature range can be set in the single-device-oriented DALI test. Similarly, the currently set colour temperature value of the single device can be requested by pressing the "Read" button. The read-out value is displayed in the selection box.

If the single device to be tested is of the device type "DT8 (colour RGB)" or "DT8 (colour RGBW)", a test of the colour setting can be carried out. When the "Set" button in the "Colour" area is pressed, the colour value selected in the selection field is transmitted to the corresponding single device. If the single device corresponds to the "RGBW" colour space, the white value can be tested in addition to the colour. When a value is set, the single device immediately adjusts to the specified colour, but only if the lamp is also switched on. Similarly, the currently set colour/white value of the single device can be requested by pressing the "Read" button. The read value is displayed in the selection field or in the slider of the white value.

- i If only a colour temperature or colour value is specified, the brightness value set in the test environment for the single device is not transmitted to the assigned operating devices if the single device is already switched on. When transmitting a colour temperature or colour with the switching state "OFF", the operating device usually shows no reaction unless the single device is to switch on in the "OFF" state when a colour temperature or colour is specified (configurable function of the single device). In this case, the gateway also transmits the configured switch-on brightness of the single device to the operating devices.
- i The values read in by the "Read" function may deviate from the default values due to rounding.

11.2.5 Test "Scenes (KNX)"

As soon as scenes have been created in the parameter configuration of a DALI system and the application program has then been programmed with the ETS, the "Scenes (KNX)" test can be carried out in the test environment of the DCA. Not only the groups and single devices integrated into the scenes can be tested in the scene test. Of more importance is the fact that a scene definition is also possible through saving scene values.

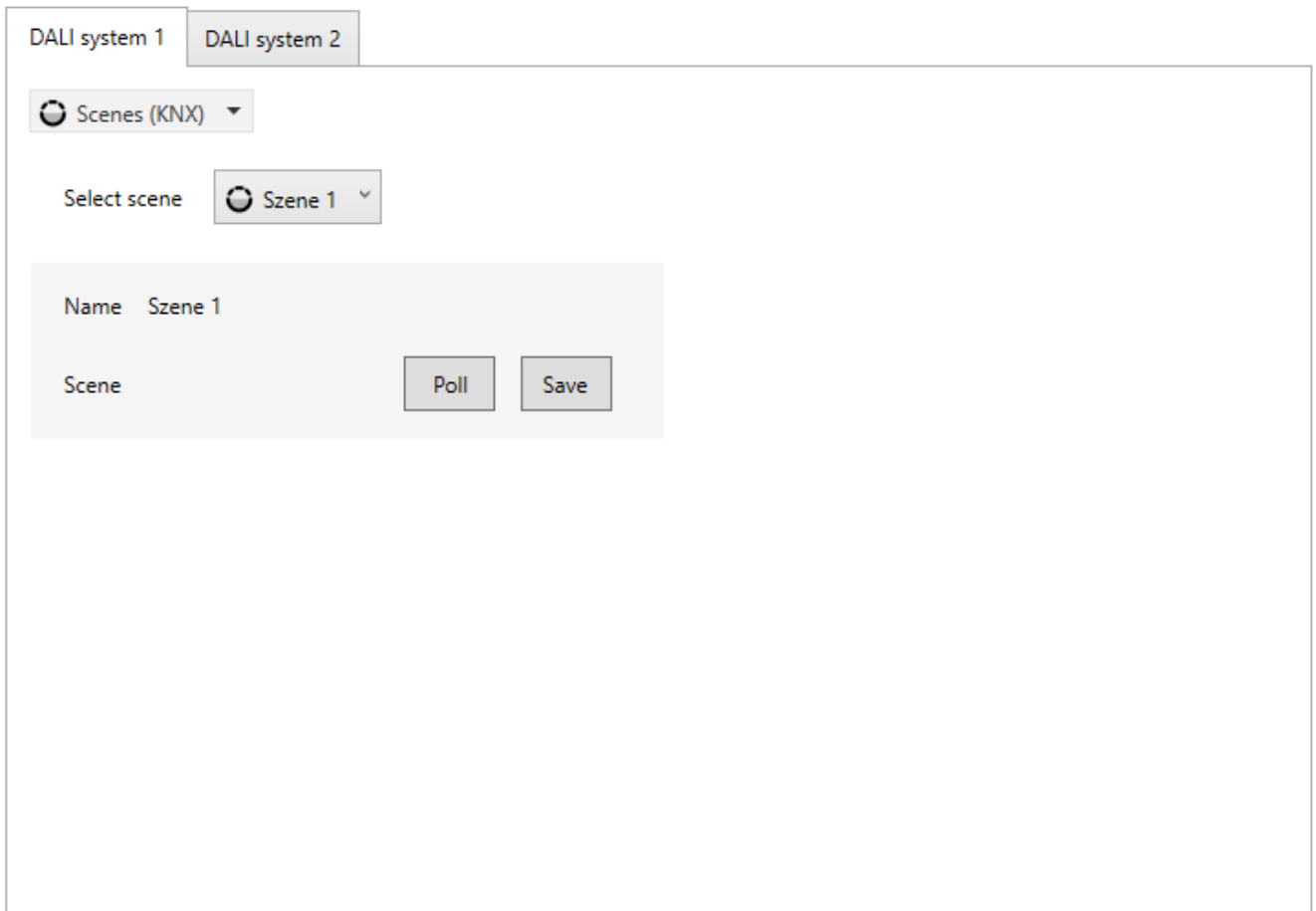

Figure 83: Example view of the "Scenes (KNX)" test

The scene to be tested must first be selected. To do this, select one of the scenes created in the device configuration - identified by the scene name - in the "Select scene" selection field. Only one scene is testable at a time.

Pressing the button "Recall" causes a scene recall with the values predefined in the scene configuration. When the "Save" button is pressed, the gateway executes the save function. Here, all current states of the groups and single devices included in the scene are saved as new scene values, in the same way as if a memory telegram had been received on the scene extension object via the KNX. The original values defined in the scene configuration are overwritten in the gateway.

12 Appendix

Licence information

Copyright (c) 2001-2023 empira Software GmbH, Cologne Area, Germany

Copyright (c) 2005-2018 empira Software GmbH, Troisdorf (Germany)

<http://docs.pdfsharp.net>

MIT License

Permission is hereby granted, free of charge, to any person obtaining a copy of this software and associated documentation files (the "Software"), to deal in the Software without restriction, including without limitation the rights to use, copy, modify, merge, publish, distribute, sublicense, and/or sell copies of the Software, and to permit persons to whom the Software is furnished to do so, subject to the following conditions:

The above copyright notice and this permission notice shall be included in all copies or substantial portions of the Software.

THE SOFTWARE IS PROVIDED "AS IS", WITHOUT WARRANTY OF ANY KIND, EXPRESS OR IMPLIED, INCLUDING BUT NOT LIMITED TO THE WARRANTIES OF MERCHANTABILITY, FITNESS FOR A PARTICULAR PURPOSE AND NONINFRINGEMENT. IN NO EVENT SHALL THE AUTHORS OR COPYRIGHT HOLDERS BE LIABLE FOR ANY CLAIM, DAMAGES OR OTHER LIABILITY, WHETHER IN AN ACTION OF CONTRACT, TORT OR OTHERWISE, ARISING FROM, OUT OF OR IN CONNECTION WITH THE SOFTWARE OR THE USE OR OTHER DEALINGS IN THE SOFTWARE.

Hager Controls
BP10140
67703 Saverne Cedex, France
T +33 (0) 3 88 02 87 00
info@hager.com
hager.com