



LFP2000-A4NMB

LFP Cubic

TDR LEVEL SENSOR

SICK
Sensor Intelligence.



Illustration may differ



Ordering information

| Type | Part no. |
|---------------|----------|
| LFP2000-A4NMB | 1057091 |

Other models and accessories → www.sick.com/LFP_Cubic

Detailed technical data

Features

| | |
|----------------------------|--------------------|
| Medium | Fluids |
| Measurement | Switch, Continuous |
| Design | Standard |
| Probe type | Rod probe |
| Probe length | 2,000 mm |
| Process pressure | -1 bar ... 10 bar |
| Process temperature | -20 °C ... +100 °C |
| RoHS certificate | ✓ |
| IO-Link | ✓ |
| cULus certificate | ✓ |

Performance

| | |
|---|--|
| Accuracy of sensor element | ± 5 mm ¹⁾ |
| Reproducibility | ≤ 2 mm |
| Resolution | < 2 mm |
| Response time | < 400 ms |
| Dielectricity constant | ≥ 5 for rod probe / cable probe ≥ 1.8 with coaxial tube |
| Conductivity | No limitation |
| Maximum level change | ≤ 500 mm/s |
| Deactivated area at process connection | 25 mm ²⁾ |

¹⁾ With water under reference conditions.

²⁾ With parameterized container with water under reference conditions, otherwise 40 mm.

| | |
|---|------------------------------|
| Deactivated area at end of probe | ≥ 10 mm ¹⁾ |
| MTTF | 194.3 years (EN ISO 13849-1) |
| Display | ✓ |

¹⁾ With water under reference conditions.

²⁾ With parameterized container with water under reference conditions, otherwise 40 mm.

Electronics

| | |
|----------------------------|---|
| Supply voltage | 12 V DC ... 30 V DC ¹⁾ |
| Power consumption | ≤ 100 mA at 24 V DC without output load |
| Initialization time | ≤ 5 s |
| Protection class | III |
| Connection type | Round connector M12 x 1, 5-pin |
| Output signal | 1 x PNP + 1 x PNP/NPN + 4 mA ... 20 mA / 0 V ... 10 V |
| Output load | 4 mA ... 20 mA < 500 Ohm at U _v > 15 V, 4 mA ... 20 mA < 350 Ohm at U _v > 12 V, 0 V ... 10 V > 750 Ohm at U _v 14 ≥ V |
| Hysteresis | Min. 2 mm, free adjustable |
| Output current | < 100 mA |
| Inductive load | < 1 H |
| Capacitive load | 100 nF |
| Enclosure rating | IP67: EN 60529 |
| Temperature drift | < 0.1 mm/K |
| Lower signal level | 3.8 mA ... 4 mA |
| Upper signal level | 20 mA ... 20.5 mA |
| EMC | EN 61326-2-3, 2014/30/EU |

¹⁾ All connections are polarity protected. All outputs are overload and short-circuit protected.

Mechanics

| | |
|---------------------------|---------------------|
| Wetted parts | 1.4404, PTFE FKM |
| Process connection | G ¾ A |
| Housing material | Plastic PBT |
| Max. probe load | ≤ 6 Nm |

Ambient data

| | |
|--------------------------------------|-------------------|
| Ambient operating temperature | -20 °C ... +60 °C |
| Ambient temperature, storage | -40 °C ... +80 °C |

Classifications

| | |
|---------------------|----------|
| ECLASS 5.0 | 27200513 |
| ECLASS 5.1.4 | 27200513 |
| ECLASS 6.0 | 27200513 |
| ECLASS 6.2 | 27200513 |
| ECLASS 7.0 | 27200513 |
| ECLASS 8.0 | 27200513 |
| ECLASS 8.1 | 27200513 |

| | |
|-----------------------|----------|
| ECLASS 9.0 | 27200513 |
| ECLASS 10.0 | 27200513 |
| ECLASS 11.0 | 27200513 |
| ECLASS 12.0 | 27200513 |
| ETIM 5.0 | EC001447 |
| ETIM 6.0 | EC001447 |
| ETIM 7.0 | EC001447 |
| ETIM 8.0 | EC001447 |
| UNSPSC 16.0901 | 41113710 |

Type code

Type code

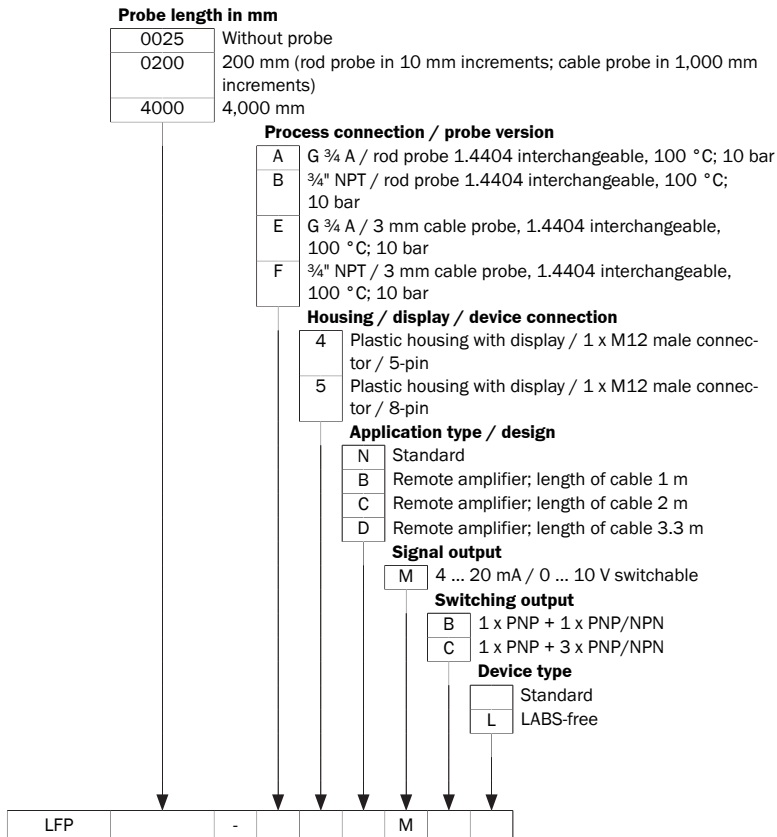

Not all variants of the type code can be combined!

Dependence between length of coaxial cable and probe length

| Length of coaxial cable (mm) | Max. probe length (mm) foam mode deactivated | Max. probe length (mm) foam mode active |
|------------------------------|--|---|
| 1000 | 4,000 | 2000 |
| 2000 | 3,000 | 1500 |
| 3300 | 1,000 | 500 |

Dimensional drawing (Dimensions in mm (inch))

Dimensional drawing: rod probe



- ① M: measuring range
- ② L: Probe length
- ③ IA: Inactive area at process connection 25 mm (0.98")
- ④ IAE: Inactive area at probe end 10 mm (0.39")

Connection type



- ① L⁺: Supply voltage, brown
- ② Q_A: Analog current-/voltage output, white
- ③ M: Ground, reference ground for current-/voltage output, blue
- ④ C/Q₁: Switching output 1, PNP/IO-Link-communication, black
- ⑤ Q₂: Switching output 2, PNP/NPN, grey

Instruction for installation



Mono rod probe mounted in metal tank

M = Measuring range
 X = Inactive area at probe end
No measurement possible

Rope probe mounted in metal tank

Installation in nozzle:
 $D \geq \text{DN } 25 \text{ (1")}$
Distance tank wall/tank bottom:
 $A \geq 50 \text{ mm (1.97")}$
Distance to other tank fittings:
 $\geq 100 \text{ mm (3.94")}$



Installation in a metal immersion tube or metal bypass

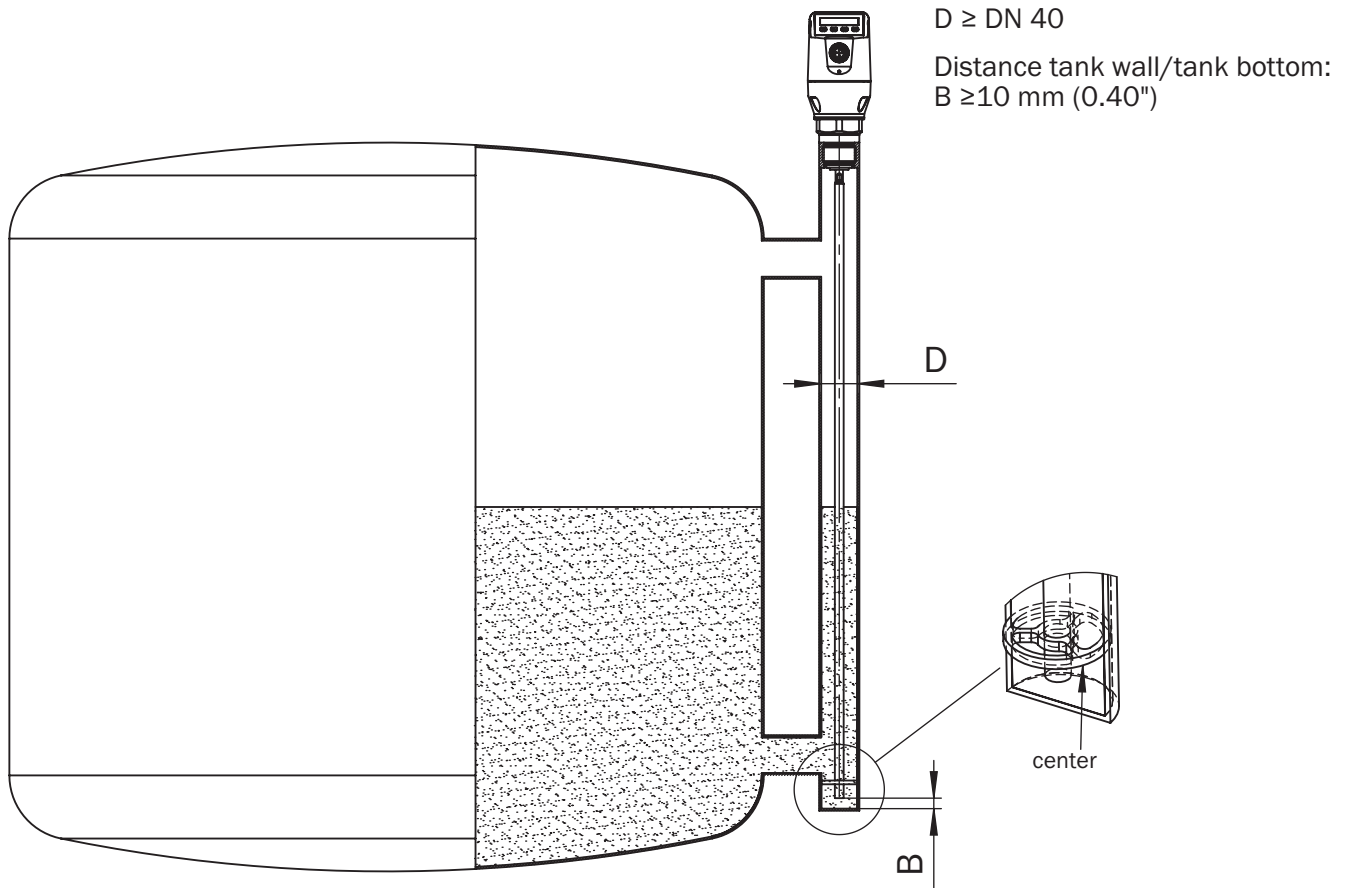

Installation in a metal tank



Unit with mono probe mounted in metal tank



Installation in nozzle:
 D \geq DN 25 (1")
 Distance tank wall/tank bottom:
 A \geq 50 mm (1.97")
 B \geq 10 mm (0.40")
 Distance to other tank fittings
 \geq 100mm (3.94")

Unit with coaxial tube for metal and non metal tank









C = with a coaxial tube there are no minimum distances to the tank wall or to other tank fittings required



Recommended accessories

Other models and accessories → www.sick.com/LFP_Cubic

| | Brief description | Type | Part no. |
|---|--|--------------------|----------|
| Spare parts | | | |
|  | Spare probe for LFP Cubic, probe length 1000 mm, material 1.4404/316L, diameter 7 mm | BEF-ER-SN1000-LFPC | 2065700 |
| | Spare probe for LFP Cubic, probe length 2000 mm, material 1.4404/316L, diameter 7 mm | BEF-ER-SN2000-LFPC | 2065701 |
| Device protection (mechanical) | | | |
|  | Coaxial tube for LFP with process connection G 3/4, process connection of coaxial tube G 3/4, material 1.4571/316TI, for probe length 200 mm | LFPCT-0200G1 | 2068141 |
| | Coaxial tube for LFP with process connection G 3/4, process connection of coaxial tube G 3/4, material 1.4571/316TI, for probe length 300 mm | LFPCT-0300G1 | 2068142 |

| | Brief description | Type | Part no. |
|---|---|--------------------|----------|
| | Coaxial tube for LFP with process connection G 3/4, process connection of coaxial tube G 3/4, material 1.4571/316TI, for probe length 400 mm | LFPCT-0400G1 | 2068143 |
| | Coaxial tube for LFP with process connection G 3/4, process connection of coaxial tube G 3/4, material 1.4571/316TI, for probe length 500 mm | LFPCT-0500G1 | 2068144 |
| | Coaxial tube for LFP with process connection G 3/4, process connection of coaxial tube G 3/4, material 1.4571/316TI, for probe length 600 mm | LFPCT-0600G1 | 2068145 |
| | Coaxial tube for LFP with process connection G 3/4, process connection of coaxial tube G 3/4, material 1.4571/316TI, for probe length 700 mm | LFPCT-0700G1 | 2068146 |
| | Coaxial tube for LFP with process connection G 3/4, process connection of coax probe G 3/4, material 1.4571/316TI, for probe length 800 mm | LFPCT-0800G1 | 2068147 |
| | Coaxial probe for LFP with process connection G 3/4, process connection of coaxial tube G 3/4, material 1.4571/316TI, for probe length 900 mm | LFPCT-0900G1 | 2067507 |
| | Coaxial tube for LFP with process connection G 3/4, process connection of coaxial tube G 3/4, material 1.4571/316TI, for probe length 1000 mm | LFPCT-1000G1 | 2065702 |
| | Coaxial tube for LFP with process connection G 3/4, process connection of coaxial tube G 3/4, material 1.4571/316TI, for probe length 1100 mm | LFPCT-1100G1 | 2068148 |
| | Coaxial tube for LFP with process connection G 3/4, process connection of coaxial tube G 3/4, material 1.4571/316TI, for probe length 1200 mm | LFPCT-1200G1 | 2068149 |
| | Coaxial tube for LFP with process connection G 3/4, process connection of coaxial tube G 3/4, material 1.4571/316TI, for probe length 1300 mm | LFPCT-1300G1 | 2068150 |
| | Coaxial tube for LFP with process connection G 3/4, process connection of coaxial tube G 3/4, material 1.4571/316TI, for probe length 1400 mm | LFPCT-1400G1 | 2068151 |
| | Coaxial tube for LFP with process connection G 3/4, process connection of coaxial tube G 3/4, material 1.4571/316TI, for probe length 1500 mm | LFPCT-1500G1 | 2068152 |
| | Coaxial tube for LFP with process connection G 3/4, process connection of coaxial tube G 3/4, material 1.4571/316TI, for probe length 1600 mm | LFPCT-1600G1 | 2068153 |
| | Coaxial tube for LFP with process connection G 3/4, process connection of coaxial tube G 3/4, material 1.4571/316TI, for probe length 1700 mm | LFPCT-1700G1 | 2068154 |
| | Coaxial tube for LFP with process connection G 3/4, process connection of coaxial tube G 3/4, material 1.4571/316TI, for probe length 1800 mm | LFPCT-1800G1 | 2068155 |
| | Coaxial tube for LFP with process connection G 3/4, process connection of coax probe G 3/4, material 1.4571/316TI, for probe length 1900 mm | LFPCT-1900G1 | 2068156 |
| | Coaxial tube for LFP with process connection G 3/4, process connection of coaxial tube G 3/4, material 1.4571/316TI, for probe length 2000 mm | LFPCT-2000G1 | 2065703 |
| Flanges | | | |
|  | Process connection adapter G 3/4 to G1 | BEF-HA-G1BSP1-LFP1 | 2067603 |
|  | Weld-in flange G 3/4" | BEF-FL-GEWG34-LFP1 | 2082150 |
| Mounting brackets and plates | | | |
|  | Mounting bracket, stainless steel 1.4301 (AISI 304), mounting hardware included | BEF-FL-304LFP-HLDR | 2077391 |

| | Brief description | Type | Part no. |
|---|---|--------------------|----------|
| Plug connectors and cables | | | |
|  | <ul style="list-style-type: none"> • Connection type head A: Female connector, M12, 5-pin, straight, A-coded • Connection type head B: Flying leads • Signal type: Sensor/actuator cable • Cable: 2 m, 5-wire, PUR, halogen-free • Description: Sensor/actuator cable, unshielded • Application: Zones with oils and lubricants, Drag chain operation, Robot | YF2A15-020UB5XLEAX | 2095617 |
|  | <ul style="list-style-type: none"> • Connection type head A: Female connector, M12, 5-pin, straight, A-coded • Connection type head B: Flying leads • Signal type: Sensor/actuator cable • Cable: 2 m, 5-wire, PVC • Description: Sensor/actuator cable, unshielded • Application: Zones with chemicals | YF2A15-020VB5XLEAX | 2096239 |
|  | <ul style="list-style-type: none"> • Connection type head A: Female connector, M12, 5-pin, straight, A-coded • Connection type head B: Flying leads • Signal type: Sensor/actuator cable • Cable: 5 m, 5-wire, PUR, halogen-free • Description: Sensor/actuator cable, unshielded • Application: Zones with oils and lubricants, Drag chain operation, Robot | YF2A15-050UB5XLEAX | 2095618 |
|  | <ul style="list-style-type: none"> • Connection type head A: Female connector, M12, 5-pin, straight, A-coded • Connection type head B: Flying leads • Signal type: Sensor/actuator cable • Cable: 5 m, 5-wire, PVC • Description: Sensor/actuator cable, unshielded • Application: Zones with chemicals | YF2A15-050VB5XLEAX | 2096240 |
|  | <ul style="list-style-type: none"> • Connection type head A: Female connector, M12, 5-pin, straight, A-coded • Connection type head B: Flying leads • Signal type: Sensor/actuator cable • Cable: 10 m, 5-wire, PUR, halogen-free • Description: Sensor/actuator cable, unshielded • Application: Zones with oils and lubricants, Drag chain operation, Robot | YF2A15-100UB5XLEAX | 2095619 |
|  | <ul style="list-style-type: none"> • Connection type head A: Female connector, M12, 5-pin, straight, A-coded • Connection type head B: Flying leads • Signal type: Sensor/actuator cable • Cable: 10 m, 5-wire, PVC • Description: Sensor/actuator cable, unshielded • Application: Zones with chemicals | YF2A15-100VB5XLEAX | 2096241 |
|  | <ul style="list-style-type: none"> • Connection type head A: Female connector, M12, 5-pin, angled, A-coded • Connection type head B: Flying leads • Signal type: Sensor/actuator cable • Cable: 2 m, 5-wire, PUR, halogen-free • Description: Sensor/actuator cable, unshielded • Application: Zones with oils and lubricants, Drag chain operation, Robot | YG2A15-020UB5XLEAX | 2095772 |
|  | <ul style="list-style-type: none"> • Connection type head A: Female connector, M12, 5-pin, angled, A-coded • Connection type head B: Flying leads • Signal type: Sensor/actuator cable • Cable: 2 m, 5-wire, PVC • Description: Sensor/actuator cable, unshielded • Application: Zones with chemicals | YG2A15-020VB5XLEAX | 2096215 |
|  | <ul style="list-style-type: none"> • Connection type head A: Female connector, M12, 5-pin, angled, A-coded • Connection type head B: Flying leads • Signal type: Sensor/actuator cable • Cable: 5 m, 5-wire, PUR, halogen-free • Description: Sensor/actuator cable, unshielded • Application: Zones with oils and lubricants, Drag chain operation, Robot | YG2A15-050UB5XLEAX | 2095773 |
|  | <ul style="list-style-type: none"> • Connection type head A: Female connector, M12, 5-pin, angled, A-coded • Connection type head B: Flying leads • Signal type: Sensor/actuator cable • Cable: 5 m, 5-wire, PVC • Description: Sensor/actuator cable, unshielded • Application: Zones with chemicals | YG2A15-050VB5XLEAX | 2096216 |

| | Brief description | Type | Part no. |
|---|---|--------------------|----------|
|  | <ul style="list-style-type: none"> • Connection type head A: Female connector, M12, 5-pin, angled, A-coded • Connection type head B: Flying leads • Signal type: Sensor/actuator cable • Cable: 10 m, 5-wire, PUR, halogen-free • Description: Sensor/actuator cable, unshielded • Application: Zones with oils and lubricants, Drag chain operation, Robot | YG2A15-100UB5XLEAX | 2095774 |
|  | <ul style="list-style-type: none"> • Connection type head A: Female connector, M12, 5-pin, angled, A-coded • Connection type head B: Flying leads • Signal type: Sensor/actuator cable • Cable: 10 m, 5-wire, PVC • Description: Sensor/actuator cable, unshielded • Application: Zones with chemicals | YG2A15-100VB5XLEAX | 2096217 |

Recommended services

Additional services → www.sick.com/LFP_Cubic

| | Type | Part no. |
|--|------------------------|------------|
| Function Block Factory | | |
| <ul style="list-style-type: none"> • Description: The Function Block Factory supports common programmable logic controllers (PLCs) from various manufacturers, such as Siemens, Beckhoff, Rockwell Automation and B&R. More information on the FBF can be found <a _blank"="" href="https://fbf.cloud.sick.com target=">here. • Note: You can configure your function block at <a _blank"="" href="https://fbf.cloud.sick.com target=">Function Block Factory. As a login please use your SICK ID. | Function Block Factory | On request |

SICK AT A GLANCE

SICK is one of the leading manufacturers of intelligent sensors and sensor solutions for industrial applications. A unique range of products and services creates the perfect basis for controlling processes securely and efficiently, protecting individuals from accidents and preventing damage to the environment.

We have extensive experience in a wide range of industries and understand their processes and requirements. With intelligent sensors, we can deliver exactly what our customers need. In application centers in Europe, Asia and North America, system solutions are tested and optimized in accordance with customer specifications. All this makes us a reliable supplier and development partner.

Comprehensive services complete our offering: SICK LifeTime Services provide support throughout the machine life cycle and ensure safety and productivity.

For us, that is “Sensor Intelligence.”

WORLDWIDE PRESENCE:

Contacts and other locations –www.sick.com