

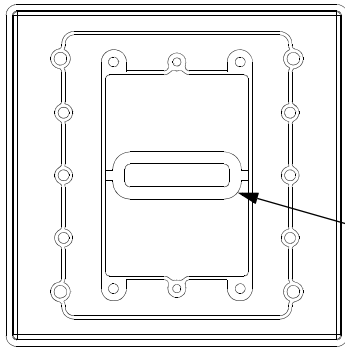

The MIWBA** in-wall box adapter is used to adapt Pan-Net single gang faceplates or four module space surface mount boxes to most double gang electrical boxes, as well as double gang wall board adapters. Faceplate can be mounted horizontal or vertical.

Mounting Screw Breakouts



Back View

Rectangular Washer

Mounting screw breakouts may be required to mount adapter.

To Use Breakouts:

1. Remove rectangular washer by twisting off.
2. Place MIWBA** on hard, flat surface.
3. Slide rectangular washer underneath desired breakout.
4. Push down firmly with pointed object. (Corner of screwdriver, hole punch, etc.)

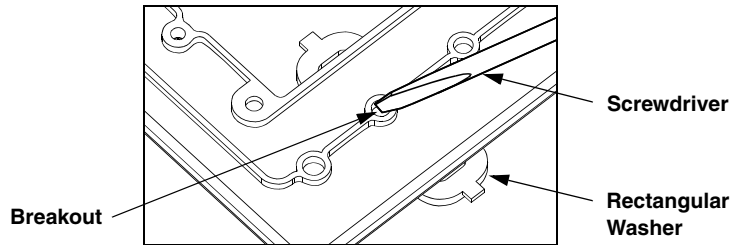

Breakout

Screwdriver

Rectangular Washer

1. Determine the apparatus that MIWBA** Adapter is to be mounted to.
2. Determine desired mounting orientation from the following options:

A.

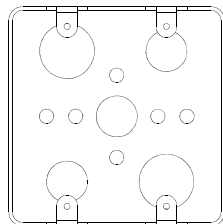

Electrical Box Type:
Double Gang, 4" square box

MIWBA** Mounted Vertically

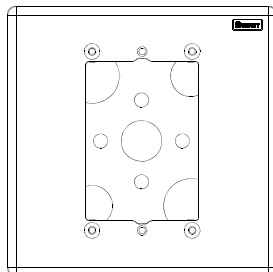

MIWBA** Mounted Horizontally

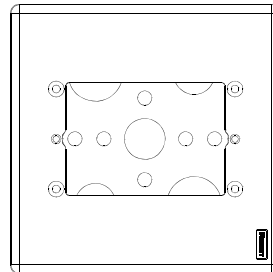

Screws required: 4
Size: #6-32 x 1"

OR

Screws required: 2
Size: #8-32 x 1"

Depending on the electrical box

B.

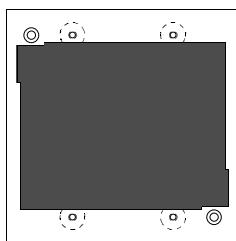

Double Gang Wall Board Adapter (Panduit Part Number: MWBA-2G)

MIWBA** Mounted Vertically

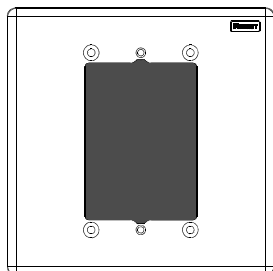

MIWBA** Mounted Horizontally

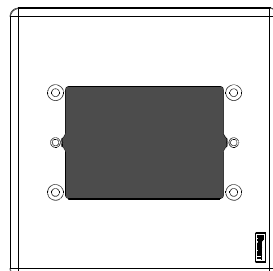

Screws required: 4
Size: #6-32 x 1"

Notes:

1. When mounting a single gang faceplate to MIWBA**, use screw size #6-20 x 1/2".
2. When mounting a surface mount box to MIWBA**, use screw size #6-20 x 1/4".

As with all Wiring Accessories, the following statements apply:

1. Never Install communications wiring during a lightning storm.
2. Never install communication wiring in wet locations unless the module is specifically designed for use in wet locations.
3. Never touch uninsulated communications wiring or terminals unless the communication line has been disconnected at the network interface.
4. Use caution when installing or modifying communication wiring.

** Denotes Color.

For Instructions in Local Languages
and Technical Support:

www.panduit.com/resources/install_maintain.asp

PANDUIT

www.panduit.com

E-mail:
cs@panduit.com

Fax:
(708) 444-6993