



## Product Compliance

[For compliance documentation, visit the product page on TE.com>](#)

EU RoHS Directive 2011/65/EU	Compliant with Exemptions
EU ELV Directive 2000/53/EC	Compliant
China RoHS 2 Directive MIIT Order No 32, 2016	Restricted Materials Above Threshold
EU REACH Regulation (EC) No. 1907/2006	Current ECHA Candidate List: JUNE 2022 (224) Candidate List Declared Against: JUL 2021 (219) Does not contain REACH SVHC
Halogen Content	Low Halogen - Br, Cl, F, I < 900 ppm per homogenous material. Also BFR/CFR/PVC Free
Solder Process Capability	Not reviewed for solder process capability

### Product Compliance Disclaimer

This information is provided based on reasonable inquiry of our suppliers and represents our current actual knowledge based on the information they provided. This information is subject to change. The part numbers that TE has identified as EU RoHS compliant have a maximum concentration of 0.1% by weight in homogenous materials for lead, hexavalent chromium, mercury, PBB, PBDE, DBP, BBP, DEHP, DIBP, and 0.01% for cadmium, or qualify for an exemption to these limits as defined in the Annexes of Directive 2011/65/EU (RoHS2). Finished electrical and electronic equipment products will be CE marked as required by Directive 2011/65/EU. Components may not be CE marked. Additionally, the part numbers that TE has identified as EU ELV compliant have a maximum concentration of 0.1% by weight in homogenous materials for lead, hexavalent chromium, and mercury, and 0.01% for cadmium, or qualify for an exemption to these limits as defined in the Annexes of Directive 2000/53/EC (ELV). Regarding the REACH Regulation, the information TE provides on SVHC in articles for this part number is based on the latest European Chemicals Agency (ECHA) 'Guidance on requirements for substances in articles' posted at this URL: <https://echa.europa.eu/guidance-documents/guidance-on-reach>

## Compatible Parts

 <p>TE Part # 1SNA115277R2000 M6/8.STP</p>	 <p>TE Part # 1SNA115500R2500 M6/8.STP3</p>	 <p>TE Part # 1SNA115529R1500 M6/8.STP1</p>	 <p>TE Part # 1SNA115678R0200 M6/8.STP.RS</p>
---	--	--	--



TE Part # 1SNA400015R2000  
ES8-CG

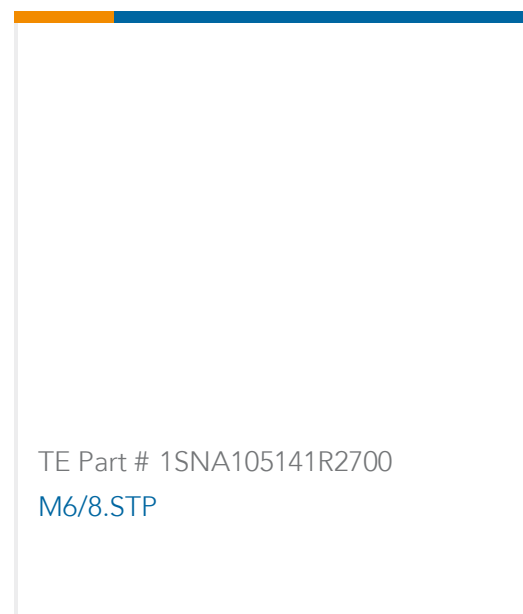

TE Part # 1SNA105141R2700  
M6/8.STP

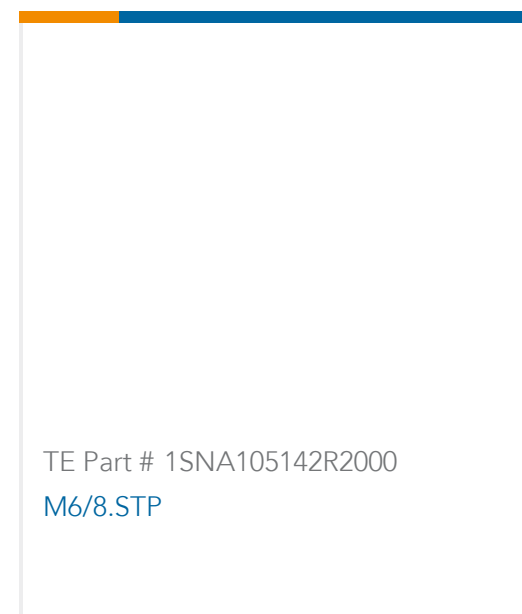

TE Part # 1SNA105142R2000  
M6/8.STP

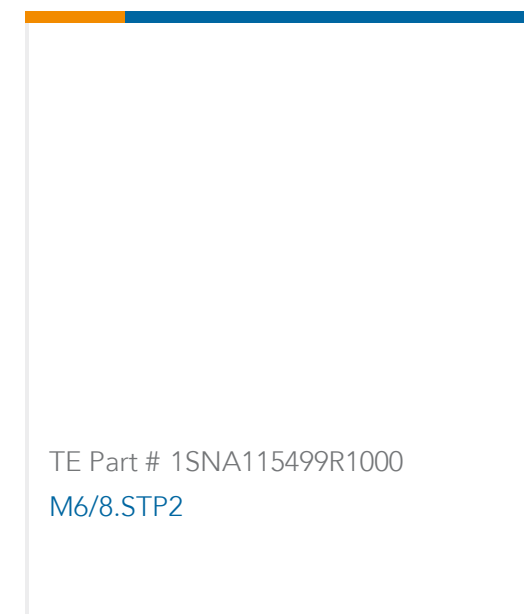

TE Part # 1SNA115499R1000  
M6/8.STP2

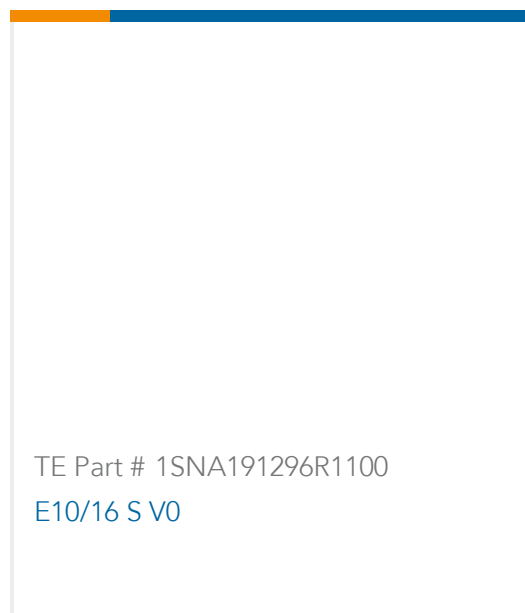

TE Part # 1SNA191296R1100  
E10/16 S V0

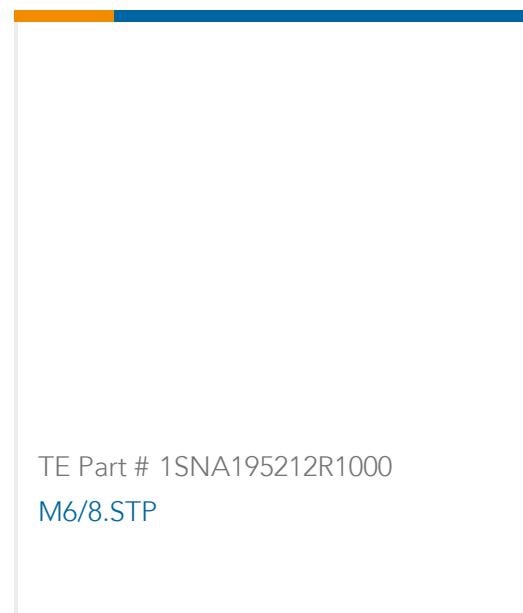

TE Part # 1SNA195212R1000  
M6/8.STP

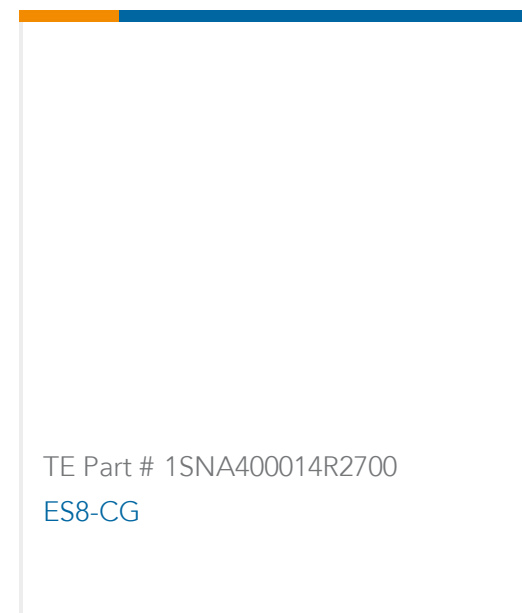

TE Part # 1SNA400014R2700  
ES8-CG

## Customers Also Bought



TE Part #W2S  
DEUTSCH DT Wedgelocks



TE Part #0460-202-16141  
DEUTSCH SOLID CONTACTS



TE Part #282104-1  
AMP SUPERSEAL 1.5MM,  
CONNECTOR HOUSING



TE Part #206070-8  
CABLE CLAMP KIT #17

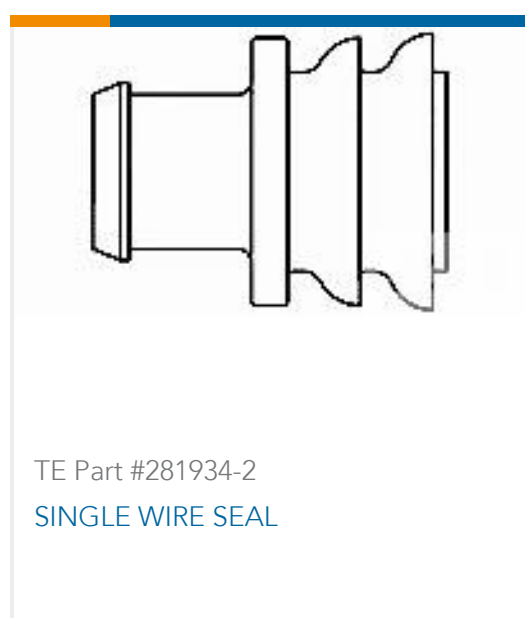

TE Part #281934-2  
SINGLE WIRE SEAL

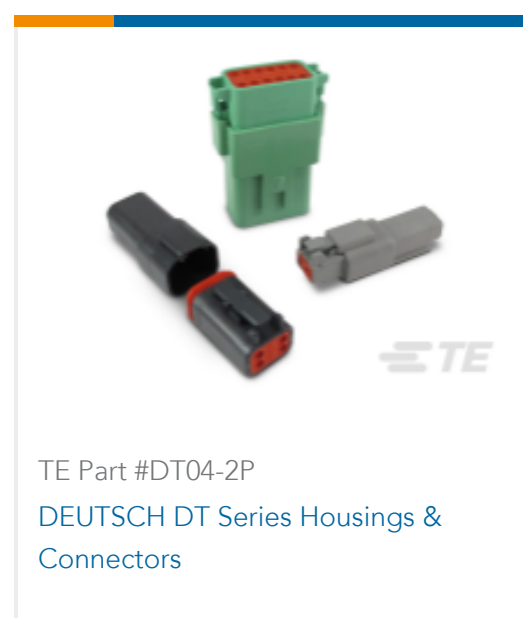

TE Part #DT04-2P  
DEUTSCH DT Series Housings &  
Connectors

## Documents

### Datasheets & Catalog Pages

[Catalogue - ENTRELEC terminal-blocks-sna-series](#)

English

[BNSTP1-BE](#)

English

[ENTRELEC Terminal Block - Master Catalog](#)

English

[ENTRELEC Terminal Blocks Catalogue \(RUS\)](#)

