



Product designation				Power contactor
Product type designation				BF18
Contact characteristics				
Number of poles	Nr.			4
Rated insulation voltage U_i IEC/EN	V			690
Rated impulse withstand voltage U_{imp}	kV			6
Operational frequency	min	Hz	25	
	max	Hz	400	
IEC Conventional free air thermal current I_{th}	A			32
Operational current I_e	AC-1 ($\leq 40^\circ\text{C}$)	A	32	
	AC-1 ($\leq 55^\circ\text{C}$)	A	26	
	AC-1 ($\leq 70^\circ\text{C}$)	A	23	
	AC-3 ($\leq 440\text{V} \leq 55^\circ\text{C}$)	A	18	
	AC-4 (400V)	A	8.5	
Rated operational power AC-1 ($T \leq 40^\circ\text{C}$)	230V	kW	12	
	400V	kW	21	
	500V	kW	26	
	690V	kW	36	
IEC max current I_e in DC1 with $L/R \leq 1\text{ms}$ with 1 poles in series	$\leq 24\text{V}$	A	17	
	48V	A	15	
	75V	A	15	
	110V	A	6	
	220V	A	-	
IEC max current I_e in DC1 with $L/R \leq 1\text{ms}$ with 2 poles in series	$\leq 24\text{V}$	A	20	
	48V	A	20	
	75V	A	20	
	110V	A	13	
	220V	A	1	
IEC max current I_e in DC1 with $L/R \leq 1\text{ms}$ with 3 poles in series	$\leq 24\text{V}$	A	22	
	48V	A	22	
	75V	A	20	
	110V	A	16	
	220V	A	11	
IEC max current I_e in DC1 with $L/R \leq 1\text{ms}$ with 4 poles in series	$\leq 24\text{V}$	A	22	
	48V	A	22	
	75V	A	20	
	110V	A	18	
	220V	A	13	

IEC max current I _e in DC3-DC5 with L/R ≤ 15ms with 1 poles in series	≤24V	A	12
	48V	A	11
	75V	A	11
	110V	A	2
	220V	A	–
	IEC max current I _e in DC3-DC5 with L/R ≤ 15ms with 2 poles in series	≤24V	A
48V		A	13
75V		A	13
110V		A	8
220V		A	2
IEC max current I _e in DC3-DC5 with L/R ≤ 15ms with 3 poles in series		≤24V	A
	48V	A	18
	75V	A	16
	110V	A	12
	220V	A	6
	IEC max current I _e in DC3-DC5 with L/R ≤ 15ms with 4 poles in series	≤24V	A
48V		A	18
75V		A	16
110V		A	13
220V		A	8
Short-time allowable current for 10s (IEC/EN60947-1)			A
Protection fuse	gG (IEC)	A	32
	aM (IEC)	A	20
Making capacity (RMS value)		A	180
Breaking capacity at voltage	440V	A	144
	500V	A	120
	690V	A	94
			mΩ
Resistance per pole (average value)			
Power dissipation per pole (average value)	I _{th}	W	2.6
	AC-3	W	0.8
Tightening torque for terminals	min	Nm	1.5
	max	Nm	1.8
	min	I _{bin}	1.1
	max	I _{bin}	1.5
Tightening torque for coil terminal	min	Nm	0.8
	max	Nm	1
	min	I _{bin}	0.8
	max	I _{bin}	0.74
Max number of wires simultaneously connectable		Nr.	2
Conductor section	AWG/Kcmil		
	max		10
Flexible w/o lug conductor section	min	mm ²	1

	max	mm ²	6
Flexible c/w lug conductor section	min	mm ²	1
	max	mm ²	4
Flexible with insulated spade lug conductor section	min	mm ²	1
	max	mm ²	4
Power terminal protection according to IEC/EN 60529			IP20 when properly wired
Mechanical features			
Operating position	normal allowable		Vertical plan ±30°
Fixing			Screw / DIN rail 35mm
Weight		g	358
Conductor section			
AWG/kcmil conductor section	max		10
Operations			
Mechanical life		cycles	20000000
Electrical life		cycles	1600000
Safety related data			
Performance level B10d according to EN/ISO 13489-1	rated load mechanical load	cycles	1600000
		cycles	20000000
Mirror contacts according to IEC/EN 60947-4-1			yes
EMC compatibility			yes
AC coil operating			
Rated AC voltage at 50/60Hz		V	110
AC operating voltage			
of 50/60Hz coil powered at 50Hz			
pick-up	min	%Us	80
	max	%Us	110
drop-out	min	%Us	20
	max	%Us	55
of 50/60Hz coil powered at 60Hz			
pick-up	min	%Us	85
	max	%Us	110
drop-out	min	%Us	20
	max	%Us	55
AC average coil consumption at 20°C			
of 50/60Hz coil powered at 50Hz			
	in-rush	VA	75
	holding	VA	9
of 50/60Hz coil powered at 60Hz			
	in-rush	VA	70
	holding	VA	6.5
of 60Hz coil powered at 60Hz			
	in-rush	VA	75

	holding	VA	9
Dissipation at holding $\leq 20^{\circ}\text{C}$ 50Hz		W	2.5
Max cycles frequency			
Mechanical operation		cycles/h	3600
Operating times			
Average time for U_s control in AC			
	Closing NO		
		min	ms 8
		max	ms 24
	Opening NO		
		min	ms 10
		max	ms 20
	Closing NC		
		min	ms 14
		max	ms 28
	Opening NC		
		min	ms 7
		max	ms 18
UL technical data			
Full-load current (FLA) for three-phase AC motor			
	at 480V	A	14
	at 600V	A	17
Yielded mechanical performance			
for single-phase AC motor			
	110/120V	HP	1
	230V	HP	3
for three-phase AC motor			
	200/208V	HP	5
	220/230V	HP	5
	460/480V	HP	10
	575/600V	HP	15
General USE			
Contactor			
	AC current	A	32
Short-circuit protection fuse, 600V			
High fault			
	Short circuit current	kA	100
	Fuse rating	A	60
	Fuse class		J
Standard fault			
	Short circuit current	kA	5
	Fuse rating	A	80
Ambient conditions			
Temperature			
Operating temperature			
	min	$^{\circ}\text{C}$	-50
	max	$^{\circ}\text{C}$	70
Storage temperature			
	min	$^{\circ}\text{C}$	-60
	max	$^{\circ}\text{C}$	80
Max altitude		m	3000
Resistance & Protection			
Pollution degree			3

Dimensions

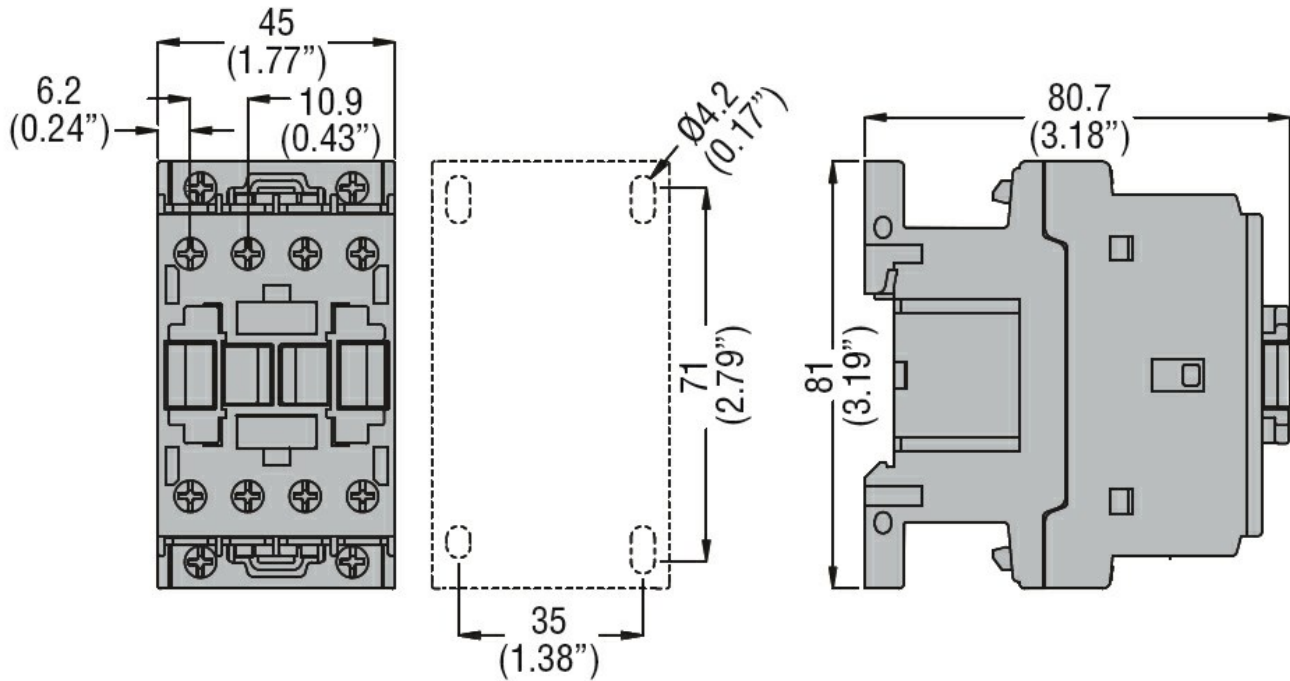

Wiring diagrams

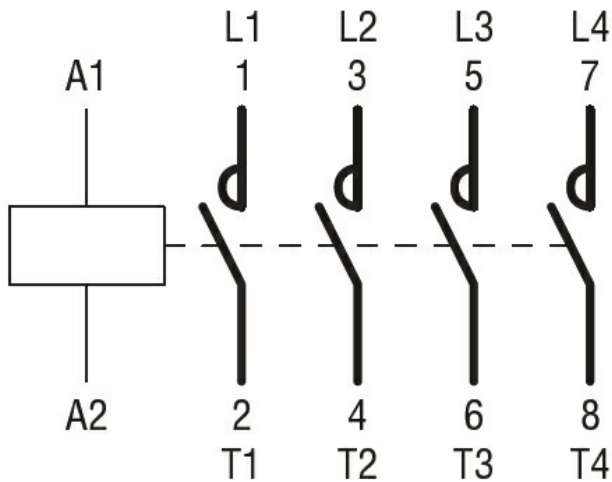

Certifications and compliance

Compliance

CSA C22.2 n° 60947-1
CSA C22.2 n° 60947-4-1
IEC/EN/BS 60947-1
IEC/EN/BS 60947-4-1
UL 60947-1
UL 60947-4-1

Certificates

CCC
cULus
EAC

ETIM classification

ETIM 8.0

EC000066 -
Power contactor,
AC switching