



SYS/SGD-W4150010002BX3

Safeguard Detector

SAFETY SYSTEMS FOR AUTOMATING MATERIAL FLOWS

SICK
Sensor Intelligence.



Ordering information

Type	Part no.
SYS/SGD-W4150010002BX3	1129656

Included in delivery: UE410-SD300 (1), WTB4FP-213111A0ZZZ (2)

Other models and accessories → www.sick.com/Safeguard_Detector



Detailed technical data

Features

Reference object	Object with 90% remission factor (complies with standard white according to DIN 5033)
Minimum distance between set sensing range and background (black 6% / white 90%)	30 mm, at a distance of 150 mm

Safety-related parameters of the safety system

Category	Category 3 (EN ISO 13849-1)
Performance level	PL d (EN ISO 13849-1)
Performance class SRS/SRSS	D (IEC TS 62998-1)
PFH_D (mean probability of a dangerous failure per hour)	$1.0 * 10^{-7}$
DC_{avg} (diagnostic coverage)	80 % (EN ISO 13849-1)
MTTF_D (mean time to dangerous failure)	250 years (EN ISO 13849-1)

UE410-SD safety evaluation module

Note	The UE410-SD safety evaluation module can be operated with one or two MultiPulse sensor pairs. The actuator can be connected directly to the UE410-SD safety evaluation module. The safety chain can also be expanded with additional logic elements (e.g., a higher-level safety controller).
Configuration method	Hard wired
Number of connectable sensor pairs	1 or 2
Connection type	Screw-type terminals
Pulse rate of the sensors	10 Hz
Supply voltage V_S	24 V DC (19.2 V ... 30 V)
Protection class	III (EN 50178)
Enclosure rating	IP20 (EN 60529)
Ambient operating temperature	-25 °C ... 55 °C
Response time of the overall safety system (sensors and safety evaluation module)	≤ 160 ms

Classifications

eCl@ss 5.0	27279090
eCl@ss 5.1.4	27279090

eCl@ss 6.0	27279090
eCl@ss 6.2	27279090
eCl@ss 7.0	27279090
eCl@ss 8.0	27279090
eCl@ss 8.1	27279090
eCl@ss 9.0	27279090
eCl@ss 10.0	27279090
eCl@ss 11.0	27279090
eCl@ss 12.0	27279090
ETIM 5.0	EC001449
ETIM 6.0	EC001449
ETIM 7.0	EC001449
ETIM 8.0	EC001449
UNSPSC 16.0901	32151705

Dimensional drawing (Dimensions in mm (inch))

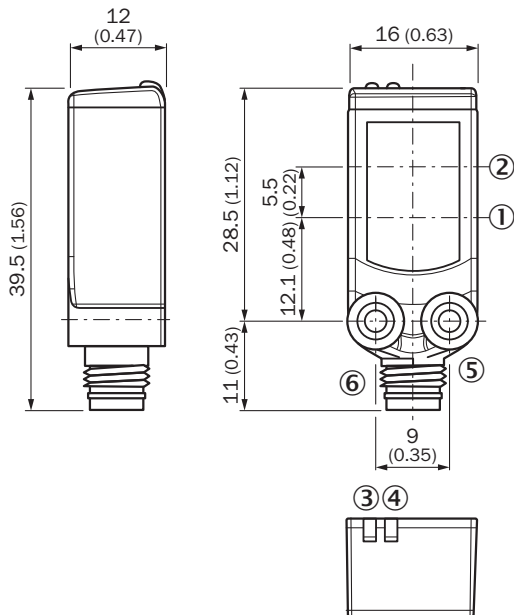

SICK AT A GLANCE

SICK is one of the leading manufacturers of intelligent sensors and sensor solutions for industrial applications. A unique range of products and services creates the perfect basis for controlling processes securely and efficiently, protecting individuals from accidents and preventing damage to the environment.

We have extensive experience in a wide range of industries and understand their processes and requirements. With intelligent sensors, we can deliver exactly what our customers need. In application centers in Europe, Asia and North America, system solutions are tested and optimized in accordance with customer specifications. All this makes us a reliable supplier and development partner.

Comprehensive services complete our offering: SICK LifeTime Services provide support throughout the machine life cycle and ensure safety and productivity.

For us, that is “Sensor Intelligence.”

WORLDWIDE PRESENCE:

Contacts and other locations –www.sick.com