



WL4SLG-3P5254H

W4

MINIATURE PHOTOELECTRIC SENSORS

**SICK**  
Sensor Intelligence.



Illustration may differ

## Ordering information

Type	Part no.
WL4SLG-3P5254H	1109333

Other models and accessories → [www.sick.com/W4](http://www.sick.com/W4)



## Detailed technical data

### Features

<b>Functional principle</b>	Photoelectric retro-reflective sensor
<b>Functional principle detail</b>	Autocollimation
<b>Sensing range max.</b>	0 m ... 3.5 m <sup>1)</sup>
<b>Sensing range</b>	0 m ... 2.2 m <sup>1)</sup>
<b>Polarisation filters</b>	Yes
<b>Emitted beam</b>	
Light source	Laser <sup>2)</sup>
Type of light	Visible red light
Light spot size (distance)	Ø 1 mm (500 mm)
<b>Key laser figures</b>	
Normative reference	EN 60825-1:2014, IEC 60825-1:2014 / CDRH 21 CFR 1040.10 & 1040.11
Laser class	1
Wave length	650 nm
<b>Adjustment</b>	Teach-in by wire <sup>3)</sup>

<sup>1)</sup> Reflective tape REF-AC1000.

<sup>2)</sup> Average service life: 50,000 h at T<sub>U</sub> = +25 °C.

<sup>3)</sup> External teach-in: pulse > 2 s with voltage U<sub>v</sub> with PNP and M with NPN.

<sup>4)</sup> Difference between standard/washdown and hygiene: The essential difference between a standard/washdown product and a hygiene product is that where the process and contact with the medium (activity in the vicinity of the food) are concerned, a hygiene product is designed in accordance with the latest standards and hygiene design guidelines, and materials are selected accordingly.

<b>Special applications</b>	Hygienic and washdown zones, Detecting transparent objects, Detecting small objects
<b>Housing design</b>	Hygiene <sup>4)</sup>
<b>Mounting hole</b>	M3

<sup>1)</sup> Reflective tape REF-AC1000.

<sup>2)</sup> Average service life: 50,000 h at  $T_U = +25\text{ °C}$ .

<sup>3)</sup> External teach-in: pulse > 2 s with voltage  $U_v$  with PNP and M with NPN.

<sup>4)</sup> Difference between standard/washdown and hygiene: The essential difference between a standard/washdown product and a hygiene product is that where the process and contact with the medium (activity in the vicinity of the food) are concerned, a hygiene product is designed in accordance with the latest standards and hygiene design guidelines, and materials are selected accordingly.

### Safety-related parameters

<b>MTTF<sub>D</sub></b>	589 years (EN ISO 13849-1) <sup>1)</sup>
<b>DC<sub>avg</sub></b>	0 %

<sup>1)</sup> Mode of calculation: Parts-Count-calculation.

### Electrical data

<b>Supply voltage <math>U_B</math></b>	10 V DC ... 30 V DC <sup>1)</sup>
<b>Ripple</b>	< 5 V <sub>pp</sub> <sup>2)</sup>
<b>Current consumption</b>	30 mA <sup>3)</sup>
<b>Protection class</b>	III
<b>Digital output</b>	
Type	PNP
Switching mode	Light switching
Output current $I_{max}$	≤ 100 mA
Response time	≤ 0.5 ms <sup>4)</sup>
Switching frequency	1,000 Hz <sup>5)</sup>
<b>Circuit protection</b>	A <sup>6)</sup> B <sup>7)</sup> C <sup>8)</sup>
<b>Special feature</b>	D12 adapter shaft

<sup>1)</sup> Limit values when operated in short-circuit protected network: max. 8 A.

<sup>2)</sup> May not exceed or fall below  $U_v$  tolerances.

<sup>3)</sup> Without load.

<sup>4)</sup> Signal transit time with resistive load.

<sup>5)</sup> With light/dark ratio 1:1.

<sup>6)</sup> A =  $V_S$  connections reverse-polarity protected.

<sup>7)</sup> B = inputs and output reverse-polarity protected.

<sup>8)</sup> C = interference suppression.

### Mechanical data

<b>Housing</b>	Rectangular
<b>Design detail</b>	Slim
<b>Dimensions (W x H x D)</b>	15.3 mm x 63.2 mm x 22.2 mm
<b>Connection</b>	Male connector M8, 4-pin <sup>1)</sup>
<b>Material</b>	

<sup>1)</sup> Max. tightening torque: 0.6 Nm.

	Housing	Stainless steel, Stainless steel V4A (1.4404, 316L)
	Front screen	Plastic, PMMA
<b>Weight</b>		140 g

<sup>1)</sup> Max. tightening torque: 0.6 Nm.

## Ambient data

<b>Enclosure rating</b>	IP66 IP67 IP68 IP69K <sup>1)</sup>
<b>Ambient operating temperature</b>	-10 °C ... +50 °C
<b>Ambient operating temperature extended</b>	-30 °C ... +55 °C <sup>2) 3)</sup>
<b>Ambient temperature, storage</b>	-30 °C ... +70 °C
<b>RoHS certificate</b>	✓

<sup>1)</sup> Only in case of correctly mounted IP69K connecting cable.

<sup>2)</sup> As of  $T_a = 50\text{ °C}$ , a max. supply voltage  $V_{max.} = 24\text{ V}$  and a max. load current  $I_{max.} = 50\text{ mA}$  is permitted.

<sup>3)</sup> Operation below  $T_u - 10\text{ °C}$  is possible if the sensor is already switched on at  $T_u > -10\text{ °C}$ , then cools down, and the supply voltage is subsequently not switched off. Switching on below  $T_u - 10\text{ °C}$  is not permissible.

## Classifications

<b>ECLASS 5.0</b>	27270902
<b>ECLASS 5.1.4</b>	27270902
<b>ECLASS 6.0</b>	27270902
<b>ECLASS 6.2</b>	27270902
<b>ECLASS 7.0</b>	27270902
<b>ECLASS 8.0</b>	27270902
<b>ECLASS 8.1</b>	27270902
<b>ECLASS 9.0</b>	27270902
<b>ECLASS 10.0</b>	27270902
<b>ECLASS 11.0</b>	27270902
<b>ECLASS 12.0</b>	27270902
<b>ETIM 5.0</b>	EC002717
<b>ETIM 6.0</b>	EC002717
<b>ETIM 7.0</b>	EC002717
<b>ETIM 8.0</b>	EC002717
<b>UNSPSC 16.0901</b>	39121528

## Connection diagram

Cd-092

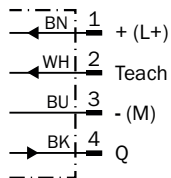

## Characteristic curve

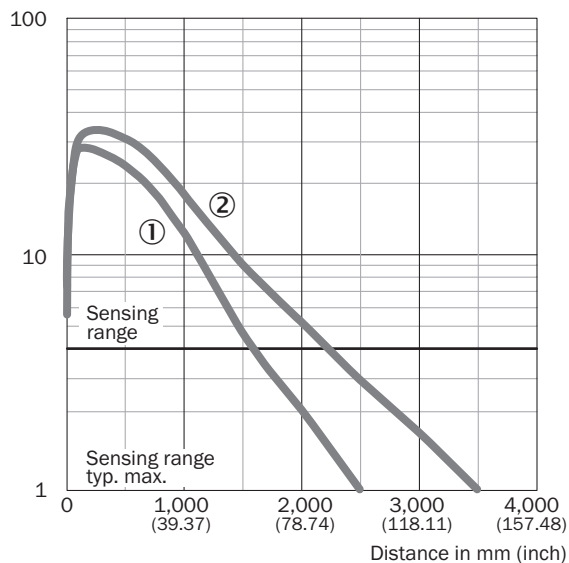

- ① Reflector PLV14-A / PLH25-M12 / PLH25-D12
- ② Reflector P41F / reflective tape REF-AC1000

## Light spot size

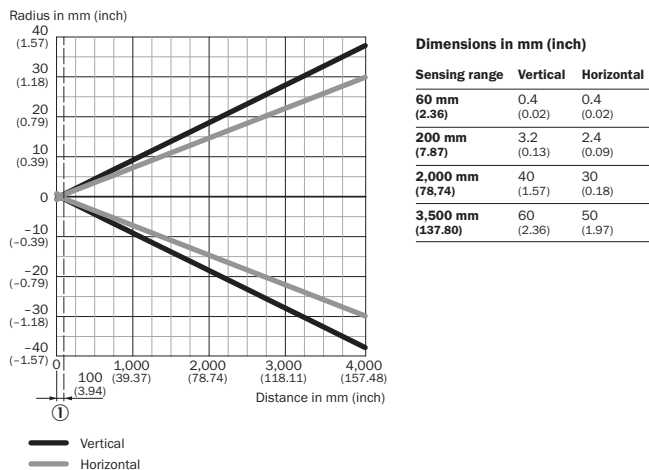

- ① Minimum distance between sensor and reflector

### Light spot size (detailed view)

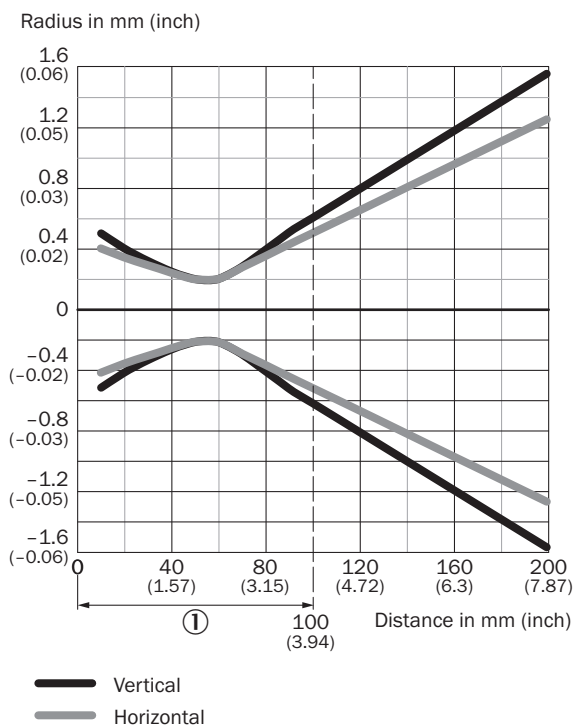

### Sensing range diagram

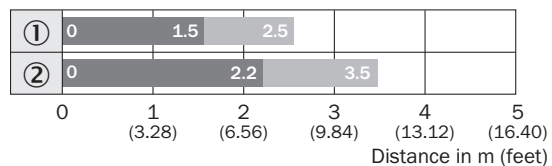

- ① Reflector PLV14-A / PLH25-M12 / PLH25-D12
- ② Reflector P41F / reflective tape REF-AC1000

Dimensional drawing (Dimensions in mm (inch))

WTB4S-3H, WTF4S-3H, with single teach-in button, D12 adapter shaft, L-adaption

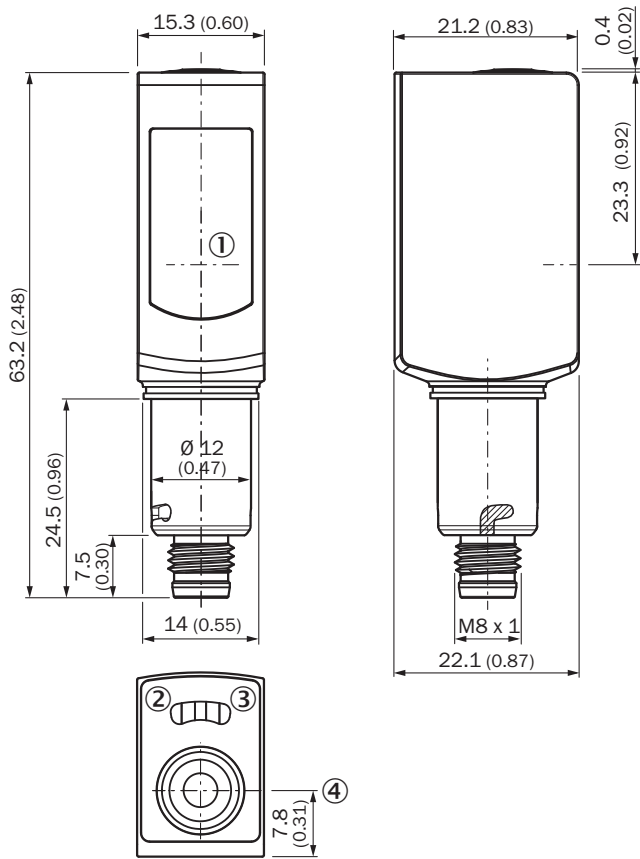

- ① Center of optical axis
- ② LED indicator yellow: Status of received light beam
- ③ LED indicator green: Supply voltage active
- ④ Single teach-in button

Recommended accessories

Other models and accessories → [www.sick.com/W4](http://www.sick.com/W4)

	Brief description	Type	Part no.
<b>Reflectors</b>			
	Stainless steel reflector, washdown design, chemically resistant, IP 69K enclosure rating, screw connection, PMMA front screens, 14 mm, Stainless steel V4A (1.4404, 316L), Screw-on, 2 hole mounting	PLV14-A	2063405

	Brief description	Type	Part no.
Others			
	<ul style="list-style-type: none"> <li>• <b>Connection type head A:</b> Female connector, M8, 4-pin, straight</li> <li>• <b>Connection type head B:</b> Flying leads</li> <li>• <b>Signal type:</b> Sensor/actuator cable</li> <li>• <b>Cable:</b> 5 m, 4-wire, PVC</li> <li>• <b>Description:</b> Sensor/actuator cable, unshielded</li> <li>• <b>Connection systems:</b> Flying leads</li> <li>• <b>Note:</b> This product is generally resistant to chemical cleaning agents (see ECOLAB). Please do not use cleaning agents of any other Kind., Not resistant against lactic acid &amp; hydrogen peroxide (H2O2)</li> <li>• <b>Application:</b> Hygienic and washdown zones</li> </ul>	DOL-0804-G05MNI	6059194



## SICK AT A GLANCE

SICK is one of the leading manufacturers of intelligent sensors and sensor solutions for industrial applications. A unique range of products and services creates the perfect basis for controlling processes securely and efficiently, protecting individuals from accidents and preventing damage to the environment.

We have extensive experience in a wide range of industries and understand their processes and requirements. With intelligent sensors, we can deliver exactly what our customers need. In application centers in Europe, Asia and North America, system solutions are tested and optimized in accordance with customer specifications. All this makes us a reliable supplier and development partner.

Comprehensive services complete our offering: SICK LifeTime Services provide support throughout the machine life cycle and ensure safety and productivity.

For us, that is “Sensor Intelligence.”

## WORLDWIDE PRESENCE:

Contacts and other locations –[www.sick.com](http://www.sick.com)