



Product designation
Product type designation

Power contactor
BF09

Contact characteristics

Number of poles	Nr.	4
Rated insulation voltage U _i IEC/EN	V	690
Rated impulse withstand voltage U _{imp}	kV	6
Operational frequency	min	Hz 25
	max	Hz 400
IEC Conventional free air thermal current I _{th}	A	25
Operational current I _e	AC-1 (≤40°C)	A 25
	AC-1 (≤55°C)	A 20
	AC-1 (≤70°C)	A 18
	AC-3 (≤440V ≤55°C)	A 9
	AC-4 (400V)	A 4.9
Rated operational power AC-1 (T≤40°C)	230V	kW 9.5
	400V	kW 16
	500V	kW 21
	690V	kW 27
IEC max current I _e in DC1 with L/R ≤ 1ms with 1 poles in series	≤24V	A 15
	48V	A 13
	75V	A 12
	110V	A 6
	220V	A –
IEC max current I _e in DC1 with L/R ≤ 1ms with 2 poles in series	≤24V	A 18
	48V	A 18
	75V	A 17
	110V	A 12
	220V	A 1
IEC max current I _e in DC1 with L/R ≤ 1ms with 3 poles in series	≤24V	A 20
	48V	A 20
	75V	A 20
	110V	A 15
	220V	A 10
IEC max current I _e in DC1 with L/R ≤ 1ms with 4 poles in series	≤24V	A 20
	48V	A 20
	75V	A 20
	110V	A 16
	220V	A 12

IEC max current I _e in DC3-DC5 with L/R ≤ 15ms with 1 poles in series	≤24V	A	10
	48V	A	9
	75V	A	8
	110V	A	2
	220V	A	–
	IEC max current I _e in DC3-DC5 with L/R ≤ 15ms with 2 poles in series	≤24V	A
48V		A	11
75V		A	10
110V		A	7
220V		A	2
IEC max current I _e in DC3-DC5 with L/R ≤ 15ms with 3 poles in series		≤24V	A
	48V	A	15
	75V	A	13
	110V	A	11
	220V	A	6
	IEC max current I _e in DC3-DC5 with L/R ≤ 15ms with 4 poles in series	≤24V	A
48V		A	15
75V		A	15
110V		A	12
220V		A	7
Short-time allowable current for 10s (IEC/EN60947-1)			A
Protection fuse	gG (IEC)	A	25
	aM (IEC)	A	10
Making capacity (RMS value)		A	90
Breaking capacity at voltage	440V	A	72
	500V	A	72
	690V	A	71
			mΩ
Resistance per pole (average value)			
Power dissipation per pole (average value)	I _{th}	W	1.6
	AC-3	W	0.2
Tightening torque for terminals	min	Nm	1.5
	max	Nm	1.8
	min	I _{bin}	1.1
	max	I _{bin}	1.5
Tightening torque for coil terminal	min	Nm	0.8
	max	Nm	1
	min	I _{bin}	0.8
	max	I _{bin}	0.74
Max number of wires simultaneously connectable		Nr.	2
Conductor section	AWG/Kcmil		
	max		10
Flexible w/o lug conductor section	min	mm ²	1

		max	mm ²	6
Flexible c/w lug conductor section		min	mm ²	1
		max	mm ²	4
Flexible with insulated spade lug conductor section		min	mm ²	1
		max	mm ²	4
Power terminal protection according to IEC/EN 60529				IP20 when properly wired
Mechanical features				
Operating position		normal allowable		Vertical plan ±30°
Fixing				Screw / DIN rail 35mm
Weight			g	356
Conductor section	AWG/kcmil conductor section			
		max		10
Operations				
Mechanical life			cycles	20000000
Electrical life			cycles	2000000
Safety related data				
Performance level B10d according to EN/ISO 13489-1		rated load mechanical load	cycles	2000000
			cycles	20000000
Mirror contacts according to IEC/EN 60947-4-1				yes
EMC compatibility				yes
AC coil operating				
Rated AC voltage at 60Hz			V	24
AC operating voltage	of 60Hz coil powered at 60Hz			
	pick-up	min	%Us	80
		max	%Us	110
	drop-out	min	%Us	20
		max	%Us	55
AC average coil consumption at 20°C	of 60Hz coil powered at 60Hz			
		in-rush holding	VA	75
			VA	9
Dissipation at holding ≤20°C 50Hz			W	2.5
Max cycles frequency				
Mechanical operation			cycles/h	3600
Operating times				
Average time for Us control	in AC			
	Closing NO	min	ms	8
		max	ms	24
	Opening NO	min	ms	10
		max	ms	20

Closing NC	min	ms	14
	max	ms	28
Opening NC	min	ms	7
	max	ms	18

UL technical data

Full-load current (FLA) for three-phase AC motor

at 480V	A	7.6
at 600V	A	0.375

Yielded mechanical performance

for single-phase AC motor

110/120V	HP	0.75
230V	HP	2

for three-phase AC motor

200/208V	HP	3
220/230V	HP	3
460/480V	HP	5
575/600V	HP	7.5

General USE

Contactor

AC current	A	25
------------	---	----

Short-circuit protection fuse, 600V

High fault

Short circuit current	kA	100
Fuse rating	A	30
Fuse class		J

Standard fault

Short circuit current	kA	5
Fuse rating	A	60

Ambient conditions

Temperature

Operating temperature

min	°C	-50
max	°C	70

Storage temperature

min	°C	-60
max	°C	80

Max altitude

m	3000
---	------

Resistance & Protection

Pollution degree

3

Dimensions

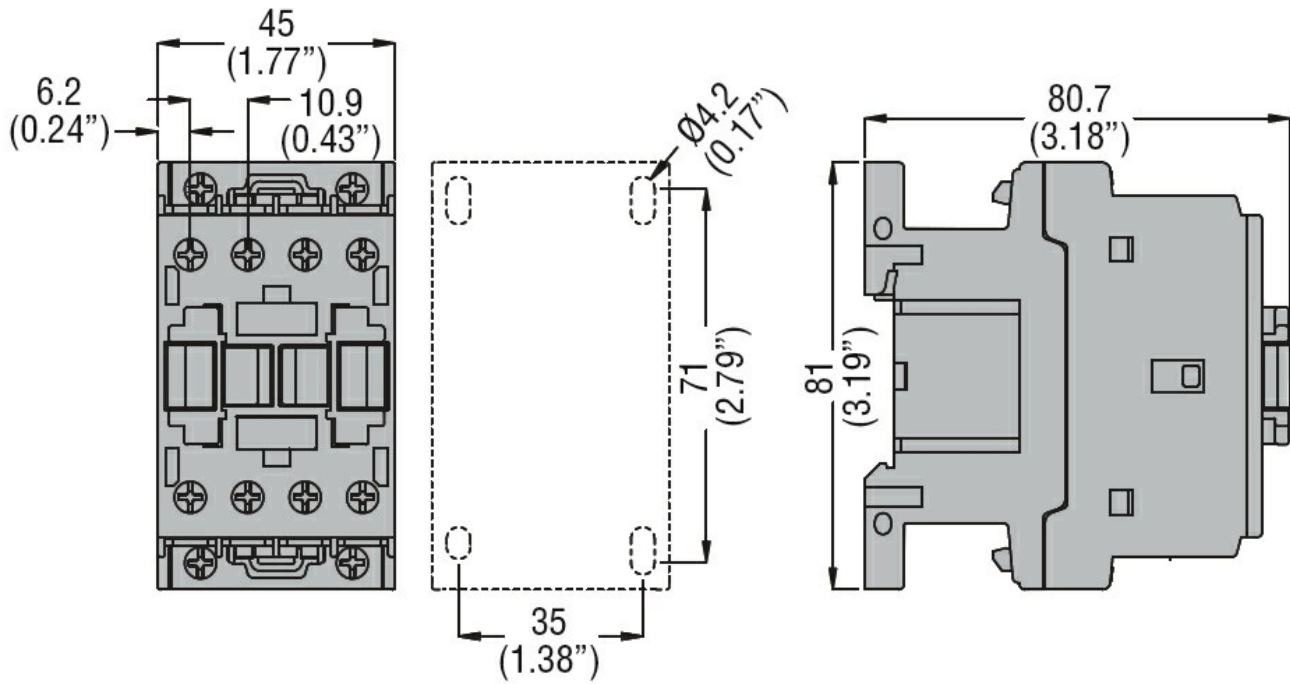

Wiring diagrams

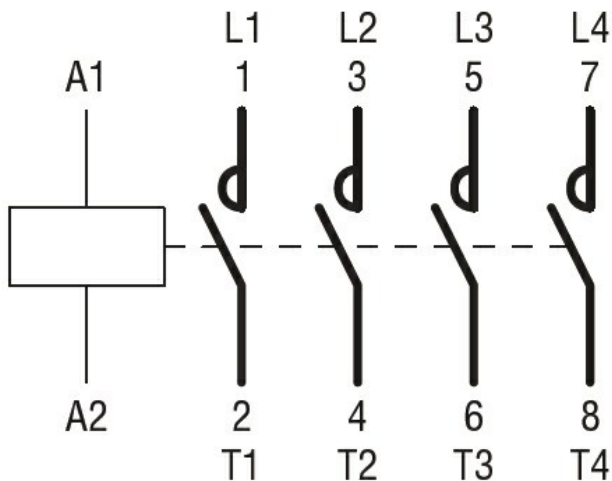

Certifications and compliance

Compliance

CSA C22.2 n° 60947-1
CSA C22.2 n° 60947-4-1
IEC/EN/BS 60947-1
IEC/EN/BS 60947-4-1
UL 60947-1
UL 60947-4-1

Certificates

CCC
cULus
EAC

ETIM classification

ETIM 8.0

EC000066 -
Power contactor,
AC switching