

XNE-GWBR-2ETH-MB Gateway

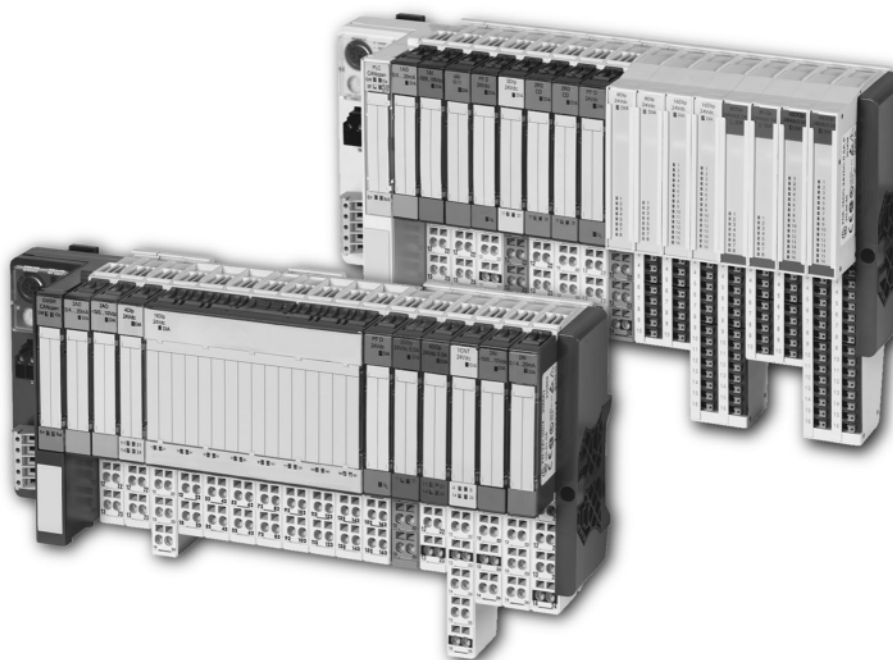

EAT•N

Powering Business Worldwide

Imprint

Manufacturer

Eaton Automation AG
Spinnereistrasse 8-14
CH-9008 St. Gallen
Switzerland
www.eaton-automation.com
www.eaton.com

Support

Region North America
Eaton Corporation
Electrical Sector
1111 Superior Ave.
Cleveland, OH 44114
United States
877-ETN-CARE (877-386-2273)
www.eaton.com

Other regions
Please contact your supplier or send an
E-mail to:
automation@eaton.com

Original manual

The German version of this document is the original manual.

Translations of the original manual

All non-German editions of this document are translations of the original manual.

Editorial department

Monika Jahn

Brand and product names

All brand and product names are trademarks or registered trademarks of the owner concerned.

Copyright

© Eaton Automation AG, CH-9008 St. Gallen

All rights reserved, also for the translation.

None of this document may be reproduced or processed, duplicated or distributed by electronic systems in any form (print, photocopy, microfilm or any other process) without the written permission of Eaton Automation AG, St. Gallen.

Subject to modifications.

Safety regulations

Before commencing the installation:

- Disconnect the power supply of the device.
- Ensure that devices cannot be accidentally restarted.
- Verify isolation from the supply.
- Earth and short circuit.
- Cover or enclose neighboring units that are live.
- Follow the engineering instructions of the device concerned.
- Only suitably qualified personnel in accordance with EN 50110-1/-2 (DIN VDE 0105 Part 100) may work on this device/system.
- Before installation and before touching the device ensure that you are free of electrostatic charge.
- The functional earth (FE) must be connected to the protective earth (PE) or to the potential equalization. The system installer is responsible for implementing this connection.
- Connecting cables and signal lines should be installed so that inductive or capacitive interference do not impair the automation functions.
- Install automation devices and related operating elements in such a way that they are well protected against unintentional operation.
- Suitable safety hardware and software measures should be implemented for the I/O interface so that a line or wire breakage on the signal side does not result in undefined states in the automation devices.
- Ensure a reliable electrical isolation of the low voltage for the 24 volt supply. Only use power supply units complying with IEC/HD 60364-4-41 (DIN VDE 0100 Part 410).
- Deviations of the mains voltage from the rated value must not exceed the tolerance limits given in the specifications, otherwise this may cause malfunction and dangerous operation.
- Emergency stop devices complying with IEC/EN 60204-1 must be effective in all operating modes of the automation devices. Unlatching the emergency-stop devices must not cause restart.
- Devices that are designed for mounting in housings or control cabinets must only be operated and controlled after they have been installed with the housing closed. Desktop or portable units must only be operated and controlled in enclosed housings.
- Measures should be taken to ensure the proper restart of programs interrupted after a voltage dip or failure. This should not cause dangerous operating states even for a short time. If necessary, emergency-stop devices should be implemented.
- Wherever faults in the automation system may cause damage to persons or property, external measures must be implemented to ensure a safe operating state in the event of a fault or malfunction (for example, by means of separate limit switches, mechanical interlocks etc.).
- The electrical installation must be carried out in accordance with the relevant regulations (e. g. with regard to cable cross sections, fuses, PE).

Safety regulations

- All work relating to transport, installation, commissioning and maintenance must only be carried out by qualified personnel. (IEC/HD 60364 (DIN VDE 0100) and national work safety regulations).
- All shrouds and doors must be kept closed during operation.

Table of contents

1	About this manual.....	9
1.1	Documentation concept.....	9
1.2	Description of symbols used.....	10
1.3	Overview.....	11
1.3.1	Prescribed use.....	11
1.3.2	Notes concerning planning /installation of this product.....	11
2	XI/ON philosophy.....	13
2.1	The basic concept.....	13
2.1.1	Flexibility.....	13
2.1.2	Compactness.....	13
2.1.3	Easy to handle.....	14
2.2	XI/ON components.....	15
2.2.1	Gateways.....	15
2.2.2	Power supply modules.....	17
2.2.3	Electronics modules.....	17
2.2.4	Base modules.....	19
2.2.5	End plate.....	20
2.2.6	End bracket.....	20
2.2.7	Jumpers.....	21
2.2.8	Marking material.....	21
2.2.9	Shield connection for gateways.....	22
2.2.10	Shield connection, 2-pole for analog modules.....	22
3	Ethernet.....	23
3.1	System description.....	23
3.1.1	Ethernet MAC-ID.....	23
3.1.2	IP address.....	23
3.1.3	Network classes.....	24
3.1.4	Data transfer.....	24
3.1.5	Checking the communication via "ping-signals".....	25
3.1.6	ARP (Address Resolution Protocol).....	26
3.1.7	Transmission media.....	26
4	Technical Features.....	27
4.1	General.....	27
4.2	Function.....	27
4.3	Technical data.....	28
4.3.1	Block diagram.....	29
4.3.2	General technical data of a station.....	29
4.3.3	Approvals and tests.....	32
4.3.4	Technical data for the push-in tension clamp terminals.....	32
4.4	Connection options at the gateway.....	33
4.4.1	Power supply.....	33
4.4.2	Field bus connection via Ethernet-switch.....	33
4.4.3	Service interface connection (mini USB female connector).....	34
4.5	Address setting.....	35
4.5.1	Default-settings for the gateway.....	35
4.5.2	Function of the DIP-switches.....	35
4.5.3	Address-setting via DIP-switches 2 ⁰ to 2 ⁷	37
4.5.4	Address setting via DHCP-mode.....	39
4.5.5	Address setting via BootP-mode.....	40

Table of contents

4.5.6	Address setting via PGM-mode	41
4.5.7	Address setting via the software "I/O-ASSISTANT"	42
4.6	Storing the station configuration	44
4.6.1	DIP-switch CFG	44
4.7	Status indicators/diagnostic messages gateway	45
4.7.1	Diagnostic messages via LEDs	45
5	Implementation of Modbus TCP	49
5.1	Common Modbus description	49
5.1.1	Protocol description	50
5.1.2	Data model	51
5.2	Implemented Modbus functions	53
5.3	Modbus registers	54
5.4	Structure of the packed in-/ output process data	59
5.4.1	Packed input-process data	60
5.4.2	Packed output process data	60
5.5	Data width of the I/O-modules in the modbus-register area	61
5.5.1	Register 100Ch: "Gateway-Status"	63
5.5.2	Register 1130h: "Modbus-connection-mode"	64
5.5.3	Register 1131h: "Modbus-connection time-out"	64
5.5.4	Register 0x113C and 0x113D: "Restore Modbus-connection parameter"	64
5.5.5	Register 0x113E and 0x113F: "Save Modbus-connection parameters"	64
5.6	The Service-Object	65
5.6.1	Indirect reading of registers	66
5.6.2	"Indirect writing of registers"	67
5.7	Bit areas: mapping of input-discrete- and coil-areas	68
5.8	Error behavior of outputs	68
5.9	Parameters of the modules	69
5.9.1	Analog input modules	69
5.9.2	Analog output modules	74
5.9.3	Technology modules	77
5.10	Diagnostic messages of the modules	95
5.10.1	Power supply modules	95
5.10.2	Analog input modules	96
5.10.3	Digital output modules	100
5.10.4	Analog output modules	101
5.10.5	Technology modules	102
6	Application example: Modbus TCP	109
6.1	Network configuration	109
6.2	Changing the IP address of a PC/ network interface card	110
6.2.1	Changing the IP address in Windows 2000/ Windows XP	110
6.2.2	Changing the IP address in Windows NT	111
6.2.3	Changing the IP address via I/O-ASSISTANT	112
6.2.4	Deactivating/ adapting the firewall in Windows XP	114
6.3	Communication examples: Modbus TCP	116
6.3.1	Reading-out the gateway-status	118
6.3.2	Reading-out the reference module list	119
6.3.3	Reading-out the actual module list	121
6.3.4	Reading-out the process image length (inputs)	122
6.3.5	Reading-out the packet process data (inputs)	123
6.3.6	Evaluation of the packed process data (inputs)	124
6.3.7	Setting of outputs	127
6.4	Parameterization of modules	129

6.5	Evaluation of module diagnostics.....	133
6.5.1	Group diagnosis within the process input data:	133
6.5.2	Module diagnosis (0xA000 to 0xA400)	134
7	Guidelines for station planning	137
7.1	Module arrangement.....	137
7.1.1	Combination possibilities in a XI/ON station.....	137
7.1.2	Random module arrangement.....	137
7.1.3	Complete planning	138
7.2	Maximum station extension.....	139
7.3	Power supply	142
7.3.1	Power supply to the gateway.....	142
7.3.2	Module bus refreshing	142
7.3.3	Creating potential groups	143
7.3.4	C-rail (cross connection)	143
7.3.5	Direct wiring of relay modules	145
7.4	Protecting the service interface on the gateway.....	146
7.5	Plugging and pulling electronics modules	146
7.6	Extending an existing station	146
7.7	Firmware download.....	147
7.7.1	DIP-switch position	147
8	Guidelines for Electrical Installation.....	149
8.1	General notes	149
8.1.1	General.....	149
8.1.2	Cable routing	149
8.1.3	Lightning protection	150
8.1.4	Transmission media	150
8.2	Potential relationships	151
8.2.1	General.....	151
8.3	Electromagnetic Compatibility (EMC).....	152
8.3.1	Ensuring electromagnetic compatibility	152
8.3.2	Grounding of inactive metal components	152
8.3.3	PE connection	152
8.3.4	Earth-free operation.....	152
8.3.5	Mounting rails.....	153
8.4	Shielding of cables	154
8.5	Potential compensation.....	155
8.5.1	Switching inductive loads.....	155
8.5.2	Protection against Electrostatic Discharge (ESD).....	155
9	Appendix.....	157
9.1	Data image of the technology modules	157
9.1.1	Counter module XN-1CNT-24VDC.....	157
9.1.2	Counter module XNE-2CNT-2PWM	170
9.1.3	RSxxx-module.....	179
9.1.4	SSI-module	183
9.1.5	SWIRE-module	189
9.2	Ident codes of the XI/ON modules.....	192
9.3	Glossary	194
10	Index.....	199

Table of contents

1 About this manual

1.1 Documentation concept

This manual contains all information about the XI/ON gateway for Modbus TCP of the product series XI/ON ECO (XNE-GWBR-2ETH-MB).

The following chapters contain a short XI/ON system description, a description of the field bus system Modbus TCP, exact information about function and structure of the gateway as well as all bus-specific information concerning the connection to automation devices, the maximum system extension etc.

The bus-independent I/O-modules for XI/ON as well as all further field bus independent chapters such as mounting, labelling etc. are described in separate manuals:

- MN05002010Z
User Manual XI/ON
Digital I/O-Modules, Supply Modules
- MN05002011Z
User Manual XI/ON
Analog I/O-Modules
- MN05002012Z
User Manual XI/ON
XN-1CNT-24VDC
- MN05002035Z
User Manual XI/ON
XNE-2CNT-2PWM
- MN05002013Z
User Manual XI/ON
XN-1RS232
- MN05002014Z
User Manual XI/ON
XN-1RS485/422
- MN05002015Z
User Manual XI/ON
XN-1SSI
- MN05002016Z
User Manual XI/ON
XNE-1SWIRE

Furthermore, the manual mentioned above contains a short description of the project planning and diagnostics software for Eaton I/O-systems, the software I/O-ASSISTANT.

1 About this manual

1.2 Description of symbols used

1.2 Description of symbols used



Warning

This sign can be found next to all notes that indicate a source of hazards. This can refer to danger to personnel or damage to the system (hardware and software) and to the facility.

This sign means for the operator: work with extreme caution.



Attention

This sign can be found next to all notes that indicate a potential hazard.

This can refer to possible danger to personnel and damages to the system (hardware and software) and to the facility.



Note

This sign can be found next to all general notes that supply important information about one or more operating steps.

These specific notes are intended to make operation easier and avoid unnecessary work due to incorrect operation.

1.3 Overview



Attention

Please read this section carefully. Safety aspects cannot be left to chance when dealing with electrical equipment.

This manual includes all information necessary for the prescribed use of the gateway XNE-GWBR-2ETH-MB. It has been specially conceived for personnel with the necessary qualifications.

1.3.1 Prescribed use

Appropriate transport, storage, deployment and mounting as well as careful operating and thorough maintenance guarantee the trouble-free and safe operation of these devices.



Warning

The devices described in this manual must be used only in applications prescribed in this manual or in the respective technical descriptions, and only with certified components and devices from third party manufacturers.

1.3.2 Notes concerning planning /installation of this product



Warning

All respective safety measures and accident protection guidelines must be considered carefully and without exception.

1 About this manual

1.3 Overview

2 XI/ON philosophy

2.1 The basic concept

XI/ON is a modular I/O system for use in industrial automation. It connects the sensors and actuators in the field with the higher-level master.

XI/ON offers modules for practically all applications:

- Digital input and output modules
- Analog input and output modules
- Technology modules (counters, RS232 interface...)

A complete XI/ON station counts as **one** station on the bus and therefore occupies **one** field bus address in any given field bus structure. A XI/ON station consists of a gateway, power supply modules and I/O modules.

The connection to the relevant field bus is made via the bus-specific gateway, which is responsible for the communication between the XI/ON station and the other field bus stations.

The communication within the XI/ON station between the gateway and the individual XI/ON modules is regulated via an internal module bus.



Note

The gateway is the only field bus dependent module on a XI/ON station. All other XI/ON modules are not dependent on the field bus used.

2.1.1 Flexibility

All XI/ON stations can be planned to accommodate the exact number of channels to suit your needs, because the modules are available with different numbers of channels in block and slice design.

A XI/ON station can contain modules in any combination, which means it is possible to adapt the system to practically all applications in automated industry.

2.1.2 Compactness

The slim design of the XI/ON modules (XN standard gateway 50.4 mm / 1.98 inch, XNE ECO gateway 34 mm / 1.34 inch, XN standard slice 12.6 mm / 0.49 inch, XNE ECO slice 13 mm / 0.51 inch and block 100.8 mm / 3.97 inch) and their low overall height favor the installation of this system in confined spaces.

2 XI/ON philosophy

2.1 The basic concept

2.1.3

Easy to handle



Note

All XNE ECO modules can be used with XN standard products with tension clamp connection technology. Possible combinations, see Chapter 7.1.1 Combination possibilities in a XI/ON station, Page 137.

XI/ON modules of the standard line (XN standard modules)

- All XI/ON modules of the standard line, with the exception of the gateway, consist of a base module and an electronics module.
- The gateway and the base modules are snapped onto a mounting rail. The electronics modules are plugged onto the appropriate base modules.
- The base modules of the standard line are designed as terminal blocks. The wiring is secured by tension clamp or screw connection.
- The electronics modules can be plugged or pulled when the station is being commissioned or for maintenance purposes, without having to disconnect the field wiring from the base modules.

XI/ON modules of the ECO line (XNE ECO modules)

- The XNE ECO electronics modules combine base module and electronics module in one housing.
- The gateway and the electronics modules are snapped onto a mounting rail.
- The electronics modules of the ECO line are designed as terminal blocks. The wiring is secured by "push-in" spring-type terminal.

2.2 XI/ON components

2.2.1 Gateways

The gateway connects the field bus to the I/O modules. It is responsible for handling the entire process data and generates diagnostic information for the higher-level master and the software tool I/O-ASSISTANT.

XNE ECO gateways

The XNE ECO gateways enlarge the product portfolio of XI/ON. They offer an excellent cost/performance ratio.

Further advantages of the XNE ECO gateways:

- At the moment available for PROFIBUS-DP, CANopen, Modbus TCP and EtherNet/IP
- Low required space: width 34 mm/ 1.34 inch
- Integrated power supply
- Can be combined with all existing XN standard modules (with tension clamp connection technology) and XNE ECO modules
- Simple wiring of the field bus connection via "Push-in" tension clamp terminals or via RJ45-connectors of Ethernet gateways
- Automatic bit rate detection for PROFIBUS-DP and CANopen
- Setting of field bus address and bus terminating resistor (PROFIBUS-DP, CANopen) via DIP-switches
- Service interface for commissioning with I/O-ASSISTANT

Figure 1:
Gateway
XNE-GWBR-
2ETH-MB



2 XI/ON philosophy

2.2 XI/ON components

XN standard gateways

The standard line of XI/ON contains gateways with and gateways without an integrated power supply unit:

- Gateways with an integrated power supply unit: XN-GWBR-...
- Gateways without an integrated power supply unit: XN-GW-...

The integrated power supply unit U_{SYS} feeds the gateway and in a limited range (note the permitted current I_{MB}) the communication part of the connected I/O modules. Additionally, the field voltage distributed via the system interne current rail system is fed by the further voltage U_L . Because of this, a XN-GWBR gateway does not require the XN-BR-24VDC-D module which is necessary with XN-GW gateways.



Note

The gateway types XN-GW-... need an additional power supply module (bus refreshing module) which feeds the gateway and the connected I/O modules.

Figure 2:
Gateway
example:
XN-GWBR-
PBDP



2.2.2 Power supply modules

The power supply for gateways and I/O modules is provided by the power supply modules; therefore, it is not necessary to supply each individual module with a separate voltage.

Figure 3:
Power supply
module with
base module

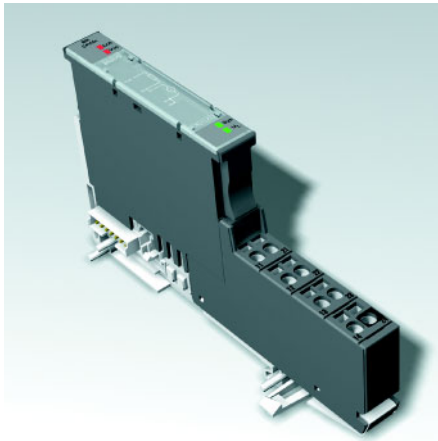

2.2.3 Electronics modules

The electronics modules contain the I/O-functions of the XI/ON modules (power supply modules, digital and analog input/output modules, and technology modules).

XN standard electronics modules

The XN standard electronics modules are plugged onto the base modules and are not directly connected to the wiring and can be plugged or pulled when the station is being commissioned or for maintenance purposes, without having to disconnect the field wiring from the base modules.

Figure 4:
XN standard
electronics
module in slice
design (left) and
in block design
(right)

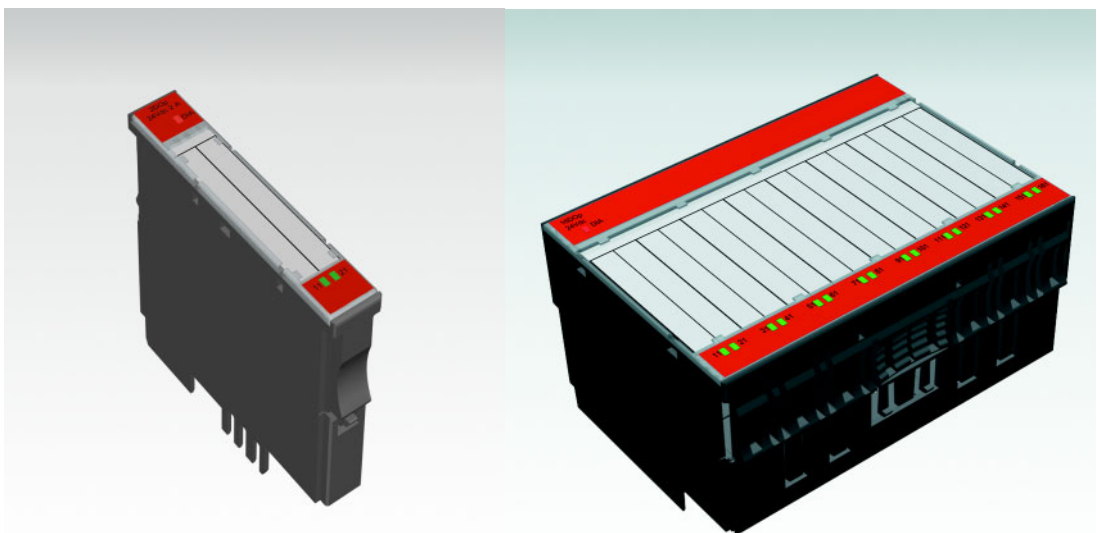

2 XI/ON philosophy

2.2 XI/ON components

XNE ECO electronics modules

XNE ECO electronics modules with a high signal density and low channel price expand the XI/ON I/O bus terminal system.

Depending on type, up to 16 digital inputs and outputs can be connected on only 13 mm. This high connection density considerably reduces the mounting width required for typical applications.

All advantages at a glance:

- Space saving thanks to up to 16 channels on 13 mm/ 0.51 inch width
- Cost saving thanks to electronics with integrated connection level
- High signal density
- Tool-less connection via "push-in" spring-type terminal technology for simple and fast mounting
- Flexible combinable with:
 - XN standard electronics modules with base modules with tension clamp connection technology,
 - XN standard gateways with an integrated power supply unit (XN-GWBR-...) and
 - XNE ECO gateways
- Simple assembly reduces error sources

Figure 5:
XNE ECO elec-
tronics module



2.2.4 Base modules

For the XN standard electronics modules, the field wiring is connected to the base modules. The base modules are constructed as terminals in block and slice designs. Base modules are available in versions with 3, 4 or 6 connection levels in tension clamp or in screw connection technology.

Figure 6:
Base module
with tension
clamp connection

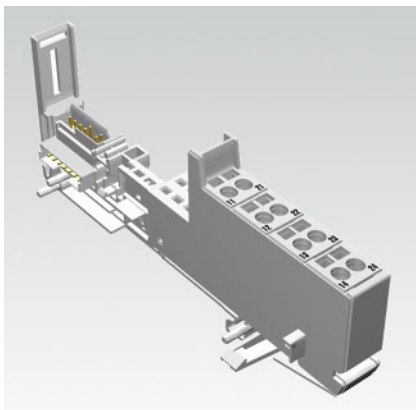

Figure 7:
Base module
with screw connection

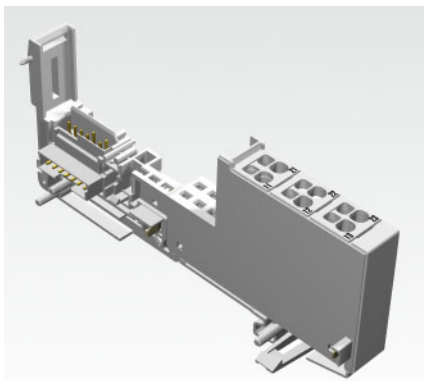
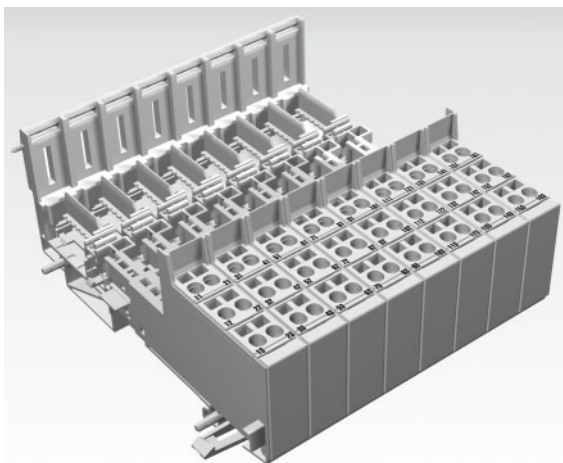

Figure 8:
Base module in
block design



2 XI/ON philosophy

2.2 XI/ON components

2.2.5 End plate

An end plate on the right-hand side physically completes the XI/ON station. An end bracket mounted into the end plate ensures that the XI/ON station remains secure on the mounting rail even when subjected to vibration.

Figure 9:
End plate

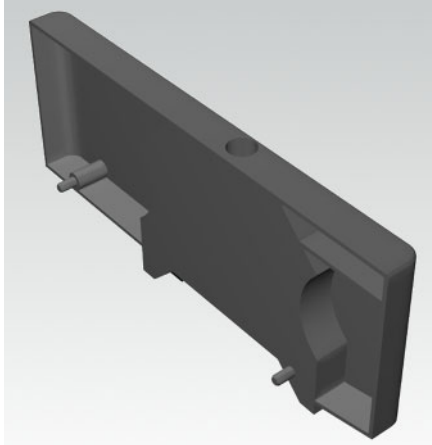

2.2.6 End bracket

A second end bracket to the left of the gateway is necessary, as well as the one mounted into the end plate to secure the XI/ON station.

Figure 10:
End bracket

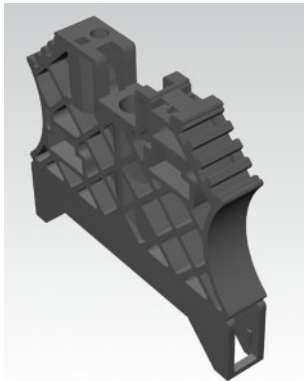

Note

The scope of delivery of each gateway contains an end plate and two end brackets.

2.2.7 Jumpers

Jumpers (QVRs) are used to bridge a connection level of a base module with 4 connection levels. They can be used to connect potentials in relay modules (bridging the relay roots); thus considerably reducing the amount of wiring.

Figure 11:
Jumpers

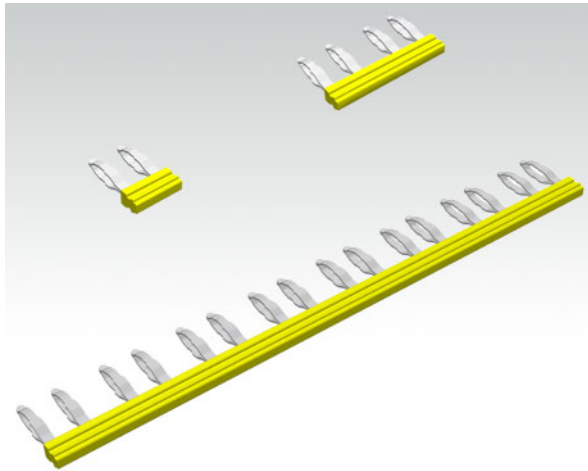

2.2.8 Marking material

- Labels: for labeling electronics modules.
- Markers: for colored identification of connection levels of base modules and XN electronics modules.

Figure 12:
Marking material

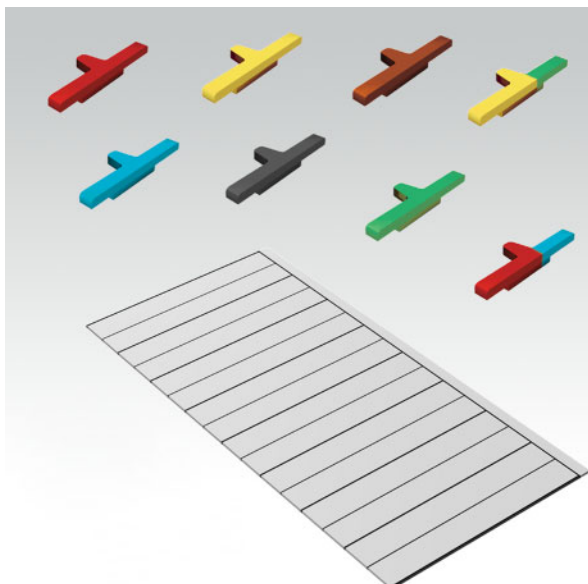

2.2.9 Shield connection for gateways



Note

The gateway attachment is only suitable for XN-GW-PBDP-1.5MB and XN-GW-CANOPEN.

If the gateway is wired directly to the field bus, it is possible to shield the connection using an attachment (SCH-1-WINBLOC) on the gateway.

Figure 13:
Shield connection (gateway)

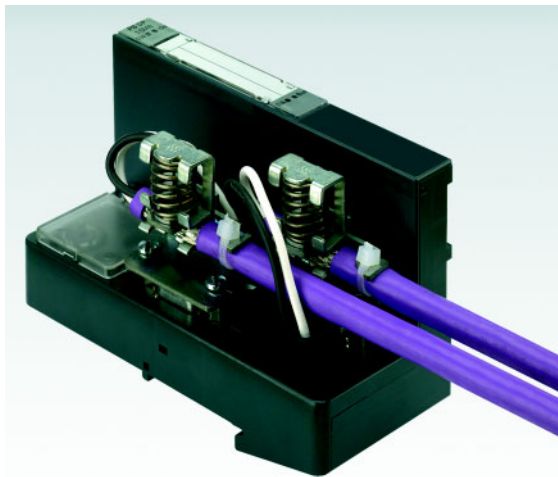

2.2.10 Shield connection, 2-pole for analog modules

The 2-pole shield connection can be used to connect signal-cable shielding to the base modules of analog input and output modules.

Figure 14:
Shield connection, 2-pole for analog modules

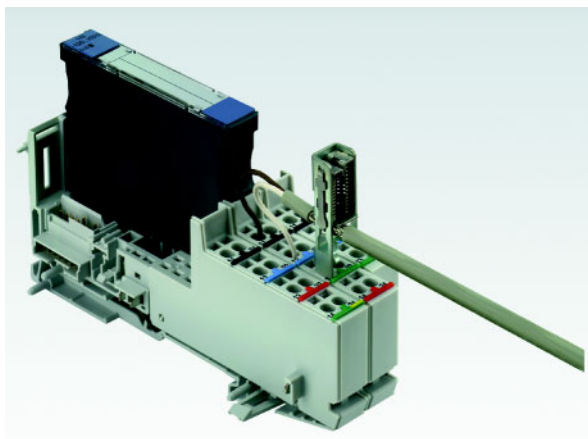

3 Ethernet

3.1 System description

Originally developed by DEC, Intel and Xerox (as DIX standard) for data transmission between office equipment, Ethernet stands for the IEEE 802.3 CSMA/CD specification published in 1985.

The rapid increase of application and the worldwide use of this technology enables problem-free and above all cost-effective connection to existing networks.

3.1.1 Ethernet MAC-ID

The Ethernet MAC-ID is a 6-byte-value which serves to uniquely identify an Ethernet device. The MAC-ID is determined for each device by the IEEE (Institute of Electrical and Electronics Engineers, New York).

The first 3 bytes of the MAC-ID contain a manufacturer identifier. The last 3 bytes can be chosen freely by the manufacturer for each device and contain a unique serial number.

A label on the Eaton modules shows the respective MAC-ID.

In addition to this, the MAC-ID can be read out using the software tool "I/O-ASSISTANT".

3.1.2 IP address

Each Ethernet-host receives its own IP address. In addition to that the node knows its netmask and the IP address of the default gateway.

The IP address is a 4-byte-value which contains the address of the network to which the node is connected as well as the host address in the network.

The IP address of the gateway XNE-GWBR-2ETH-MB is predefined as follows:

IP address:	192.168.1.×××
netmask:	255.255.255.0
gateway:	192.168.1.1

The netmask shows which part of the IP address defines the network as well as the network class and which part of the IP address defines the single node in the network.

In the example mentioned above, the first 3 bytes of the IP address define the network. They contain the subnet-ID 192.168.1.

The last byte of the IP address defines the node's address within the network.



Note

In order to build up the communication between a PC and an Ethernet-module, both have to be nodes of the same network.

If necessary, the nodes' network addresses have to be adapted one to another.

Please read Chapter 6.2 Changing the IP address of a PC/ network interface card, Page 110.

3 Ethernet

3.1 System description

3.1.3 Network classes

The available networks are divided into the different network classes A, B, and C.

Table 1:
Network classes

Class	Network addresses	Bytes for net address	Bytes for host address	No. of the possible networks/ hosts
A	1.xxx.xxx.xxx- 126.xxx.xxx.xxx	1	3	$126/2^{24}$
B	128.0.xxx.xxx - 191.255.xxx.xxx	2	2	$2^{14}/2^{16}$
C	192.0.0.xxx - 223.255.255.xxx	3	1	$2^{21}/256$

According to their predefined address 192.168.1.xxx the XI/ON gateways are thus nodes of a Class C network.

3.1.4 Data transfer

The data are transferred from a transmitter to a receiver via the Ethernet. This data transfer uses no acknowledgement of reception, which means data telegrams can get lost. Data transfer via Ethernet without any protocol implementation can thus not be absolutely safe.

In order to assure a safe transmission of data, frame-protocols like TCP/IP are used.

Figure 15:
Telegram structure

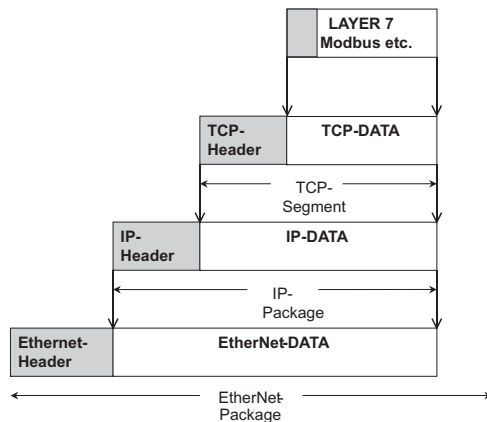

IP (Internet Protocol)

The Internet Protocol is a connection-free transport protocol. The protocol does not use acknowledgement messages, telegrams can get lost. It is thus not suitable for safe data transfer. The main functions of the internet protocol are the addressing of hosts and the fragmentation of data packages.

TCP (Transmission Control Protocol)

The Transmission Control Protocol (TCP) is a connection-oriented transport protocol and is based on the Internet Protocol. A safe and error-free data transport can be guaranteed by means of certain error diagnostic mechanisms as for example acknowledgement and time monitoring of telegrams.

Modbus TCP

In Ethernet TCP/IP networks, Modbus TCP uses the Transmission Control Protocol (TCP) for the transmission of the Modbus application protocol.

All parameters and data are embedded in the user data of the TCP-telegram using the encapsulation protocol: the client generates a special header (MBAP = Modbus Application Header), which enables the server to clearly interpret the received Modbus-parameters and -commands.

The Modbus protocol is thus part of the TCP/IP-protocol.



Note

Chapter 5, Page 49 contains a more detailed description of Modbus TCP.

3.1.5 Checking the communication via "ping-signals"

You can check the communication between nodes in a network using ping-signals in the DOS-prompt of your PC.

For that purpose, please enter the command "ping" and the IP address of the network node to be checked.

If the node answers the ping-signal, it is ready for communication and takes part in the data transfer.

Figure 16:
ping-signal

```
C:\WINDOWS\system32\cmd.exe
Microsoft Windows XP [Version 5.1.2600]
(C) Copyright 1985-2001 Microsoft Corp.
'0' is not recognized as an internal or external command,
operable program or batch file.

C:\>ping 192.168.1.100

Pinging 192.168.1.100 with 32 bytes of data:

Reply from 192.168.1.100: bytes=32 time=1ms TTL=60
Reply from 192.168.1.100: bytes=32 time<1ms TTL=60
Reply from 192.168.1.100: bytes=32 time<1ms TTL=60
Reply from 192.168.1.100: bytes=32 time=1ms TTL=60

Ping statistics for 192.168.1.100:
    Packets: Sent = 4, Received = 4, Lost = 0 (0% loss),
    Approximate round trip times in milli-seconds:
        Minimum = 0ms, Maximum = 1ms, Average = 0ms

C:\>
```

3 Ethernet

3.1 System description

3.1.6 ARP (Address Resolution Protocol)

In each TCP/IP-capable computer, ARP serves to clearly assign the worldwide unique hardware addresses (MAC-IDs) to the single IP addresses of the network nodes via internal tables.

Using ARP in the DOS-prompt, every node in a network can be clearly identified via its MAC-ID.

- Write a ping command for the respective station/ IP address:
(example: "x:\ping 192.168.1.100").
- Via the command "x:\arp -a" the MAC-ID for this IP address is determined. This MAC-ID clearly identifies the network node.

Figure 17:
Determination
of the MAC-ID
of a XI/ON module via ARP

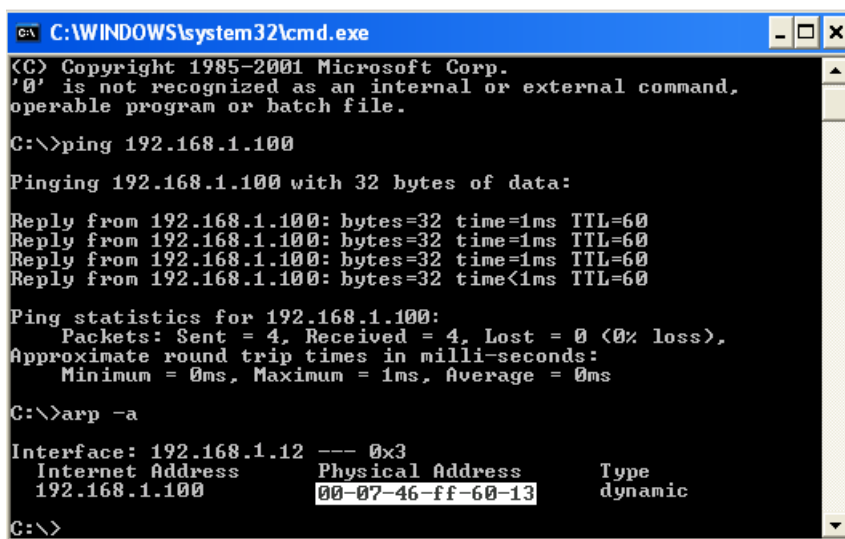

```
C:\WINDOWS\system32\cmd.exe
(C) Copyright 1985-2001 Microsoft Corp.
'0' is not recognized as an internal or external command,
operable program or batch file.
C:\>ping 192.168.1.100

Pinging 192.168.1.100 with 32 bytes of data:

Reply from 192.168.1.100: bytes=32 time=1ms TTL=60
Reply from 192.168.1.100: bytes=32 time=1ms TTL=60
Reply from 192.168.1.100: bytes=32 time=1ms TTL=60
Reply from 192.168.1.100: bytes=32 time<1ms TTL=60

Ping statistics for 192.168.1.100:
    Packets: Sent = 4, Received = 4, Lost = 0 (0% loss),
    Approximate round trip times in milli-seconds:
        Minimum = 0ms, Maximum = 1ms, Average = 0ms

C:\>arp -a

Interface: 192.168.1.12 --- 0x3
    Internet Address      Physical Address      Type
    192.168.1.100         00-07-46-ff-60-13    dynamic
C:\>
```

3.1.7 Transmission media

For a communication via Ethernet, different transmission media can be used (see Chapter 8.1.4, Page 150).

4 Technical Features

4.1 General

This chapter contains the general technical description of the gateway XNE-GWBR-2ETH-MB for Ethernet. The following technical features are independent of the implemented protocol. The chapter describes: the technical data, the connection possibilities, the addressing of the gateway etc.

4.2 Function

The gateway is the connection between the XI/ON I/O-modules and the Ethernet network. It handles the entire process data traffic between the I/O-level and the field bus and generates diagnostic information for higher-level nodes and the software tool I/O-ASSISTANT.

4 Technical Features

4.3 Technical data

4.3 Technical data

Figure 18:
Top view

- A** LEDs for XI/ON-module bus
- B** service-interface
- C** DIP-switch for field bus addressing
- D** DIP-switch for operation mode
- E** DIP-switch for configuration storage
- F** LED for the Modbus-communication
- G** EtherNet-switch with EtherNet-LEDs
- H** Push-in tension clamps for field supply
- I** Push-in tension clamps for system supply

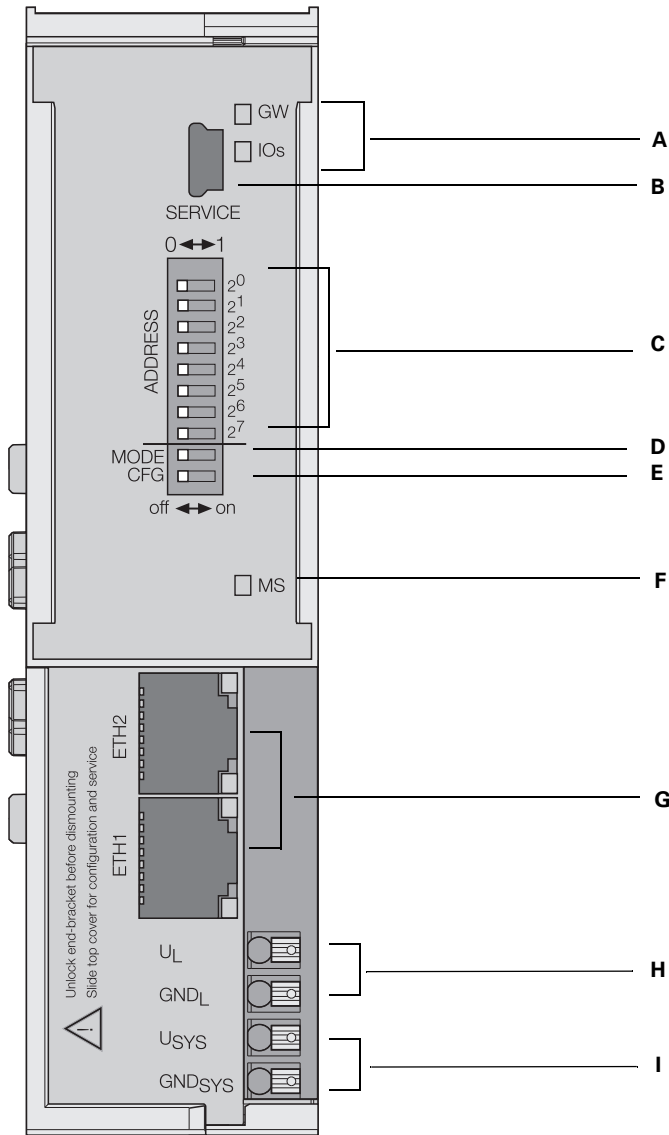

4.3.1 Block diagram

Figure 19:
Block diagram
XNE-GWBR-
2ETH-MB

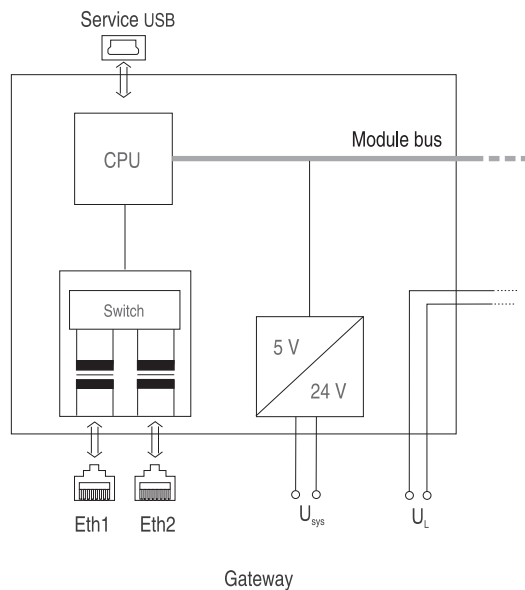

4.3.2 General technical data of a station



Attention

The auxiliary power supply must comply with the stipulations of SELV (Safety Extra Low Voltage) according to IEC 60364-4-41.

Table 2:
General technical data of a station

Maximum system extension	32 modules (XN, XNE) in slice design or max. length of station: 1 m
Supply voltage/ auxiliary voltage	
Field supply	
U_L nominal value (range)	24 V DC (18 to 30 V DC)
I_L max. field current	8 A
Insulation voltage (U_L to U_{SYS} / U_L to field bus / U_L to FE)	500 V _{rms}
System supply	
U_{SYS} nominal value (range)	24 V DC (18 to 30 V DC)
I_{SYS} (at maximum station extension → see Chapter 7.2, Page 139)	max. 600 mA
I_{MB} (supply to the module bus participants)	400 mA
Insulation voltage (U_{SYS} to U_L / U_{SYS} to field bus / U_{SYS} to FE)	500 V _{rms}

4 Technical Features

4.3 Technical data

Residual ripple	according to IEC/EN 61131-2
Voltage anomalies	according to IEC/EN 61131-2
Connection technology	Push-in tension clamp terminals, LSF from Weidmueller
Physical interfaces	
Field bus	
Protocol	Ethernet
Transmission rate	10/100 MBit
Passive fibre-optic-adapters can be connected	current consumption max. 100 mA
Field bus connection	RJ45-female connector, RJ45-male connector
Field bus shielding connection	via Ethernet cable
Address setting	via DIP-switches (2^0 to 2^7)
Service interface	mini USB
Insulation voltages	
U_{SYS} to service interface USB	-
U_L , U_{SYS} to Ethernet	500 V_{rms}
ETH1 to ETH2	500 V_{rms}
Ambient conditions	
Ambient temperature	
Operating temperature	0 to +55 °C / 32 to 131 °F
Storage temperature	-25 to +85 °C / 13 to 185 °F
Relative humidity according to IEC/EN 60068-2-30	5 to 95 % (indoor), Level RH-2, no condensation (storage at 45 °C, no function test)
Climatic tests	according to IEC/EN 61131-2
Resistance to vibration according to IEC/EN 60068-2-6	
10 to 57 Hz, constant amplitude 0.075 mm / 0.003 inch, 1g	Yes
57 to 150 Hz, constant acceleration 1 g	Yes
Mode of vibration	Frequency sweeps with a change in speed of 1 Octave/min
Period of oscillation	20 frequency sweeps per axis of coordinate

Shock resistant according to IEC/EN 60068-2-27	18 shocks, sinusoidal half-wave 15 g peak value/11 ms, in each case in \pm direction per space coordinate
Resistance to repetitive shock according to IEC/EN 60068-2-29	1 000 shocks, half-sinus 25 g peak value/6 ms, in each case in \pm direction per space coordinate
Topple and fall according to IEC/EN 60068-2-31 and free fall according to IEC/EN 60068-2-32	
Height of fall (weight < 10 kg)	1.0 m
Height of fall (weight 10 to 40 kg)	0.5 m
Test runs	7

Device with packaging, electrically tested printed-circuit board.

A The use in residential areas may lead to functional errors. Additional suppression measures are necessary!

Electromagnetic compatibility (EMC) according to IEC/EN 61000-6-2 (Industry)

Static electricity according to IEC/EN 61000-4-2

Discharge through air (direct) 8 kV

Relay discharge (indirect) 4 kV

Electromagnetic HF fields according to IEC/EN 61000-4-3 10 V/m

Conducted interferences induced by HF fields according to IEC/EN 61000-4-6 10 V

Fast transients (Burst) according to IEC/EN 61000-4-4 1 kV / 2 kV

Emitted interference according to IEC/EN 61000-6-4 (Industry)

Emitted interference according to IEC/CISPR 11 / EN 55011 Class A **A**



Warning

This device can cause radio disturbances in residential areas and in small industrial areas (residential, business and trading). In this case, the operator can be required to take appropriate measures to suppress the disturbance at his own cost.



Note

For testing high energie surge (according to IEC/EN 61000-4-5 and product standard IEC/EN 61131-2) a cable lenght of digital and analogue I/O ports is specified with < 30 m.

4 Technical Features

4.3 Technical data

4.3.3 Approvals and tests

Table 3:
Approvals and tests of a XI/ON station

Description	
Approvals	
cUL	in preparation
Tests (IEC/EN 61131-2)	
Cold	IEC/EN 60068-2-1
Dry heat	IEC/EN 60068-2-2
Damp heat, cyclic	IEC/EN 60068-2-30
Operational life MTBF	120 000 h
Pollution severity according to IEC/EN 60664 (IEC/EN 61131-2)	2
Protection class according to IEC/EN 60529	IP 20

4.3.4 Technical data for the push-in tension clamp terminals

Table 4:
Technical data for the Push-in tension clamp terminals

Designation	
Measurement data	according to VDE 0611 Part 1/8.92 / IEC/EN 60947-7-1
Protection class	IP20
Insulation stripping length	8.0 to 9.0 mm / 0.32 to 0.36 inch
Max. wire range	0.14 to 1.5 mm ² / 0.0002 to 0.0023 inch ² / 24 to 16 AWG
Crimpable wire	
"e" solid core H 07V-U	0.25 to 1.5 mm ² / 0.0004 to 0.0023 inch ²
"f" flexible core H 07V-K	0.25 to 1.5 mm ² / 0.0004 to 0.0023 inch ²
"f" with ferrules without plastic collar according to DIN 46228-1 (ferrules crimped gas-tight)	0.25 to 1.5 mm ² / 0.0004 to 0.0023 inch ²
"f" with ferrules with plastic collar according to DIN 46228-1 (ferrules crimped gas-tight)	0.25 to 0.75 mm ² / 0.0004 to 0.0012 inch ²
Test finger according to IEC/EN 60947-1	A1

4.4 Connection options at the gateway

The field bus connection is realized via an integrated RJ45-Ethernet-switch, the connection of the power supply via push-in tension clamps.

Figure 20:
Connection level at the gateway

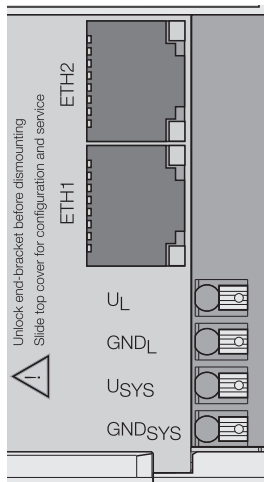

4.4.1 Power supply

The XNE-GWBR-2ETH-MB provides an integrated power supply unit and push-in tension clamps for:

- field supply (U_L , GND_L)
- system supply (U_{SYS} , GND_{SYS})

4.4.2 Field bus connection via Ethernet-switch

The XI/ON-ECO-gateways for Ethernet provide an integrated RJ45-Ethernet-switch.

Figure 21:
RJ45-female connector

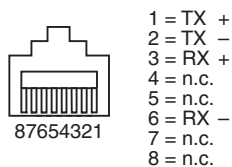

4 Technical Features

4.4 Connection options at the gateway

4.4.3 Service interface connection (mini USB female connector)

The service interface is used to connect the gateway to the project planning and diagnostic software I/O-ASSISTANT.

The service interface is designed as a 5 pole mini-USB-connection.

In order to connect the gateway's service-interface to the PC, a commercial cable with mini USB connector is necessary.

Figure 22:
Mini-USB-
female connec-
tor at the gate-
way

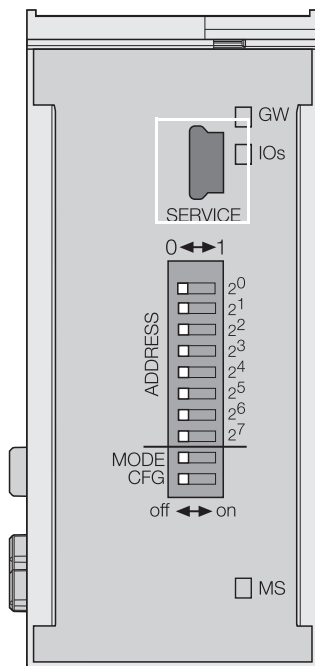

4.5 Address setting

4.5.1 Default-settings for the gateway

The gateway's default settings are the following:

IP-address: 192.168.1.254
subnet mask: 255.255.255.000
default-gateway: 192.168.1.001



Note

The gateway can be reset to these default settings by the user at any time. To reset the gateway, please set the DIP-switches 2⁰ to 2⁷ to "0" followed by a power-on reset.



Attention

After every change of the address-mode, a voltage reset must be carried out.

4.5.2 Function of the DIP-switches

The DIP-switches for address setting, operation mode setting and for the storage of the station configuration are located under the gateway's upper label.

Figure 23:
DIP-switches at
the gateway

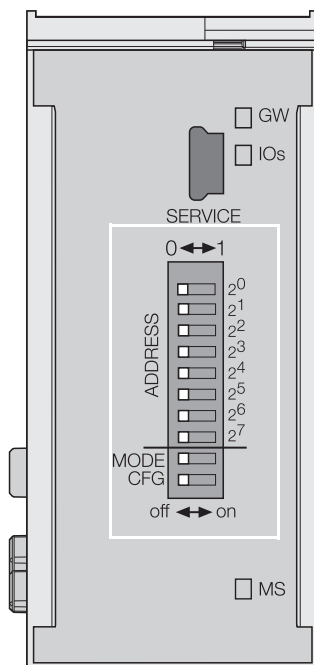

4 Technical Features

4.5 Address setting

Table 5:
Meaning of the
DIP-switches

Designation	Function
2 ⁰ - 2 ⁷	Address-switch for setting the last byte of the gateway's IP-address, only if the "MODE" switch is set to "OFF" (see Table 6: Combinations for the address-switch settings, Page 36).
MODE	Depending on its setting, this switch changes the function of address-switches 2 ⁰ - 2 ⁷ (see Table 6: Combinations for the address-switch settings, Page 36).
CFG	Switching from "OFF" to "ON" activates the storage of the station configuration (see Chapter 4.6 Storing the station configuration, Page 44.)



Note

The position of the DIP-switches 2⁷, CFG and MODE is also important for the download of new firmware to the gateway. Please read Chapter 7.7 Firmware download, Page 147.

Table 6:
Combinations
for the address-
switch settings

Address switch 2 ⁰ - 2 ⁷	Address switch "MODE"	Function
0	OFF	Setting the „Default-settings for the gateway“.
1-254	OFF	„Address-setting via DIP-switches 20 to 27“ (Setting the last byte of the gateway's IP-address)
1	ON	Gateway-„Address setting via DHCP-mode“
2	ON	Gateway-„Address setting via BootP-mode“
4	ON	Gateway-„Address setting via PGM-mode“
8	ON	invalid

4.5.3 Address-setting via DIP-switches 2⁰ to 2⁷

Addresses from 1 to 254 can be set. The addresses 0 and 255 are used for Broadcast-messages in the subnet.

The DIP-switch MODE has to be set to "OFF"

i Note
All other network settings are stored in the module's non-volatile EEPROM and can not be changed.

The gateway's field bus address results from the addition of the valences (2⁰ to 2⁷) of the active DIP-switches (position = 1).

i Note
Pull the label upwards out of the housing in order to reach the DIP-switches.

Example:

Bus address 50 = 0x32 = 00110010

Figure 24:
Address setting

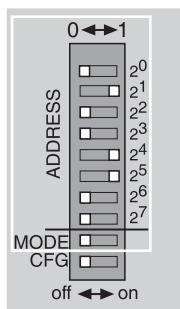

i Note
The internal module bus does not require any addressing.

⚠ Attention
The settings carried out via DIP-switches 2⁰ and 2⁷ are not stored in the module's EEPROM. Thus, they will get lost in case of a subsequent address-assignment via a BootP, DHCP or PGM.

⚠ Attention
After changing the position of the DIP-switches, a voltage reset must be carried out to store the new address.

4 Technical Features

4.5 Address setting

LED-behavior

During the module's start-up, the "MS" LED shortly becomes constant red. After the successful start-up, the LED begins to flash green and the station is then ready for communication.

4.5.4 Address setting via DHCP-mode

The address setting is carried out by a DHCP-server in the network after the start-up of the gateway.

In order to activate the DHCP-mode, the DIP-switch MODE is set to "ON", the address-switches 2^0 to 2^7 to address "1" (siehe Table 6: Combinations for the address-switch settings, Page 36).

Figure 25:
DHCP-mode

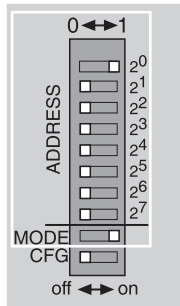

Note

The subnet mask as well as the default IP address assigned to the gateway by the DHCP-server are stored in the gateway's non-volatile EEPROM.

If the gateway is subsequently switched to another address-mode, the settings carried out via DHCP (IP address, subnet mask, etc) will be taken from the module's EEPROM.



Attention

After every change of the address-mode, a voltage reset must be carried out.

DHCP supports three mechanisms for IP address allocation:

- In "automatic allocation", the DHCP-server assigns a permanent IP address to a client.
- In "dynamic allocation", DHCP assigns an IP address to a client for a limited period of time. After this time or until the client explicitly relinquishes the address, the address can be re-assigned.
- In "manual allocation", a client's IP address is assigned by the network administrator, and DHCP is used simply to convey the assigned address to the client.

LED-behavior

During its start-up, the module waits for the address setting via DHCP-/BootP-server. This is indicated by the red flashing "MS" LED. The LED begins to flash green, as soon as the address setting via the server is completed. The station is ready for communication.

4 Technical Features

4.5 Address setting

4.5.5 Address setting via BootP-mode

The address setting is carried out by a BootP-server in the network after the start-up of the gateway.

In order to activate the BootP-mode, the DIP-switch MODE is set to "ON", the address switches 2^0 to 2^7 to address "2" (see Table 6: Combinations for the address-switch settings, Page 36).

Figure 26:
BootP

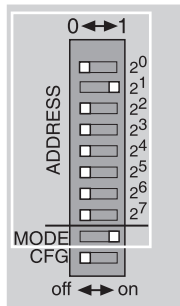

Note

The subnet mask as well as the default IP address assigned to the gateway by the BootP-server are stored in the gateway's non-volatile EEPROM.

If the gateway is subsequently switched to another address-mode, the settings carried out via BootP (IP address, subnet mask, etc.) will be taken from the module's EEPROM.



Attention

After every change of the address-mode, a voltage reset must be carried out.

LED-behavior

During its start-up, the module waits for the address setting via DHCP-/BootP-server. This is indicated by the red flashing "MS" LED. The LED begins to flash green, as soon as the address setting via the server is completed. The station is ready for communication.

4.5.6 Address setting via PGM-mode

The PGM-mode enables the access of I/O-ASSISTANT to the gateway's network settings (see also Chapter 4.5.7 Address setting via the software "I/O-ASSISTANT", Page 42).

In order to activate the PGM-mode, the DIP-switch MODE is set to "ON", the address switches 2^0 to 2^7 to address "4" (see Table 6: Combinations for the address-switch settings, Page 36).

Figure 27:
PGM

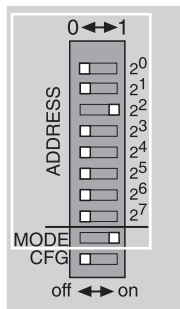

Note

In the PGM-mode, all changes in the network settings (IP address, subnet mask, etc.) will be taken from the gateway and stored non-volatilely in the internal EEPROM.



Attention

After every change of the address-mode, a voltage reset must be carried out.

LED-behavior

During its start-up, the module waits for the address setting via DHCP-/BootP-server. This is indicated by the red flashing "MS" LED. The LED begins to flash green, as soon as the address setting via the server is completed. The station is ready for communication.

4 Technical Features

4.5 Address setting

4.5.7 Address setting via the software "I/O-ASSISTANT"

The software I/O-ASSISTANT enables direct access to the Ethernet-gateway via the Ethernet-network.

Naturally, the access to the single station via the service interface at the gateway is possible as well.

Figure 28:
Interface
Ethernet

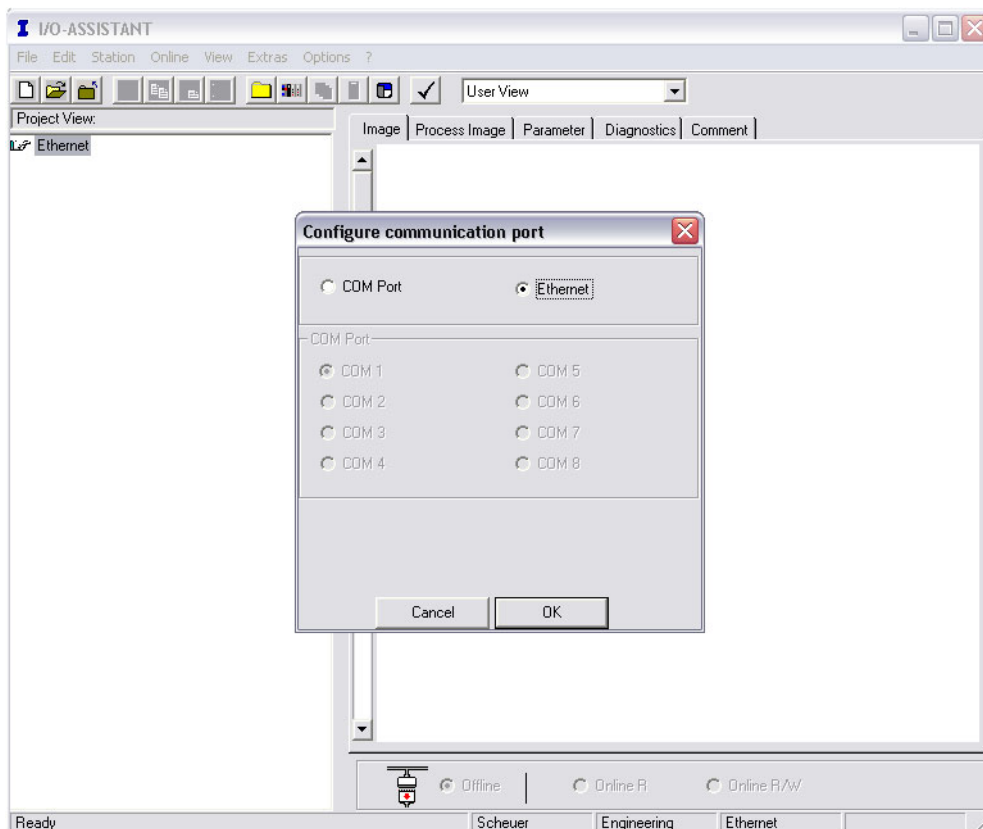

The IP address as well as the subnet mask of the Ethernet gateways can be changed according to the application by using the integrated Address Tool.



Note

The access of the I/O-ASSISTANT to the gateway is only possible if the gateway is operated in PGM-mode (see also Chapter 4.5.6 Address setting via PGM-mode, Page 41).

Figure 29:
Opening the
Address-Tool

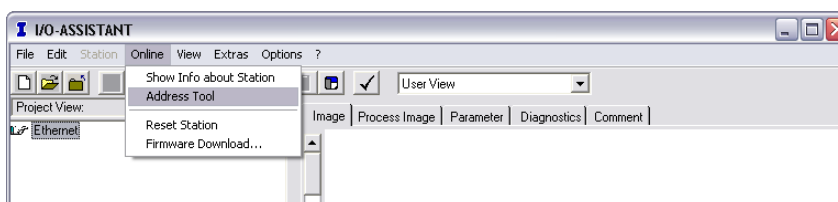
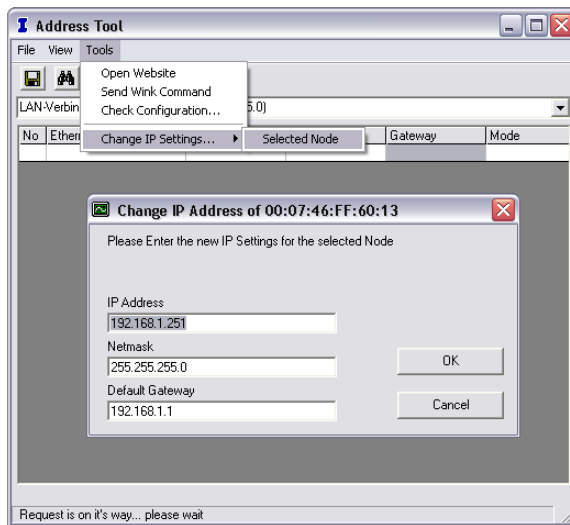

Figure 30:
Changing the
IP address



Attention

Please observe that, if the system integrated Windows-firewall is activated, difficulties may occur during the communication between the gateway and the Address-tool. The firewall may possibly inhibit the access of the tool on Ethernet.

4 Technical Features

4.6 Storing the station configuration

4.6 Storing the station configuration

4.6.1 DIP-switch CFG

The DIP-switch "CFG" at the gateway serves to take-over the Current Configuration of the XI/ON-station as Required Configuration to the gateway's non-volatile memory.

Figure 31:
DIP-switch for
storing the
station configu-
ration

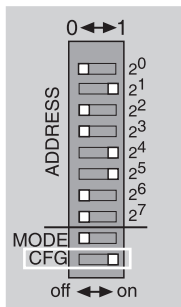

Switching from OFF to ON starts the storage of the Current Configuration as the Required Configuration (Reference configuration).

Procedure:

Switching the DIP-switch "CFG" from OFF to ON

- Starting of the storage process
- LED IOs flashes green (1 HZ)
- LED IOs shortly lits up orange
- storage process active
- set back the DIP-switch from ON to OFF
- storage process terminated successfully, if the LEDs IOs and GW are constant green.



Note

If the DIP-switch is not set back, the gateway will continiously restart the storage process. Only setting the switch back from ON to OFF will terminate this process.

4.7 Status indicators/diagnostic messages gateway

The gateway sends the following diagnostic messages:

- undervoltage monitoring for system- and field supply,
- monitoring of the station status,
- monitoring of the communication via the internal module bus,
- monitoring of the communication to Ethernet
- monitoring of the gateway status

Diagnostic messages are displayed in two different ways:

- via the LEDs
- via the respective configuration software (I/O-ASSISTANT) or Modbus-Client

4.7.1 Diagnostic messages via LEDs

Every XI/ON gateway displays the following statuses via LEDs:

- 2 LEDs for module bus communication (module bus LEDs): **GW** and **IOs**
- 1 LED for the Ethernet communication (field bus LEDs): **MS**
- 2 LEDs for the state of the Ethernet connection (at the Ethernet connectors ETH1 and ETH2)

Table 7:
LED-displays

LED	Status	Meaning	Remedy
GW	Off	CPU not supplied.	Check the voltage supply U_{SYS} at the gateway.
	Green	Firmware active, gateway ready to operate and transmit	-
	Green flashing, 1 Hz	Firmware not active.	If in addition the " IOs " LED is red, a Firmware download is necessary.
	Red	CPU is not ready, V_{CC} level is not within the required range. → possible reasons: – too many modules connected to the gateway – short circuit in connected module – hardware error in gateway	– Check wiring at the gateway and the voltage supply. – Dismount modules – Replace the gateway.
	Red/green flashing, 4 Hz	WINK-Command active	The software I/O-ASSISTANT is executing a WINK command on the device. This command is executed in order to find out which network node is accessed.

4 Technical Features

4.7 Status indicators/diagnostic messages gateway

Table 7:
LED-displays

LED	Status	Meaning	Remedy
IOs	Off	CPU not supplied.	– Check the voltage supply U_{SYS} at the gateway.
	Green	The configured module bus station corresponds to the physically connected station, communication is active.	–
	Green flashing 1 Hz	Station is in the I/O-ASSISTANT Force Mode.	– Deactivate the I/O-ASSISTANT Force Mode.
	Red	CPU is not ready, V_{CC} level is not within the required range → possible reasons: – too many modules connected to the gateway – short circuit in connected module – hardware error in gateway	– Check wiring at the gateway and the voltage supply. – Dismount modules – Replace the gateway.
	Red flashing, 1 Hz	Non-adaptable modification of the physically connected station.	– Compare the planned XI/ON station with the physical station. – Check the physical XI/ON station for defective or incorrectly fitted electronics modules.
	Red flashing, 4 Hz	No module bus communication	– At least one electronics module has to be mounted correctly and has to be able to communicate with the gateway.
	Red/green flashing, 1 Hz	Adaptable modification of the actual layout of the module bus participants; data transfer possible	– Check the XI/ON station for missing or new, unplanned modules.
MS	Off	XI/ON station not supplied.	– Check the voltage supply at the gateway.
	Green	Displays the logical connection to a Master (1. Modbus TCP- connection)	–
	Green flashing	Gateway is ready for operation	–
	Red	Gateway indicates error	–
	Red flashing	DHCP/BootP search of settings, wait for address setting	–

Table 7:
LED-displays

LED	Status	Meaning	Remedy
ETH1, ETH2	Off	No Ethernet link	– Check the Ethernet-connection.
	Green	Link with 10/100 Mbps	–
	Green flashing	Ethernet Traffic	–
	Yellow	100 Mbps (if no LED lits yellow: 10 Mbps)	–

4 Technical Features

4.7 Status indicators/diagnostic messages gateway

5 Implementation of Modbus TCP

5.1 Common Modbus description

5.1.1 Protocol description

The Modbus protocol defines a simple protocol data unit (PDU) independent of the underlying communication layers.

The mapping of Modbus protocol on specific buses or networks can introduce some additional fields on the application data unit (ADU).

Figure 33:
Modbus telegram acc. to Modbus-IDA

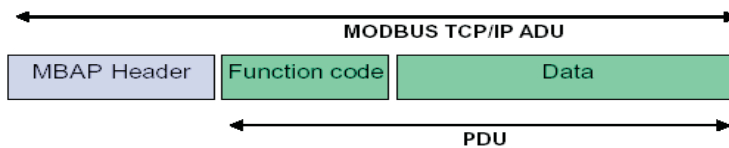

The Modbus application data unit is built by the client that initiates a Modbus transaction.

The function code indicates to the server what kind of action to perform. The Modbus application protocol establishes the format of a request initiated by a client.

The function code field of a Modbus data unit is coded in one byte. Valid codes are in the range of 1...255 decimal (128...255 reserved for exception responses).

When a message is sent from a Client to a Server device the function code field tells the server what kind of action to perform. Function code "0" is not valid.

Sub-function codes are added to some function codes to define multiple actions.

The data field of messages sent from a client to server devices contains additional information that the server uses to take the action defined by the function code. This can include items like discrete and register addresses, the quantity of items to be handled, and the count of actual data bytes in the field.

The data field may be nonexistent (of zero length) in certain kinds of requests, in this case the server does not require any additional information. The function code alone specifies the action.

If no error occurs related to the Modbus function requested in a properly received Modbus ADU the data field of a response from a server to a client contains the data requested.

Figure 34:
Modbus data transmission (acc. to Modbus-IDA)

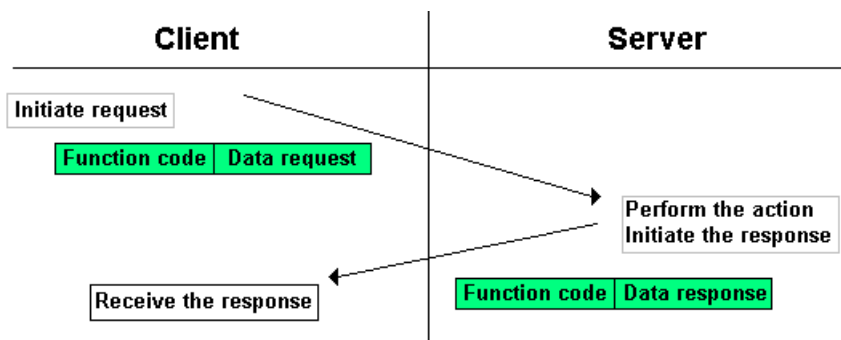

If an error related to the Modbus function requested occurs, the field contains an exception code that the server application can use to determine the next action to be taken.

Figure 35:
Modbus data
transmission
(acc. to Mod-
bus-IDA)

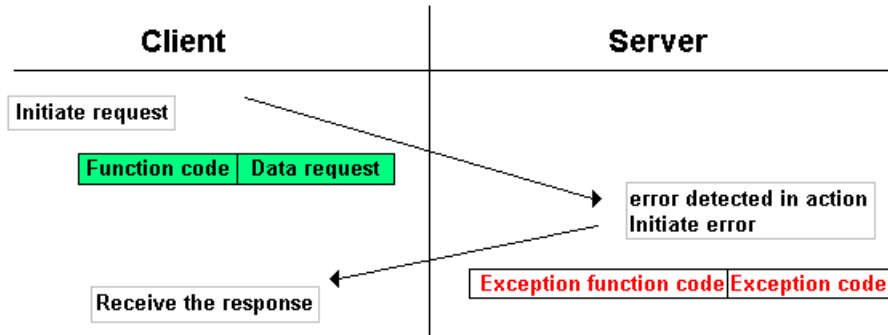

5.1.2 Data model

The data model distinguishes 4 basic data types:

Table 8:
Data types for
Modbus

Data type	Object type	Access	Comment
Discrete Inputs	Bit	Read	This type of data can be provided by an I/O system.
Coils	Bit	Read-Write	This type of data can be alterable by an application program.
Input Registers	16-Bit, (Word)	Read	This type of data can be provided by an I/O system.
Holding Registers	16-Bit, (Word)	Read-Write	This type of data can be alterable by an application program.

For each of these basic data types, the protocol allows individual selection of 65536 data items, and the operations of read or write of those items are designed to span multiple consecutive data items up to a data size limit which is dependent on the transaction function code.

It's obvious that all the data handled via Modbus (bits, registers) must be located in device application memory.

Access to these data is done via defined access-addresses (see Chapter 5.3 Modbus registers, Page 54).

The example below shows the data structure in a device with digital and analog in- and outputs.

5 Implementation of Modbus TCP

5.1 Common Modbus description

XI/ON devices have only one data block, whose data can be accessed via different Modbus functions. The access can be carried out either via registers (16-bit-access) or, for some of them, via single-bit-access.

Figure 36:
Picture of the
data memory of
the XI/ON gate-
ways

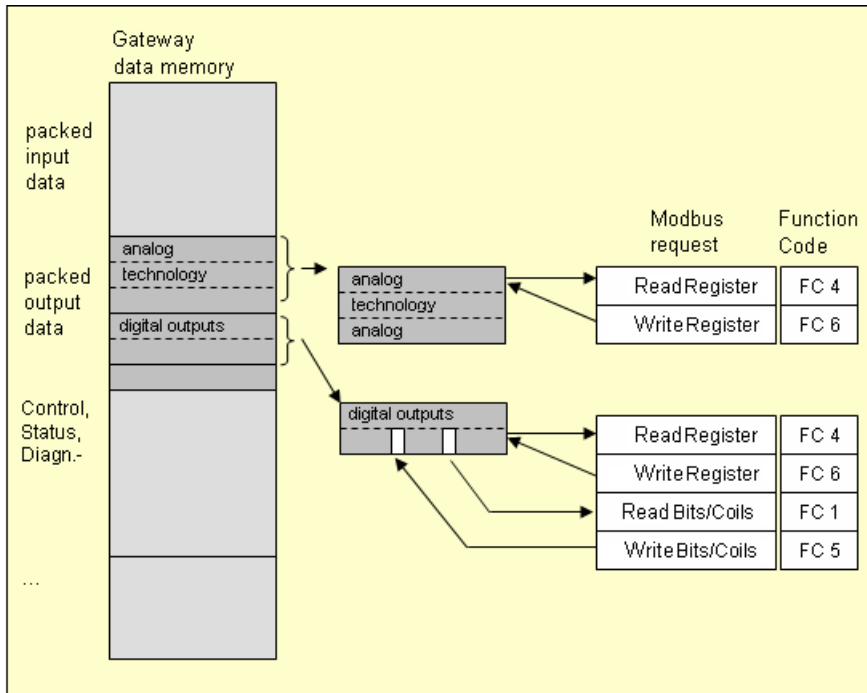

5.2 Implemented Modbus functions

The XI/ON gateway for Modbus TCP supports the following functions for accessing process data, parameters, diagnostics and other services.

Table 9:
Implemented
functions

Function Codes	
No.	Function Description
1	Read Coils Serves for reading multiple output bits.
2	Read Discrete Inputs Serves for reading multiple input bits
3	Read Holding Registers Serves for reading multiple output registers
4	Read Input Registers Serves for reading multiple input registers
5	Write Single Coil Serves for writing single output bits
6	Write Single Register Serves for writing single output registers
15	Write Multiple Coils Serves for writing multiple output bits
16	Write Multiple Registers Serves for writing multiple output registers
23	Read/Write Multiple Registers Serves for reading and writing multiple registers

5 Implementation of Modbus TCP

5.3 Modbus registers

5.3 Modbus registers



Note

The Table 11:, Mapping of XNE-GWBR-2ETH-MB Modbus registers (holding registers), Page 56 shows the register mapping for the different Modbus addressing methods.

Table 10:

Modbus registers of the gateway

A ro = read only
rw = read/write

Address (hex.)	Access A	Description
0x0000 to 0x01FF	ro	packed process data of inputs (process data length of modules, see Table 12: Data width of the I/O-modules, Page 61)
0x0800 to 0x09FF	rw	packed process data of outputs (process data length of modules, see Table 12: Data width of the I/O-modules, Page 61)
0x1000 to 0x1006	ro	gateway identifier
0x100C	ro	gateway status (see Table 13: Register 100Ch: gateway-status, Page 63)
0x1010	ro	process image length in bit for the intelligent output modules
0x1011	ro	process image length in bit for the intelligent input modules
0x1012	ro	process image length in bit for the digital output modules
0x1013	ro	process image length in bit for the digital input modules
0x1017	ro	register-mapping revision (always 1, if not, mapping is incompatible with this description)
0x1018 to 0x101A	ro	group diagnostics of I/O-modules 0 to 32 (1 bit per I/O-module)
0x1020	ro	watchdog, actual time [ms]
0x1120	rw	watchdog predefined time [ms] (default: 0)
0x1121	rw	watchdog reset register
0x1130	rw	modbus connection mode register
0x1131	rw	modbus connection time-out in seconds (default: 0 = never)
0x113C to 0x113D	rw	modbus parameter restore
0x113E to 0x113F	rw	modbus parameter save

Table 10:
Modbus
registers of the
gateway

Address (hex.)	Access A	Description
0x2000 to 0x207F	rw	service-object, request-area
0x2080 to 0x20FF	ro	service-object, response-area
0x2400	ro	system voltage U_{SYS} [mV]
0x2401	ro	load voltage U_L [mV]
0x2405	ro	load current I_L [A]
0x27FE	ro	no. of entries in actual module list
0x27FF	rw	no. of entries in reference module list
0x2800 to 0x2840	rw	reference module list (74 × 4 bytes per module-ID)
0x2900 to 0x29A0	ro	reserved
0x2A00 to 0x2A20	ro	actual module list (74 × 4 bytes per module-ID)
0x4000 to 0x47FF	-	reserved
0x8000 to 0x8FFF	ro	process data inputs (128 × 64 Byte, but: maximum module number for XI/ON = 32 modules per station)
0x9000 to 0x9FFF	rw	process data outputs (128 × 64 Byte, but: maximum module number for XI/ON = 32 modules per station)
0xA000 to 0xAFFF	ro	diagnostics (128 × 64 Byte, but: maximum module number for XI/ON = 32 modules per station)
0xB000 to 0xBFFF	rw	parameters (128 × 64 Byte, but: maximum module number for XI/ON = 32 modules per station)

5 Implementation of Modbus TCP

5.3 Modbus registers

The following table shows the register mapping for the different Modbus addressing methods:

Table 11: Mapping of XNE-GWBR- 2ETH-MB Modbus regis- ters (holding registers)	Description	Hex	Decimal	5-Digit	Modicon
	packed process data of inputs	0x0000 to 0x01FF	0 to 511	40001 to 40512	400001 to 400512
	packed process data of outputs	0x0800 to 0x09FF	2048 to 2549	42049 to 42560	402049 to 402560
	gateway identifier	0x1000 to 0x1006	4096 to 4102	44097 to 44103	404097 to 404103
	gateway status	0x100C	4108	44109	404109
	process image length in bit for the intel- ligent output modules	0x1010	4112	44113	404113
	process image length in bit for the intel- ligent input modules	0x1011	4113	44114	404114
	process image length in bit for the digital output modules	0x1012	4114	44115	404115
	process image length in bit for the digital input modules	0x1013	4115	44116	404116
	register-mapping revision	0x1017	4119	44120	404120
	group diagnostics of I/O-modules 0 to 32 (1 bit per I/O-module)	0x1018 to 0x101A	4120 to 4122	44121 to 44123	404121 to 404123
	watchdog, actual time	0x1020	4128	44129	404129
	watchdog predefined time [ms]	0x1120	4384	44385	404385
	watchdog reset register	0x1121	4385	44386	404386
	modbus connection mode register	0x1130	4400	44401	404401
	modbus connection time-out in sec.	0x1131	4401	44402	404402
	modbus parameter restore	0x113C to 0x113D	4412 to 4413	44413 to 44414	404413 to 404414
	modbus parameter save	0x113E to 0x113F	4414 to 4415	44415 to 44416	404415 to 404416
	service-object, request-area	0x2000 to 0x207F	8192 to 8319	48193 to 48320	408193 to 408320
	service-object, response-area	0x2080 to 0x20FF	8320 to 8447	48321 to 48448	408321 to 408448
	system voltage U_{SYS} [mV]	0x2400	9216	49217	409217
	load voltage U_L [mV]	0x2401	9217	49218	409218
	load current I_L [A]	0x2405	9221	49222	409222

5 Implementation of Modbus TCP

5.3 Modbus registers

Description	Hex	Decimal	5-Digit	Modicon
no. of entries in actual module list	0x27FE	10238	-	410239
no. of entries in reference module list	0x27FF	10239	-	410240
reference module list (32 × 4 bytes per module-ID)	0x2800 to 0x2840	10240 to 10304	-	410241 to 410305
reserved	0x2900 to 0x29A0	-	-	-
actual module list (32 × 4 bytes per module-ID)	0x2A00 to 0x2A20	10752 to 10784	-	410753 to 410785
reserved	0x4000 to 0x47FF	-	-	-
Slot-related addressing				
process data inputs (32 × 64 bytes)	0x8000 to 0x8400			
Slot 1	0x8000	32768	-	432769
Slot 2	0x8020	32800	-	432801
Slot 3	0x8040	32832	-	432833
...				
Slot 32	0x83E0	33760		433761
process data outputs (32 × 64 bytes)	0x9000 to 0x9400			
Slot 1	0x9000	32768	-	432769
Slot 2	0x9020	32800	-	432801
Slot 3	0x9040	32832	-	432833
...				
Slot 32	0x93E0	33760		433761
diagnostics (32 × 64 bytes)	0xA000 to 0xA400			
Slot 1	0xA000	40960	-	440961
Slot 2	0xA020	40992	-	440993
Slot 3	0xA040	41034	-	441035
...				
Slot 32	0xA3E0	41952		441953

5 Implementation of Modbus TCP

5.3 Modbus registers

Description	Hex	Decimal	5-Digit	Modicon
parameters (32 × 64 bytes)	0xB000 to 0xB400			
Slot 1	0xB000	45056	-	445057
Slot 2	0xB020	45088	-	445089
Slot 3	0xB040	45120	-	445121
...				
Slot 32	0xB3E0	46048		446049

5.4 Structure of the packed in-/ output process data

In order to assure a largely efficient access to the process data of a station, the module data are consistently packed and mapped to a coherent register area.

The I/O-modules are divided into digital and intelligent modules (analog modules, serial interfaces, counters...).



Note

Relating to the data mapping, the XNE-1SWIRE modules do not belong to the intelligent modules. Theirs process data are mapped in the range of the digital input and output modules.

Both module types are mapped in separate register ranges.

The data mapping always starts with the mapping of the intelligent modules. Each module occupies as many Modbus registers as necessary, depending on it's data width. At least one register is occupied. A RS232-module, for example, occupies 4 consecutive registers (8 bytes) in the input and in the output area.

The data byte arrangement is done according to the physical order in the station, from the left to the right.

The data of the intelligent modules are followed by the data of the digital modules, also structured according to their physical appearance in the station. The Modbus registers for the digital data are filled up to 16 bit. This means on the one hand that one Modbus register can contain data of different digital modules and on the other hand that the data of one digital module can be distributed over multiple registers. Bit 0 of a digital module is thus not necessarily located on a word limit.



Note

An example in Chapter 6.3 Communication examples: Modbus TCP, Page 116. describes the data mapping. Additionally, the software I/O-ASSISTANT offers the possibility to create a mapping table for every station.

5 Implementation of Modbus TCP

5.4 Structure of the packed in-/ output process data

5.4.1 Packed input-process data

- input register area: **0000h** to **01FFh**

0000h			01FFh
intelligent modules, input data	digital input modules	status/ diagnosis	free



Note

Independent of the I/O-configuration, an access to all 512 registers is always possible. Registers that are not used send "0".

Status/ diagnosis

The area "status/diagnosis" comprises a maximum of 9 registers.

The first register contains a common gateway-/station-status.

The following registers (max. 8) contain a group diagnostic bit for each I/O-module which shows whether a diagnostic message is pending for the relevant module or not.

Status/ diagnostic	
n + 0000h	n + 0008h
gateway status (Reg. 100Ch)	group diagnosis I/O-modules 0...127 (registers 1018h to 101Fh)

5.4.2 Packed output process data

- output register area: **0800h** to **09FFh**

0800h		09FFh
intelligent modules, output data	digital output data	free



Note

Independent of the I/O-configuration, an access to all 512 registers is always possible. Registers that are not used send "0" answering a read access, write accesses are ignored.

5.5 Data width of the I/O-modules in the modbus-register area

The following table shows the data width of the XI/ON I/O-modules within the modbus register area and the type of data alignment.

Table 12:
Data width of
the I/O-modules

Module	Process input	Process output	Alignment
digital inputs			
XN-2DI-...	2 bit	-	bit by bit
XN-4DI-...	4 bit	-	bit by bit
XN-16DI-...	16 bit	-	bit by bit
XN-32DI-...	32 bit	-	bit by bit
XNE-8DI-...	8 bit	-	bit by bit
XNE-16DI-...	16 bit	-	bit by bit
digital outputs			
XN-2DO-...	-	2 bit	bit by bit
XN-4DO-...	-	4 bit	bit by bit
XN-16DO-...	-	16 bit	bit by bit
XN-32DO-...	-	32 bit	bit by bit
XNE-8DO-...	-	8 bit	bit by bit
XNE-16DO-...	-	16 bit	bit by bit
analog inputs			
XN-1AI-...	1 word		word by word
XN-2AI-...	2 words		word by word
XN-4AI-...	4 words		word by word
XNE-8AI-U/I-4PT/NI	8 words		word by word
analog outputs			
XN-1AO-...		1 word	word by word
XN-2AO-...		2 words	word by word
XNE-4AO-U/I		4 words	word by word
technology modules			
XN-1CNT-24VDC	4 words	4 words	word by word
XNE-2CNT-2PWM	12 words	12 words	word by word
XN-1RS...	4 words	4 words	word by word

5 Implementation of Modbus TCP

5.5 Data width of the I/O-modules in the modbus-register area

Table 12: Data width of the I/O-modules	Module	Process input	Process output	Alignment
A The process data of the XNE-1SWIRE-modules are mapped into the registers for the digital in- and output modules	XN-1SSI	4 words	4 words	word by word
	XNE-1SWIRE A	4 words	4 words	word by word
	power supply modules			
	XN-BR-...	-		
	XN-PF-...	-		

5.5.1 Register 100Ch: "Gateway-Status"

This register contains a general gateway-/ station-status.

Table 13:
Register 100Ch:
gateway-status

Bit	Name	Description
Gateway		
15	I/O Controller Error	The communication controller for the I/O-system is faulty.
14	Force Mode Active Error	The Force-Mode is activated. The state of the outputs may no longer accord to the settings made via the field bus.
13	reserved	-
12	Modbus Wdog Error	A time-out in the Modbus communication occurred.
Module bus		
11	I/O Cfg Modified Error	The I/O-configuration has been changed and is now incompatible.
10	I/O Communication Lost Error	No communication on the I/O-module bus.
Voltage errors		
9	U_{SYS} too low	System supply voltage too low (< 18 VDC).
8	U_{SYS} too high	System supply voltage too high (> 30 VDC).
7	U_L too low	Load voltage too low (< 18 VDC).
6	U_L too high	Load voltage too high (> 30 V DC).
5	I_{SYS} too high	Overload of the system voltage supply.
4	reserved	-
Warnings		
3	I/O Cfg Modified Warning	The station-configuration has changed.
0	I/O Diags Active Warning	At least one I/O-module sends active diagnostics.

5 Implementation of Modbus TCP

5.5 Data width of the I/O-modules in the modbus-register area

5.5.2 Register 1130h: "Modbus-connection-mode"

This register defines the behavior of the Modbus connections:

Bit	Name, description
15 to 2	reserved
1	MB_ImmediateWritePermission – 0: With the first write access, a write authorization for the respective Modbus-connection is requested. If this request fails, an exception response with exception-code 01h is generated. If the request is accepted, the write access is executed and the write authorization remains active until the connection is closed. – 1: The write authorization for the respective Modbus-connection is already opened during the establishment of the connection. The first Modbus-connection thus receives the write authorization, all following connections don't (only if bit 0 = 1).
0	MB_OnlyOneWritePermission – 0: all Modbus-connections receive the write authorization – 1: only one Modbus-connection can receive the write permission. A write permission is opened until a Disconnect. After the Disconnect the next connection which requests a write access receives the write authorization.

5.5.3 Register 1131h: "Modbus-connection time-out"

This register defines after which time of inactivity a Modbus-connection is closed through a Disconnect.

5.5.4 Register 0x113C and 0x113D: "Restore Modbus-connection parameter"

Registers 0x113C and 0x113D serve for resetting the parameter-register 0x1120 and 0x1130 to 0x113B to the default settings.

For this purpose, write "0x6C6F" in register 0x113C. To activate the reset of the registers, write "0x6164" ("load") within 30 seconds in register 0x113D.

Both registers can also be written with one single request using the function codes FC16 and FC23.

The service resets the parameters without saving them. This can be achieved by using a following "save" service.

5.5.5 Register 0x113E and 0x113F: "Save Modbus-connection parameters"

Registers 0x113E and 0x113F are used for the non-volatile saving of parameters in registers 0x1120 and 0x1130 to 0x113B.

For this purpose, write "0x7361" in register 0x113E. To activate the saving of the registers, write "0x7665" ("save") within 30 seconds in register 0x113F.

Both registers can also be written with one single request using the function codes FC16 and FC23.

5.6 The Service-Object

The service-object is used to execute one-time or acyclic services. It is an acknowledge service which may serve, for example, to parameterize an I/O-module.

2000h	2080h	20FFh
service request area	service response area	

The service request area allows write access, the service response area only read access.

- Service request area

2000h	2001h	2002h	2003h	2004h	2005h	207Fh
service no.	reserved	service code	index/ addr	data-reg-count	optional data (0 to 122 registers)	

The register **service no.** in the request area can contain a user defined value which is deleted after the execution of the service.

The register **service code** specifies which service is requested.

The register **index/addr** is optional and the meaning depends on the particular service.

The register **data-reg-count** contains, depending on the service, the number (0 to 122) of the transferred or of the requested data registers.

Depending on the service, the **optional data** area can contain additional parameters and/or other data to be written.

- Service response area

2080h	2081h	2082h	2083h	2084h	2085h	20FFh
service no.	result	service code	index/ addr	data-reg-count	optional data (0 to 122 registers)	

After the execution of a request, the registers **service-no.**, **service code** and **index/addr** in the response area contain a copy of the values in the request area.



Note

The service no. is thus used for a simple handshake on the application level. The application increases the service no. with every request. The service is blocked, until the service number in the request area matches the service number in the response area.

The register **result** shows whether the execution was successful or not.

The register **data-reg-count** contains the number of data registers (0 to 122).

The **optional Data** area can contain, depending on the service, the requested data.

5 Implementation of Modbus TCP

5.6 The Service-Object

Supported service numbers:

Table 15:
Supported
service
numbers:

Service code	Meaning
0x0000	no function
0x0003	indirect reading of registers
0x0010	indirect writing of registers

A service request may have the following results:

Table 16:
results of the
service request

Service code	Meaning
0x0000	error free execution of service
0xFFFE	service parameters incorrect/ inconsistent
0xFFFF	service code unknown



Note

The services "indirect reading of registers" and "indirect writing of registers" offer an additional possibility to access any Modbus register.

Current Modbus-masters support only a limited number of register- areas that can be read or written during the communication with a Modbus-server. These areas can not be changed during operation.

In this case, the services mentioned above enables non-cyclic access to registers.

5.6.1

Indirect reading of registers

1 to 122 (Count) Modbus-registers are read, starting with address x (Addr).

- service-request

2000h	2001h	2002h	2003h	2004h	2005h	207Fh
service no.	0x0000	0x0003	Addr	Count	reserved	

- service-response

2080h	2081h	2082h	2083h	2084h	2085h	20FFh
service no.	result	0x0003	Addr	Count	register contents	

5.6.2 "Indirect writing of registers"

1 to 122 (Count) Modbus-registers are written, starting with address x (Addr).

- service-request

2000h	2001h	2002h	2003h	2004h	2005h	207Fh
service no.	0x0000	0x0010	Addr	Count	register contents	

- service-response

2080h	2081h	2082h	2083h	2084h	2085h	20FFh
service no.	result	0x0010	Addr	Count	reserved	

5 Implementation of Modbus TCP

5.7 Bit areas: mapping of input-discrete- and coil-areas

5.7 Bit areas: mapping of input-discrete- and coil-areas

The digital in- and outputs can be read and written (for outputs) as registers in the data area of the packed in- and output process data.



Note

In the packed process data, the digital I/O data are stored following the variable in- and output data area of the intelligent modules, which means they are stored with a variable offset, depending on the station's I/O-configuration.

In order to set for example a single output (single coil), the following functions are available for reading and writing single bits:

- FC1 ("Read Coils"),
- FC2 ("Read Discrete Inputs"),
- FC 5 ("Write Single Coil")
- FC15 ("Write Multiple Coils")

Data mapping in the input-discrete- and coil-areas:

- Mapping: input-discrete-area
All digital inputs are stored in this area (offset "0").
- Mapping: Coil-area
All digital outputs are stored in this area (offset "0").

5.8 Error behavior of outputs

In case of a failure of the Modbus communication, the outputs' behavior is as follows, depending on the defined time for the Watchdog (register 0x1120, page 54):

- Watchdog = 0 ms (default setting)
→ outputs hold the momentary value
- Watchdog > 0 ms
→ outputs switch to "0" after the watchdog time has expired



Note

Setting the outputs to predefined substitute values is not possible in Modbus TCP. Eventually parameterized substitute values will not be used.

5.9 Parameters of the modules

5.9.1 Analog input modules

- XN-1AI-I(0/4...20mA)

Table 17: Module parameters	Byte	Bit	Parameter name	Value
A Default- settings	0	0	Current mode	0 = 0..20mA A 1 = 4..20mA
		1	Value representation	0 = Integer (15bit + sign) A 1 = 12bit (left-justified)
		2	Diagnostics	0 = release A 1 = block

- XN-2AI-I(0/4...20mA) (1 byte parameter per channel)

Table 18: Module parameters	Byte	Bit	Parameter name	Value
A Default- settings	0/1	0	Current mode	0 = 0..20mA A 1 = 4..20mA
		1	Value representation	0 = Integer (15bit + sign) A 1 = 12bit (left-justified)
		2	Diagnostics	0 = release A 1 = block
		3	Channel Kx	0 = activate A 1 = deactivate

- XN-1AI-U(-10/0...+10VDC)

Table 19: Module parameters	Byte	Bit	Parameter name	Value
A Default- settings	0	0	Voltage mode	0 = 0..10V A 1 = -10..+10V
		1	Value representation	0 = Integer (15bit + sign) A 1 = 12bit (left-justified)
		2	Diagnostics	0 = release A 1 = block

5 Implementation of Modbus TCP

5.9 Parameters of the modules

- XN-2AI-U(-10/0...10VDC) (1 byte parameter per channel)

Table 20: Module parameters	Byte	Bit	Parameter name	Value
	0/1	0	Voltage mode	0 = 0..10V A 1 = -10..+10V
A Default- settings		1	Value representation	0 = Integer (15bit + sign) A 1 = 12bit (left-justified)
		2	Diagnostics	0 = release A 1 = block
		3	Channel Kx	0 = activate A 1 = deactivate

- XN-2AI-PT/NI-2/3 (2 byte parameter per channel)

Table 21: Module parameters	Byte	Bit	Parameter name	Value
	0/2	0	Mains suppression Kx	0 = 50Hz A 0 = 60Hz
A Default- settings		1	Value representation Kx	0 = Integer (15bit + sign) A 1 = 12bit (left-justified)
		2	Diagnostics Kx	0 = release A 1 = block
		3	Channel Kx	0 = activate A 1 = deactivate
		7 to 4	Element Kx	0000 = PT100, -200..850°C A 0001 = PT100, -200..150°C 0010 = NI100, -60..250°C 0011 = NI100, -60..150°C 0100 = PT200, -200..850°C 0101 = PT200, -200..150°C 0110 = PT500, -200..850°C 0111 = PT500, -200..150°C 1000 = PT1000, -200..850°C 1001 = PT1000, -200..150°C 1010 = NI1000, -60..250°C 1011 = NI1000, -60..150°C 1100 = resistance, 0..100 Ohm 1101 = resistance, 0..200 Ohm 1110 = resistance, 0..400 Ohm 1111 = resistance, 0..1000 Ohm
	1/3	0	Measurement mode Kx	0 = 2-wire A 1 = 3-wire

- XN-2AI-THERMO-PI (2 byte parameter per channel)

Table 22: Module parameters	Byte	Bit	Parameter name	Value
	0/1	0	Mains suppression Kx	0 = 50Hz A 0 = 60Hz
A Default- settings		1	Value representation Kx	0 = Integer (15bit + sign) A 1 = 12bit (left-justified)
		2	Diagnostics Kx	0 = release A 1 = block
		3	Channel Kx	0 = activate A 1 = deactivate
	7 to 4		Element Kx	0000 = type K, -270..1370°C A 0001 = type B, +100..1820°C 0010 = type E, -270..1000°C 0011 = type J, -210..1200°C 0100 = type N, -270..1300°C 0101 = type R, -50..1760°C 0110 = type S, -50..1540°C 0111 = type T, -270..400°C 1000 = +/-50 mV 1001 = +/-100 mV 1010 = +/-500 mV 1011 = +/-1000 mV ... = reserved

- XN-4AI-U/I (1 byte parameter per channel)

Table 23: Module parameters	Byte	Bit	Parameter name	Value
	0 to 3	0	Range	0 = 0..10V/ 0..20mA A 1 = -10..+10V/ 4..20mA
A Default- settings		1	Value representation	0 = Integer (15bit + sign) A 1 = 12bit (left-justified)
		2	Diagnostics	0 = release A 1 = block
		3	Channel Kx	0 = activate A 1 = deactivate
		4	Operation mode	0 = voltage A 1 = current

5 Implementation of Modbus TCP

5.9 Parameters of the modules

- XNE-8AI-U/I-4PT/NI (1 byte per channel)

Table 24:
Module
parameters

	Byte	Bit	Parameter name	Value	Meaning
A Default-settings B In PT-, NI- and resistance measurement, only the first of the used channel has to be parameterized (channel 1, 3, 5, 7). The parameterization of the second channel is ignored.	0 to 7	0 to 5	Operation mode Kx	000000	voltage -10V..10V standard A
				000001	voltage 0..10V standard
				000010	voltage -10V..10V NE43
				000011	voltage 0..10V NE43
				000100	voltage -10V..10V ext. range
				000101	voltage 0..10V ext. range
				000110	reserved
				000111	reserved
				001000	current 0..20mA standard
				001001	current 4..20mA standard
				001010	current 0..20mA NE43
				001011	current 4..20mA NE43
				001100	current 0..20mA ext. range
				001101	current 4..20mA ext. range
				001110	reserved
				001111	reserved
				010000	PT100, -200..850°C 2-wire B
				010001	PT100, -200..150°C 2-wire B
				010010	PT200, -200..850°C 2-wire B
				010011	PT200, -200..150°C 2-wire B
				010100	PT500, -200..850°C 2-wire B
				010101	PT500, -200..150°C 2-wire B
				010110	PT1000, -200..850°C 2-wire B
				010111	PT1000, -200..150°C 2-wire B
				011000	PT100, -200..850°C 3-wire B
				011001	PT100, -200..150°C 3-wire B
				011010	PT200, -200..850°C 3-wire B
				011011	PT200, -200..150°C 3-wire B
				011100	PT500, -200..850°C 3-wire B
				011101	PT500, -200..150°C 3-wire B
				011110	PT1000, -200..850°C 3-wire B
				011111	PT1000, -200..150°C 3-wire B
				100000	NI100, -60..250°C 2-wire B
				100001	NI100, -60..150°C 2-wire B
				100010	NI1000, -60..250°C 2-wire B
				100011	NI1000, -60..150°C 2-wire B
				100100	NI1000TK5000, -60..250°C 2-wire B
				100101	reserved
				100110	reserved
				100111	reserved
				101000	NI100, -60..250°C 3-wire B
				101001	NI100, -60..150°C 3-wire B
				101010	NI1000, -60..250°C 3-wire B
				101011	NI1000, -60..150°C 3-wire B
				101100	NI1000TK5000, -60..250°C 3-wire B
				101101	reserved
				101110	reserved
101111	reserved				

Table 24:
Module
parameters

Byte	Bit	Parameter name	Value	Meaning
0 to 7	0 to 5	Operation mode Kx	110000	resistance, 0..250 Ohm B
			110001	resistance, 0..400 Ohm B
			110010	resistance, 0..800 Ohm B
			110011	resistance, 0..2000 Ohm B
			110100	resistance, 0..4000 Ohm B
			110101 to 111110	reserved
			111111	deactivate
			6	
1	12bit (left-justified)			
7		Diagnostics Kx	0	release A
			1	block

5 Implementation of Modbus TCP

5.9 Parameters of the modules

5.9.2 Analog output modules

- XN-1AO-I(0/4...20mA)

Table 25: Module parameters	Byte	Bit	Parameter name	Value
A Default- settings	0	0	Current mode	0 = 0..20mA A 1 = 4..20mA
		1	Value representation	0 = Integer (15bit + sign) A 1 = 12bit (left-justified)
	2 to 7		reserved	
	1		Substitute value low byte	In Modbus TCP, the output of a substitute value in case of an error is not possible, page 68.
	2		Substitute value high byte	

- XN-2AO-I(0/4...20mA) (3 Byte per channel)

Table 26: Module parameters	Byte	Bit	Parameter name	Value
A Default- settings	0/3	0	Current mode	0 = 0..20mA A 1 = 4..20mA
		1	Value representation	0 = Integer (15bit + sign) A 1 = 12bit (left-justified)
	2	reserved		
	3		Channel Kx	0 = activate A 1 = deactivate
	4 to 7		reserved	
	1/4		Substitute value low byte	In Modbus TCP, the output of a substitute value in case of an error is not possible, page 68.
	2/5		Substitute value high byte	

- XN-2AO-U(-10/0...+10VDC) (3 byte per channel)

Byte	Bit	Parameter name	Value
0/3	0	Voltage mode	0 = 0..10V A 1 = -10..+10V
	1	Value representation	0 = Integer (15bit + sign) A 1 = 12bit (left-justified)
	2	reserved	
	3	Channel Kx	0 = activate A 1 = deactivate
	4 to 7	reserved	
1/4		Substitute value low byte	In Modbus TCP, the output of a substitute value in case of an error is not possible, page 68.
2/5		Substitute value high byte	

5 Implementation of Modbus TCP

5.9 Parameters of the modules

- XNE-4AO-U/I (3 byte per channel)

Table 28: Module parameters	Byte	Bit	Parameter name	Value	Meaning
A Default- settings	0/3/6/9	0 to 3	Operation mode Kx	0000	voltage -10V..10V standard A
				0001	voltage 0..10V standard
				0010	voltage -10V..10V NE43
				0011	voltage 0..10V NE43
				0100	voltage -10V..10V ext. range
				0101	voltage 0..10V ext. range
				0110	reserved
				0111	reserved
				1000	current 0..20mA standard
				1001	current 4..20mA standard
				1010	current 0..20mA NE43
				1011	current 4..20mA NE43
				1100	current 0..20mA ext. range
				1101	current 4..20mA ext. range
				1110	reserved
1111	deactivate				
4		Value repre- sentation Kx	0	Integer (15bit + sign) A	
			1	12bit (left-justified)	
5		Diagnostics Kx	0	release A	
			1	block	
6 to 7		Behaviour module bus error Ax	00	output substitute value A	
			01	hold current value	
			10	reserved	
			11	reserved	
1/4/7/10		Substitute value Ax LOW-byte		In Modbus TCP, the output of a substitute value in case of an error is not possible, page 68.	
2/5/8/11		Substitute value Ax HIGH-byte			

5.9.3 Technology modules

- XN-1CNT-24VDC, Counter mode

Table 29:
Module
parameters

A Default-
settings

Byte	Bit	Parameter name	Value
0	0 to 5	Counter mode	000000 = continuous count A 000001 = single-action count 000010 = periodical count
1	0	Gate function	0 = abort count procedure A 1 = interrupt count procedure
	1	Digital input DI	0 = normal A 1 = inverted
	2/3	Function DI	00 = input A 01 = HW-gate 10 = Latch-retrigger when edge positive 11 = Synchronization when edge positive
	4	Synchronization	0 = single-action A 1 = periodical
2 to 5		Lower count limit	-2 147 483 648 (-2^{31}) to 0
		Lower count limit (HWORD)	-32768 A to 0 (Signed16)
		Lower count limit (LWORD)	-32 768 to 32 767 (Signed16); 0 A
6 to 9		Upper count limit	0 to + 2 147 483 647 ($2^{31}-1$)
		Upper count limit (HWORD)	0 to 32767 A (Unsigned16)
		Upper count limit (LWORD)	0 to 65535 A (Unsigned16)
10		Hysteresis	0 A to 255 (Unsigned8)
11		Pulse duration DO1, DO2 [n*2ms]	0 A to 255 (Unsigned8)

5 Implementation of Modbus TCP

5.9 Parameters of the modules

Table 29:
Module
parameters

Byte	Bit	Parameter name	Value
12	0	Substitute value DO	0 A 1
	1	Diagnostic DO1	0 = on A 1 = off
	2/ 3	Function DO1	00 = output A 01 = on when cnt value \geq ref. value 10 = on when cnt value \leq ref. value 11 = pulse when cnt val. = ref. value
	5/ 6	Function DO2	00 = output A 01 = on when cnt value \geq ref. value 10 = on when cnt value \leq ref. value 11 = pulse when cnt val. = ref. value
13	0/ 1	Signal evaluation (A,B)	00 = pulse and direction A 01 = rotary sensor: single 10 = rotary sensor: double 11 = rotary sensor: fourfold
	2	Sensor/ input filter (A)	0 = 2.5 μ s (200 kHz) A 1 = 25 μ s (20 kHz)
	3	Sensor/ input filter (B)	0 = 2.5 μ s (200 kHz) A 1 = 25 μ s (20 kHz)
	4	Sensor/ input filter (DI)	0 = 2.5 μ s (200 kHz) A 1 = 25 μ s (20 kHz)
	5	Sensor (A)	0 = normal A 1 = inverted
	7	Direction input (B)	0 = normal A 1 = inverted
14	0	Group diagnostics	0 = release A 1 = block
	4/ 5	Behavior CPU/master STOP	- 00 = switch off DO1 A - 01 = proceed with operating mode - 10 = DO1 switch to substitute value - 11 = DO1 hold last value

- XN-1CNT-24VDC, measurement mode

Table 30:
Module
parameters**A** Default-
settings

Byte	Bit	Parameter name	Value
0	0 to 5	Measurement mode	100000 = frequency measurement 100001 = revolutions measurement 100010 = period duration measurement
1	0	Digital input DI	0 = normal A 1 = inverted
	1	Function DI	0 = input A5 1 = HW gate
2 to 4		Lower limit	0 to 16 777 214 x 10 ⁻³
		Lower limit (HWORD)	0 A to 255 (Unsigned8)
		Lower limit (LWORD)	0 A to 65535
5 to 7		Upper limit	1 to 16 777 215 x 10 ⁻³
		Upper limit (HWORD)	0 A to 255 (Unsigned8)
		Upper limit (LWORD)	0 A to 65535
8 to 9		Integration time [n*10ms]	1 to 1 000; 10 A
10 to 11		Sensor pulse per revolution	1 A to 65535
12	0	Substitute value DO1	0 A 1
	1	Diagnostic DO1	0 = on A 1 = off
12	2/3	Function DO1	00 = output A 01 = outside of limit 10 = below lower limit 11 = above upper limit

5 Implementation of Modbus TCP

5.9 Parameters of the modules

Table 30:
Module
parameters

Byte	Bit	Parameter name	Value
13	0/ 1	Signal evaluation (A,B)	00 = pulse and direction A 01 = rotary sensor: single
	2	Sensor/input filter (A)	0 = 2.5 μ s (200 kHz) A 1 = 25 μ s (20 kHz)
	3	Sensor/ input filter (B)	0 = 2.5 μ s (200 kHz) A 1 = 25 μ s (20 kHz)
	4	Sensor/ input filter (DI)	0 = 2.5 μ s (200 kHz) A 1 = 25 μ s (20 kHz)
	5	Sensor (A)	0 = normal A 1 = inverted
	7	Direction input (B)	0 = normal A 1 = inverted
	14	0	Group diagnostics
4/ 5		Behaviour CPU/master STOP	00 = turn off DO1 A 10 = proceed with operating mode 01 = DO1 switch to substitute value 11 = DO1 hold last value

5 Implementation of Modbus TCP

5.9 Parameters of the modules

- XNE-2CNT-2PWM

Byte	Bit 7	Bit 6	Bit 5	Bit 4	Bit 3	Bit 2	Bit 1	Bit 0
0	input A1	input B1	input Z1	reserved	diagnostic CNT1	measurement mode CNT1	main count direction CNT1	
1	filter Z1		filter A1, B1		reserved	pull up Z1	reserved	threshold input A,B,Z CNT1
2	mode Z1				mode CNT1			
3	input A2	input B2	input Z2	reserved	diagnostic	measurement mode CNT2	main count direction CNT2	
4	filter Z2		filter A2, B2		reserved	pull up Z2	reserved	threshold input A,B,Z CNT2
5	mode Z2				mode CNT2			
6	diagnostic PWM1	reserved	mode D1					
7	DBP1 STS MODE		substitute value P1	substitute value D1	mode PWM1			
8	diagnostic PWM2	reserved	mode D2					
9	DBP2 STS MODE		substitute value P2	substitute value D2	mode PWM2			
10	reserved	ADR AUX REG1 RD DATA						
11	reserved	ADR AUX REG2 RD DATA						
12	reserved	ADR AUX REG2 RD DATA						
13	reserved	ADR AUX REG1 WR DATA						
14	reserved	ADR AUX REG2 WR DATA						
15	reserved	ADR AUX REG3 WR DATA						

5 Implementation of Modbus TCP

5.9 Parameters of the modules

The following table shows the meaning of the parameter bits:

Table 31:
Parameters of
the XNE-2CNT-
2PWM

A Default-
setting

Byte	Parameter name	Value	Meaning	
0,3	Main count direction CNTx	00 A	Basic function	
		01	None	
		10	Up	
		11	Down	
	Measurement mode CNTx	0 A	Frequency measurement	
		1	Period duration measurement	
	Diagnostic CNTx	0 A	Diagnostic messages of the function unit activated in diagnostic interface	
		1	Diagnostic messages of the function unit deactivated in diagnostic interface	
	Input Zx, Input Bx, Input Ax	0 A	Signal logic remains (LOW = 0 / HIGH = 1)	
		1	Invert signal before processing	
	1,4	Threshold input A,B,Z CNTx	0 A	Threshold 7.5V (only valid for Ax, Bx, Zx)
			1	Threshold 2.5V (only valid for Ax, Bx, Zx)
	Pull Up Zx	0 A	Pull Up resistance 20 kΩ off	
		1	Pull Up resistance 20 kΩ on	
	Filter Ax, Bx	00 A	2 μs	
		01	16 μs	
		10	reserved	
		11	reserved	
	Filter Zx	00 A	2 μs	
		01	16 μs	
		10	reserved	
		11	reserved	

Table 31:
Parameters of
the XNE-2CNT-
2PWM

Byte	Parameter name	Value	Meaning	
2,5	Mode CNTx	0000 A	Pulse direction, single sample	
		0001	Pulse direction, double sample	
		0010	AB mode, single sample	
		0011	AB mode, double sample	
		0100	AB mode, four samples	
		0101 to 1110	reserved	
		1111	AB only input	
		Mode Zx (CNTx, PWMx)	0000	Alarm input CNT
			0001 A	HW gate CNT
			0010	Single Latch-Retrigger CNT
			0011	Continuous latch retrigger CNT
			0100	Single L.-R. and HW gate CNT
			0101	Continuous L.-R. and HW gate CNT
			0110	reserved
0111	Alarm input PWM			
1000	HW gate PWM			
1001	Retrigger PWM			
	1010 to 1110	reserved		
	1111	Z just input		
6,8	Mode Dx		Definition of the function for Dx (default = 11 1111 → single output, can be controlled via process data)	
	Diagnostic PWMx	0 A	Diagnostic messages of the function unit activated in diagnostic interface	
		1	Diagnostic messages of the function unit deacti- vated in diagnostic interface	

5 Implementation of Modbus TCP

5.9 Parameters of the modules

Table 31:
Parameters of
the XNE-2CNT-
2PWM

Byte	Parameter name	Value	Meaning
7,9	Mode PWMx	0000 A	PD DC Definition:
		0001	HT LT Definition
		0010 to 0111	reserved
		1111	P just output
		Substitute value Px, Dx	0 A 1
DBPx STS MODE		00 A	STS_DBPx = 1 with (REG_CNTx_CMP0) ≤ (REG_CNTx_CNT) < (REG_CNTx_CMP1)
		01	reserved
		10	
		11	STS_DBPx = Px
10 to 12	ADR AUX REGx WR DATA		Address of the basic write registers (Default ADR AUX REG1 WR DATA = 0x60, ADR AUX REG2 WR DATA = 0x61, ADR AUX REG3 WR DATA = 0x70)
13 to 15	ADR AUX REGx RD DATA		Address of the basic read registers (Default ADR AUX REG1 RD DATA = 0x20, ADR AUX REG2 RD DATA = 0x21, ADR AUX REG3 RD DATA = 0x40)

- XN-1RS232

Table 32:
Module
parameters**A** Default-
settings

Byte	Bit	Parameter name	Value
0	3 to 0	Data rate	0000 = 300 bps 0001 = 600 bps 0010 = 1200 bps 0100 = 2400 bps 0101 = 4800 bps 0110 = 9600 bps A 0111 = 14400 bps 1000 = 19200 bps 1001 = 28800 bps 1010 = 38400 bps 1011 = 57600 bps 1100 = 115200 bps ... reserved
5,4		reserved	-
6		DisableReducedCtrl	Constant setting: – The diagnosis messages are set in Byte 6 of the process input data (independent of "diagnostic"). Byte 6 of the process output data contains two bits which may set to flush the transmit- or the receive-buffer. – Byte 7 contains the status- or the control-byte. – Bytes 0 to 5 contain the user data.
7		Diagnostics	0 = release A – Diagnostics activated: Concerns the field bus specific separate diagnostic message which is not embedded in the process input data. 1 = block

5 Implementation of Modbus TCP

5.9 Parameters of the modules

Table 32:
Module
parameters

Byte	Bit	Parameter name	Value
1	0	Stop bits	0 = 1 bit A 1 = 2 bit
	2,1	Parity	00 = none 01 = odd A – The number of the bits set (data bits and parity bit) is odd. 10 = even – The number of the bits set (data bits and parity bit) is even.
	3	Data bits	0 = 7 A – The number of data bits is 7. 1 = 8 – The number of data bits is 8.
	5,4	Data flow control	00 = none A – the data flow control is deactivated 01 = XON/XOFF – Software-Handshake (XON/XOFF) is activated 10 = RTS/CTS – Hardware-Handshake (RTS/CTS) is activated.
	7,6	reserved	
2		XON-character	0 – 255 (17 A) XON-character: This character is used to start the data transfer of the data terminal device (DTE) when the software-handshake is activated
3		XOFF-character	0 – 255 (19 A) XOFF-character: This character is used to stop the data transfer of the data terminal device (DTE) when the software-handshake is activated

- XN-1RS485/422

Table 33:
Module
parameters**A** Default-
settings

Byte	Bit	Parameter name	Value
0	3 to 0	Data rate	0000 = 300 bps
			0001 = 600 bps
			0010 = 1200 bps
			0100 = 2400 bps
			0101 = 4800 bps
			0110 = 9600 bps A
			0111 = 14400 bps
			1000 = 19200 bps
			1001 = 28800 bps
			1010 = 38400 bps
			1011 = 57600 bps
			1100 = 115200 bps
			... = reserved
4		Select RS485	0 = parameterization as RS422 1 = parameterization as RS485
5		reserved	
6		Disable ReducedCtrl	Constant setting: – The diagnosis messages are set in Byte 6 of the process input data (independent of "diagnostic"). Byte 6 of the process output data contains two bits which may set to flush the transmit- or the receive-buffer. – Byte 7 contains the status- or the control-byte. – Bytes 0 to 5 contain the user data.
7		Diagnostics	0 = release A 1 = block
1	0	Stop bits	0 = 1 bit A 1 = 2 bit
	2,1	Parity	00 = none 01 = odd A – The number of the bits set (data bits and parity bit) is odd. 10 = even – The number of the bits set (data bits and parity bit) is even.
	3	Data bits	0 = 7 A – The number of data bits is 7. 1 = 8 – The number of data bits is 8.

5 Implementation of Modbus TCP

5.9 Parameters of the modules

Table 33:
Module
parameters

	Byte	Bit	Parameter name	Value
A Default- settings	2		XON-character	0 – 255 (17 A) – Only in RS422-mode: XON-character: This character is used to start the data transfer of the data terminal device (DTE) when the software-handshake is activated
	3		XOFF-character	0 – 255 (19 A) – Only in RS422-mode XOFF-character: This character is used to stop the data transfer of the data terminal device (DTE) when the software-handshake is activated

- XN-1SSI

Table 34:
Module
parameters

A Default-
settings

Byte	Bit	Parameter name	Value
0	4 to 0	reserved	
	5	Encoder data cable test	0 = activate A – ZERO test of data cable. 1= deactivate – After the last valid bit, a ZERO test of the data cable is not carried out.
	7,6	reserved	
1	3 to 0	Number of invalid bits (LSB)	0000 to 1111: Number of invalid bits on the LSB side of the position value supplied by the SSI encoder. The meaningful word width of the position value transferred to the module bus master is as follows: SSI_FRAME_LEN - INVALID_BITS_MSB - INVALID_BITS_LSB. The invalid bits on the LSB side are removed by shifting the position value to the right, starting with the LSB.(Default 0 bit = 0x0). INVALID_BITS_MSB + INVALID_BITS_LSB must always be less than SSI_FRAME_LEN.
	6 to 4	Number of invalid bits (MSB)	000 to 111: Number of invalid bits on the MSB side of the position value supplied by the SSI encoder. The meaningful word width of the position value transferred to the module bus master is as follows: SSI_FRAME_LEN - INVALID_BITS_MSB - INVALID_BITS_LSB. The invalid bits on the MSB side are zeroed by masking the position value. INVALID_BITS_MSB + INVALID_BITS_LSB must always be less than SSI_FRAME_LEN. Default: 0 = 0hex
	7	reserved	

5 Implementation of Modbus TCP

5.9 Parameters of the modules

Table 34:
Module
parameters

Byte	Bit	Parameter name	Value
2	3 to 0	Data rate	0000 = 1000000 bps 0001 = 500000 bps A 0010 = 250000 bps 0011 = 125000 bps 0100 = 100000 bps 0101 = 83000 bps 0110 = 71000 bps 0111 = 62500 bps ... = reserved
	7 to 4	reserved	
3	5 to 0	Data frame bits	00000 to 100000 Number of bits of the SSI data frame. SSI_FRAME_LEN must always be greater than INVALID_BITS. Default: 25 = 19hex
	6	reserved	
	7	Data format	binary coded A – SSI encoder sends data in binary code GRAY coded – SSI encoder sends data in Gray code

5 Implementation of Modbus TCP

5.9 Parameters of the modules

- XNE-1SWIRE

	Bit 7	Bit 6	Bit 5	Bit 4	Bit 3	Bit 2	Bit 1	Bit 0
Byte 1	reserved	free	free	MC	MNA	Configura- tion	Disable Cfg	free
Byte 2	free	U _{AUXERR}	TYP _{ERR}	TYP _{INFO}	PKZ _{ERR}	PKZ _{INFO}	SD _{ERR}	SD _{INFO}
Byte 3	reserved							
Byte 4	reserved (lifeguarding time up to version VN 01-03)							
Byte 5	SC _{DIAGS8}	SC _{DIAGS7}	SC _{DIAGS6}	SC _{DIAGS5}	SC _{DIAGS4}	SC _{DIAGS3}	SC _{DIAGS2}	SC _{DIAGS1}
Byte 6	SC _{DIAGS16}	SC _{DIAGS15}	SC _{DIAGS14}	SC _{DIAGS13}	SC _{DIAGS12}	SC _{DIAGS11}	SC _{DIAGS10}	SC _{DIAGS9}
Byte 7	reserved							
Byte 8	reserved							
Byte 9 - 24	Type designation slave 1 - 16							

The following table shows the meaning of the parameter bits:

Table 35:
Module
parameters

A Default-
settings

Parameter name	Value
Byte 1	Disable Cfg Automatic SWIRE configuration If the physical structure of the SWIRE bus does not match the configuration stored in the XNE-1SWIRE on power up (SW LED flashing), the physical structure of the SWIRE bus must be stored in the XNE-1SWIRE.
	0 = inactive A Manual SWIRE configuration: To store the physical structure of the SWIRE bus in the XNE-1SWIRE, the CFG button of the XNE-1SWIRE must be pressed manually (only functions if the SW LED is flashing).
	1 = active Automatic SWIRE configuration: If the physical structure of the SWIRE bus does not match the configuration stored in the XNE-1SWIRE on power up, the physical structure is stored automatically in the XNE-1SWIRE.
Configura- tion	PLC configuration check If the PLC configuration check is activated, the configuration stored in the XNE-1SWIRE is compared with the SET configuration stored in the PLC.
	0 = active A The configuration stored in XNE-1SWIRE is compared with the SET configuration stored in the PLC. Only SWIRE slaves in the SWIRE bus are accepted that have a device ID completely matching the SET configuration.
	1 = inactive All slaves are mapped in 4Bit INPUT / 4Bit OUTPUT without checking the device ID.

5 Implementation of Modbus TCP

5.9 Parameters of the modules

Table 35:
Module
parameters

Para- meter name	Value
Byte 1	
MNA active/ passive	Configuration check Bus or slave-oriented configuration check (without function if MC = 1)
	0 = bus- oriented A If the PLC configuration check is activated, data exchange is only started if the configuration stored in the XNE-1 SWIRE fully matches the SET configuration stored in the PLC. Modifying the bus during operation causes the system to be aborted.
	1 = slave- oriented If the PLC configuration check is activated, data exchange is started with all SWIRE slaves that match the SET configuration stored in the PLC. The SWIRE slaves that do not match the SET configuration stored in the PLC do not perform any data exchange.
MC	Moeller conformance (from version VN 01-04) Behavior of the XNE-1 SWIRE in accordance with SWIRE Conformance criteria.
	0 = inactive A Default behavior
	1 = active The XNE-1 SWIRE master responds according to the Moeller SWIRE Conformance criteria (see manual for the IO-modules MN05002016Z).
Byte 2	
SD _{INFO}	Field -Slave error- Activate slave diagnostics info field SD _{ERR} Sx. As soon as a slave on the bus sets its error bit, this is indicated as an individual error depending on the parameter setting.
	0 = active A Single diagnostics is activated
	1 = inactive Single diagnostics is not activated

Table 35:
Module
parameters

Parameter name	Value
Byte 2	
SD _{ERR}	<p>Group error -Slave error- Activate slave diagnostics SD_{ERR}. As soon as only one slave on the bus sets its error bit, this is indicated as a group error depending on the parameter setting.</p> <p>0 = active A Group diagnostics is activated</p> <p>1 = inactive Group diagnostics is not activated</p>
PKZ _{INFO}	<p>Field -PKZ error- Activate slave diagnostics info field PKZ_{ERR}Sx. As soon as a SWIRE-DIL slave on the bus clears its PKZ bit, this is indicated as an individual error depending on the parameter setting.</p> <p>0 = active A Single diagnostics is activated</p> <p>1 = inactive Single diagnostics is not activated</p>
PKZ _{ERR}	<p>Group error -PKZ error- Activate slave diagnostics PKZ_{ERR}. As soon as only one SWIRE-DIL slave on the bus clears its PKZ bit, this is indicated as a group error depending on the parameter setting.</p> <p>0 = active A Group diagnostics is activated</p> <p>1 = inactive Group diagnostics is not activated</p>
TYP _{INFO}	<p>Field -Configuration error- Activate slave diagnostics info field TYP_{ERR}Sx. As soon as a slave on the bus does not match the set configuration and therefore cannot be started, this is indicated as an individual error depending on the parameter set.</p> <p>0 = active A Single diagnostics is activated</p> <p>1 = inactive Single diagnostics is not activated</p>
TYP _{ERR}	<p>Group error -Configuration error- Activate slave diagnostics TYP_{ERR}. As soon as only one slave on the bus is incorrectly configured, this is indicated as a group error depending on the parameter setting.</p> <p>0 = active A Group diagnostics is activated</p> <p>1 = inactive Group diagnostics is not activated</p>
U _{AUXERR}	<p>Error message -U_{AUX}- Activate system diagnostics U_{AUXERR}. U_{AUXERR} will generate an error message as soon as the power supply goes below a level at which the function of the relays is not guaranteed.</p> <p>0 = active A Error message U_{AUXERR} activated</p> <p>1 = inactive Error message U_{AUXERR} not activated</p>
Byte 3	reserved

5 Implementation of Modbus TCP

5.9 Parameters of the modules

Table 35:
Module
parameters

Parameter name	Value	
Byte 4		
reserved (Life-guarding time only up to version VN01-03)	0x02-0xFF 0x64 A	Was up to version VN 01-03: Lifeguarding time of the SWIRE slaves. Setting of lifeguarding time, timeout time up to automatic reset of the slaves in the event of communication failure. (n × 10 ms) (Default 1s) 0xFF: Lifeguarding off
Byte 5, 6		
SC _{DIAG} Sx		Input bit communication error, slave x Slave diagnostics message from Byte 1 / Bit 7 is accepted in the feedback interface as Bit4.
	0 = active A	SC _{DIAG} Sx is accepted
	1 = inactive	SC _{DIAG} Sx is not accepted
Byte 7, 8	reserved	
Byte 9 bis 24		
Device ID, slave x		TYPE setting for the SWIRE slave at position x on the SWIRE bus
	0x20	SWIRE-DIL (Moeller)
	0x21	SWIRE-4DI-2DO-R (Moeller)
	0x01	PH9285.91 (Dold)
	0x02	PH9285.91/001 (Dold)
	0x03	PH9285.91/002 (Dold)
	0xFF	Basic setting (no slave)

5.10 Diagnostic messages of the modules

5.10.1 Power supply modules

- XN-BR-24VDC-D

Table 36:
XN-BR-24VDC-
D

Diagnosis byte	Bit	Diagnosis
n	0	Module bus voltage warning: – Monitoring of the externally provided system supply voltage ($U_{SYS} = 24 \text{ V DC}$). The system supply is converted ($24 \text{ V DC} \Rightarrow 5 \text{ V}$).
	1	reserved
	2	Field voltage missing: – Monitoring of the externally provided field supply voltage. $U_L = 24 \text{ V DC}$.
	3	reserved

- XN-PF-24VDC-D

Table 37:
XN-PF-24VDC-D

Diagnosis byte	Bit	Diagnosis
n	0	reserved
	1	reserved
	2	Field voltage missing: – Monitoring of the externally provided field supply voltage. $U_L = 24 \text{ V DC}$.
	3	reserved

- XN-PF-120/230VAC-D

Table 38:
XN-PF-
120/230VAC-D

Diagnosis byte	Bit	Diagnosis
n	0	reserved
	1	reserved
	2	Field voltage missing: – Monitoring of the externally provided field supply voltage. $U_L = 120 \text{ or } 230 \text{ V AC}$.
	3	reserved

5 Implementation of Modbus TCP

5.10 Diagnostic messages of the modules

5.10.2 Analog input modules

- XN-1AI-I(0/4...20MA)

Table 39:
XN-1AI-I
(0/4...20MA)

Diagnosis byte	Bit	Diagnosis
n (channel 1)	0	Measurement value range error: Indication of overcurrent or undercurrent of 1 % of the set current range. – Current 0...20 mA: – Overcurrent: I_{\max} ($I > 20.2$ mA); – Undercurrent is not detected. – Current 4...20 mA: – Overcurrent: I_{\max} ($I > 20.2$ mA); – Undercurrent: I_{\min} ($I < 3.8$ mA)
	1	Wire break: – Indication of a wire break in the signal cable for operating mode 4...20 mA with a threshold of 3 mA.

- XN-2AI-I(0/4...20MA)

Table 40:
XN-2AI-I
(0/4...20MA)

Diagnosis byte	Bit	Diagnosis
n (channel 1)	0	Measurement value range error: Indication of overcurrent or undercurrent of 1 % of the set current range. – Current 0...20 mA: – Overcurrent: I_{\max} ($I > 20.2$ mA); – Undercurrent is not detected. – Current 4...20 mA: – Overcurrent: I_{\max} ($I > 20.2$ mA); – Undercurrent: I_{\min} ($I < 3.8$ mA)
	1	Wire break: – Indication of a wire break in the signal cable for operating mode 4...20 mA with a threshold of 3 mA.
n + 1 (channel 2)	0	Measurement value range error: Indication of overcurrent or undercurrent of 1 % of the set current range. – Current 0...20 mA: – Overcurrent: I_{\max} ($I > 20.2$ mA); – Undercurrent is not detected. – Current 4...20 mA: – Overcurrent: I_{\max} ($I > 20.2$ mA); – Undercurrent: I_{\min} ($I < 3.8$ mA)
	1	Wire break: – Indication of a wire break in the signal cable for operating mode 4...20 mA with a threshold of 3 mA.

- XN-1AI-U(-10/0...+10VDC)

Table 41:
XN-1AI-U
(-10/0...+10VDC)

Diagnosis byte	Bit	Diagnosis
n (channel 1)	0	Measurement value range error: Indication of overvoltage or undervoltage of 1% of the set voltage range. – Voltage -10...+10 V DC: – Overvoltage: U_{max} ($U > 10.1$ V DC) – Undervoltage: U_{min} ($U < -10.1$ V DC) – Voltage 0...+10 V DC: – Overvoltage: U_{max} ($U > 10.1$ V DC) – Undervoltage: U_{min} ($U < 0.1$ V DC)

- XN-2AI-U(-10/0...+10VDC)

Table 42:
XN-2AI-U
(-10/0...+10VDC)

Diagnosis byte	Bit	Diagnosis
n (channel 1)	0	Measurement value range error: Indication of overvoltage or undervoltage of 1% of the set voltage range. – Voltage -10...+10 V DC: – Overvoltage: U_{max} ($U > 10.1$ V DC) – Undervoltage: U_{min} ($U < -10.1$ V DC) – Voltage 0...+10 V DC: – Overvoltage: U_{max} ($U > 10.1$ V DC) – Undervoltage: U_{min} ($U < 0.1$ V DC)
n + 1 (channel 2)	0	

- XN-2AI-PT/NI-2/3

Table 43:
XN-2AI-PT/NI-
2/3

Diagnosis byte	Bit	Diagnosis
n (channel n), n=1,2	0	Measurement value range error: – Unterflow diagnostics only in temperature measurements – Threshold: 1 % of the positive measurement range limit value
	1	Wire break
	2	Short-circuit (only in temperature measurements): – Threshold: 5 Ω (loop resistance) – With 3-wire measurements with PT100 sensors, no distinction is made between short-circuit and wire break at a temperature below -177 °C. In this case, the “Short-circuit” diagnostic signal is generated.
	3 to 7	reserved

5 Implementation of Modbus TCP

5.10 Diagnostic messages of the modules

- XN-2AI-THERMO-PI

Table 44:
XN-2AI-
THERMO-PI

Diagnosis byte	Bit	Diagnosis
n (channel n), n=1,2	0	Measurement value range error: – Threshold: 1 % of the positive measurement range limit value – With type K, N and T sensors, the “Underflow” diagnostic signal is generated on temperatures below -271.6 °C.
	1	Wire break (only in temperature measurements)
	2 to 7	reserved

- XN-4AI-U/I

Table 45:
XN-4AI-U/I

Diagnosis byte	Bit	Diagnosis
n (channel n), n=1...4	0	Measurement value range error: Indication of overvoltage or undervoltage of 1% of the set voltage range or indication of overcurrent or undercurrent of 1 % of the set current range. – Voltage -10...+10 V DC: – Overvoltage: U_{max} ($U > 10.1$ V DC) – Undervoltage: U_{min} ($U < -10.1$ V DC) – Voltage 0...+10 V DC: – Overvoltage: U_{max} ($U > 10.1$ V DC) – Undervoltage: U_{min} ($U < 0.1$ V DC) – Current 0...20 mA: – Overcurrent: I_{max} ($I > 20.2$ mA); – Undercurrent is not detected. – Current 4...20 mA: – Overcurrent: I_{max} ($I > 20.2$ mA); – Undercurrent: I_{min} ($I < 3.8$ mA)
	1	Wire break: – Indication of a wire break in the signal cable for operating mode 4...20 mA with a threshold of 3 mA.
	2 to 7	reserved

- XNE-8AI-U/I-4PT/NI

Table 46:
XNE-8AI-U/I-
4AI-PT/NI

	Diagnosis byte	Bit	Diagnosis
<p>A The switching thresholds depend on the setting of the module parameter operation mode Kx, see manual MN05002011Z</p>	n (channel n), n=1...8	0	Measurement value range error "Out of Range" (OoR) A : – The measured value oversteeps or undercuts the limit of the nominal range (limit values according to parameterization).
		1	Wire break (WB) A : – The measured value is in the range which is assumed that there is a wire break in the signal cable. – In temeperature measurements – In resistance measurements – In current measurements in the range of 4...20 mA
		2	Short-circuit (SC): – The measured value is in the range which is assumed that there is a short-circuit. – In temeperature measurements: Threshold: 5 Ω (loop resistance) – 3-wire measurements with PT100 sensors cannot differentiate between a short-circuit and a wire break at temperatures below -177 °C. In this case, the diagnostic "shortcircuit" is generated.
		3	Overflow / Underflow (OUFL): – The measured value exceeds the measurement range (limit values according to parameterization). The module cannot measure this value. The return value is the maximum or minimum value which can be measured.
		4 to 6	reserved
		7	Hardware error (HW Error): – Exampels: CRC error, calibration errors... – The return value of the measured value is "0".

5 Implementation of Modbus TCP

5.10 Diagnostic messages of the modules

5.10.3 Digital output modules

- XN-2DO-24VDC-0.5A-P

Table 47:
XN-2DO-
24VDC-0.5A-P

Diagnosis byte	Bit	Diagnosis
n	0	overcurrent (short-circuit), channel 1)
	1	overcurrent (short-circuit), channel 2)

- XN-2DO-24VDC-0.5A-N

Table 48:
XN-2DO-
24VDC-0.5A-N

Diagnosis byte	Bit	Diagnosis
n	0	overcurrent (short-circuit), channel 1
	1	overcurrent (short-circuit), channel 2

- XN-2DO-24VDC-2A-P

Table 49:
XN-2DO-
24VDC-2A-P

Diagnosis byte	Bit	Diagnosis
n	0	overcurrent (short-circuit), channel 1
	1	overcurrent (short-circuit), channel 2

- XN-4DO-24VDC-0.5A-P

Table 50:
XN-4DO-
24VDC-0.5A-P

Diagnosis byte	Bit	Diagnosis
n	0	overcurrent (short-circuit), at least 1 channel

- XN-16DO-24VDC-0.5A-P

Table 51:
XN-16DO-
24VDC-0.5A-P

Diagnosis byte	Bit	Diagnosis
n	0	Overcurrent (short-circuit), channel 1-4
	1	Overcurrent (short-circuit), channel 5-8
	2	Overcurrent (short-circuit), channel 9-12
	3	Overcurrent (short-circuit), channel 13-16

- XN-32DO-24VDC-0.5A-P

Table 52:
XN-32DO-
24VDC-0.5A-P

Diagnosis byte	Bit	Diagnosis
n	0	Overcurrent (short-circuit), channel 1-4
	1	Overcurrent (short-circuit), channel 5-8
	2	Overcurrent (short-circuit), channel 9-12
	3	Overcurrent (short-circuit), channel 13-16
	4	Overcurrent (short-circuit), channel 17-20
	5	Overcurrent (short-circuit), channel 21-24
	6	Overcurrent (short-circuit), channel 25-28
	7	Overcurrent (short-circuit), channel 29-32

5.10.4 Analog output modules

- XNE-4AO-U/I

Table 53:
XN-4AO-U/I

Diagnosis byte	Bit	Diagnosis
A The switching thresholds depend on the setting of the module parameter operation mode Kx, see manual MN05002011Z n (channel n), n=1...4	0	Output value range error "Out of Range" (OoR) A : – The set output value oversteeps or undercuts the limit of the nominal range (limit values according to parameterization).
	1	reserved
	2	reserved
	3	Overflow / Underflow (OUFL) A : – The set output value exceeds the output range (limit values according to parameterization). The module cannot transmit this value. The output value is the maximum or minimum value which can be outputted.
	4 to 6	reserved
	7	Hardware error (HW Error): – Exampels: CRC error, calibration errors... – The output value of the analog value is "0".

5 Implementation of Modbus TCP

5.10 Diagnostic messages of the modules

5.10.5 Technology modules

- XN-1CNT-24VDC

Table 54:
XN-1CNT-
24VDC

Diagnosis byte	Bit	Diagnosis
n When bit 7 = 0 (count mode)	0	Short-circuit / wire break → ERR_DO
	1	Short-circuit in sensor power supply → ERR-24VDC
	2	End of counter range wrong
	3	Start of counter range wrong
	4	Invert-DI+latch-retr. not perm. It is not permitted to invert the level of the digital input when using the latch-retrigger-function
	5	Main count direction wrong
	6	Operating mode wrong
	7	Count mode Bit = 0 Count mode is active
n When bit 7 = 1 (measurement mode)	0	Short-circuit / wire break → ERR_DO
	1	Short-circuit in sensor power supply → ERR-24VDC
	2	Sensor pulse wrong
	3	Integration time wrong
	4	Upper limit wrong
	5	Lower limit wrong
	6	Operating mode wrong
	7	Measurement mode Bit = 1 measurement mode is active

5 Implementation of Modbus TCP

5.10 Diagnostic messages of the modules

- XNE-2CNT-2PWM

	Bit 7	Bit 6	Bit 5	Bit 4	Bit 3	Bit 2	Bit 1	Bit 0
Byte 0	HW_ERR	CNT1_ PAR_ERR	X	X	X	X	X	X
Byte 1	HW_ERR	CNT2_ PAR_ERR	X	X	X	X	X	X
Byte 2	HW_ERR	PWM1_ PAR_ERR	X	X	X	X	P1_DIAG	D1_DIAG
Byte 3	HW_ERR	PWM2_ PAR_ERR	X	X	X	X	P2_DIAG	D2_DIAG

The following table shows the meaning of the diagnostics bits:

Table 55:
Diagnostics of
the XNE-2CNT-
2PWM

Diagnostic message	Values	Meaning
CNT1_PAR_ERR, CNT2_PAR_ERR, PWM1_PAR_ERR, PWM2_PAR_ERR	0	Parameter set of function unit correct
	1	Faulty / inconsistent parameters, wrong parameterization
P1_DIAG, P2_DIAG, D1_DIAG, D2_DIAG	0	No diagnostic message
	1	Diagnosis pending at channel (short circuit)
HW_ERR	0	No diagnostic message
	1	Hardware error: – Display of common errors of the module's hardware (e.g. CRC-error, adjustment error...) – Change of device necessary.

5 Implementation of Modbus TCP

5.10 Diagnostic messages of the modules

- XN-1RS232

Table 56:
XN-1RS232

Diagnosis byte	Bit	Diagnosis
n	0	Parameterization error
	1	Hardware failure
	2	Data flow control error
	3	Frame error
	4	Buffer overflow

- XN-1RS485/422

Table 57:
XN-1RS485/422

Diagnosis byte	Bit	Diagnosis
n	0	Parameterization error
	1	Hardware failure
	2	Data flow control error (only in RS422-mode)
	3	Frame error
	4	Buffer overflow

- XN-1SSI

Table 58:
XN-1SSI

Diagnosis byte	Bit	Diagnosis
n	0	SSI group diagnostics
	1	Wire break
	2	Sensor value overflow
	3	Sensor value underflow
	4	Parameterization error

5 Implementation of Modbus TCP

5.10 Diagnostic messages of the modules

- XNE-1SWIRE

	Bit 7	Bit 6	Bit 5	Bit 4	Bit 3	Bit 2	Bit 1	Bit 0
Byte n	GENEAL _{ERR}	U _{SWERR}	free	COM _{ERR}	free	RDY _{ERR}	free	SW _{ERR}
Byte n+1	free	U _{AUXERR}	TYP _{ERR}	free	PKZ _{ERR}	free	SD _{ERR}	free
TYP_{ERR} Field								
Byte n+2	TYP _{ERR} S8	TYP _{ERR} S7	TYP _{ERR} S6	TYP _{ERR} S5	TYP _{ERR} S4	TYP _{ERR} S3	TYP _{ERR} S2	TYP _{ERR} S1
Byte n+3	TYP _{ERR} S16	TYP _{ERR} S15	TYP _{ERR} S14	TYP _{ERR} S13	TYP _{ERR} S12	TYP _{ERR} S11	TYP _{ERR} S10	TYP _{ERR} S9
Slave Diagnostic Field								
Byte n+4	SD _{ERR} S8	SD _{ERR} S7	SD _{ERR} S6	SD _{ERR} S5	SD _{ERR} S4	SD _{ERR} S3	SD _{ERR} S2	SD _{ERR} S1
Byte n+5	SD _{ERR} S16	SD _{ERR} S15	SD _{ERR} S14	SD _{ERR} S13	SD _{ERR} S12	SD _{ERR} S11	SD _{ERR} S10	SD _{ERR} S9
PKZ Field								
Byte n+6	PKZ _{ERR} S8	PKZ _{ERR} S7	PKZ _{ERR} S6	PKZ _{ERR} S5	PKZ _{ERR} S4	PKZ _{ERR} S3	PKZ _{ERR} S2	PKZ _{ERR} S1
Byte n+7	PKZ _{ERR} S16	PKZ _{ERR} S15	PKZ _{ERR} S14	PKZ _{ERR} S13	PKZ _{ERR} S12	PKZ _{ERR} S11	PKZ _{ERR} S10	PKZ _{ERR} S9

The following table shows the meaning of the diagnostics bits:

Table 59:
Meaning of
diagnostics
data bits

	Designation	Value	Meaning
Byte 1			
	SW _{ERR}		SWIRE MASTER
			If the physical structure of the SWIRE bus does not match the configuration stored in the XNE-1SWIRE, this bit indicates an error.
		0	Data exchange The physical structure of the SWIRE bus was accepted and the SWIRE bus is in operation.
		1	Offline The physical structure was not accepted, the SWIRE bus does not start operation (SW LED flashing).
	RDY _{ERR}		PLC SLAVE
			This bit indicates an error if the configuration stored in the XNE-1SWIRE does not match the SET configuration stored in the PLC.
		0	OK No error present. The SWIRE bus is ready for data exchange.
		1	Offline The configuration stored in the XNE-1SWIRE was not accepted. The data exchange is prevented (RDY LED flashing).

5 Implementation of Modbus TCP

5.10 Diagnostic messages of the modules

Table 59:
Meaning of
diagnostics
data bits

Designation	Value	Meaning
-------------	-------	---------

COM _{ERR}	Communication SWIRE	
	A communication error is present, such as a slave is no longer reached, its internal timeout has elapsed or communication is faulty. The master cannot carry out data exchange with at least one slave.	
	0	OK No error present.
	1	faulty An error is present.
U _{SWERR}	Voltage U _{SW}	
	Voltage fault in U _{SW} , voltage U (17 VDC) for supplying the SWIRE slaves	
	0	OK No error present.
	1	Under-voltage An error is present.
GENERAL _{ERR}	Error message	
	The creation of a function block shows that systems / function blocks for the general checking of a slave for any diagnostics messages present only check the first byte.	
	0	None No diagnostics message present.
	1	Present One/several diagnostics messages present.
Byte 2		
SD _{ERR}	Communication SWIRE slave	
	If the parameter SD _{ERR} is set for group diagnostics, this bit indicates an error as soon as only one slave on the bus sets its SD _{ERR} error bit.	
	0	OK No error is present or diagnostics function has been deactivated via the parameter setting.
	1	faulty An error is present.
PKZ _{ERR}	Overcurrent protective circuit-breaker	
	If the parameter PKZ _{ERR} is set for group diagnostics, this bit indicates an error as soon as only one PKZ of a slave has tripped.	
	0	OK No PKZ has tripped or diagnostics function has been deactivated via the parameter setting.
	1	Tripping At least one PKZ has tripped.

Table 59:
Meaning of
diagnostics
data bits

Designation Value Meaning

Designation	Value	Meaning	
TYP _{ERR}	Configuration		
	If the TYP _{ERR} parameter is set with group diagnostics in the parameter setting, this bit indicates an error as soon as a PLC configuration check detects differing slave numbers, types or position of an SWIRE slave.		
	0	OK	The PLC configuration check was positive (the configuration stored in the XNE-1SWIRE matches the SET configuration stored in the PLC) or the diagnostics function is deactivated via the parameter setting.
	1	faulty	A mismatch was determined in the PLC configuration check.
U _{AUXERR}	Voltage U _{AUX}		
	If the U _{AUXERR} parameter is activated, U _{AUXERR} will generate an error message as soon as the power supply goes below the level at which the function of the relays is not guaranteed.		
	0	OK	Contactors supply voltage is o.k. (> 20 VDC) or diagnostics function has been deactivated via this parameter.
	1	Under-voltage	Contactors supply voltage is not o.k. (< 18 VDC).
Byte 3,4			
TYP _{ERR} Sx	Device configuration, slave x		
	Info field for the individual indication of a configuration error as error message. If the TYP _{INFO} parameter is set with individual diagnostics, the error is indicated in this bit field as soon as a PLC configuration check detects differing slave numbers, types or position of an SWIRE slave.		
	0	OK	No error is present and the slave is in data exchange mode or diagnostics function has been deactivated via the parameter setting.
	1	Incorrect	No error present and the slave is NOT in data exchange mode.

5 Implementation of Modbus TCP

5.10 Diagnostic messages of the modules

Table 59:
Meaning of
diagnostics
data bits

Designation	Value	Meaning
-------------	-------	---------

Byte 5,6

$SD_{ERR}Sx$	Communication, slave x	
	Info field for the individual indication of slave offline or slave diagnostics as error message. The fault is indicated in this bit field if the parameter setting SD_{INFO} is set with individual diagnostics.	
0	OK	No error is present or diagnostics function has been deactivated via the parameter setting.
1	Offline	The slave has set its diagnostics bit or the slave was in data exchange with the SWIRE master but is not any longer.

Byte 7,8

$PKZ_{ERR}Sx$	Only SWIRE-DIL: Overcurrent protective circuit-breaker slave x	
	Info field for the individual indication of the tripping of a motor-protective circuit-breaker (PKZ) as error message. If the PKZ_{INFO} is set for single diagnostics, this bit field indicates the error as soon as the PKZ of the slave Sx has tripped.	
0	OK	The PKZ of the slave has not tripped or diagnostics function has been deactivated via the parameter setting.
1	Tripped	The PKZ of the slave has tripped.



Note

The error messages $U_{AUX}ERR$, $TYPE_{ERR}$, $TYPE_{ERR}Sx$, PKZ_{ERR} , $PKZ_{ERR}Sx$, SD_{ERR} and $SD_{ERR}Sx$ can be deactivated via the parameter setting.

6 Application example: Modbus TCP

6.1 Network configuration



Note

In order to build up the communication between the XI/ON-gateway and a PLC/ PC or a network interface card, both devices have to be hosts in the same network.

The network is already defined by the default-settings in the XI/ON-gateways.

The default IP address for the XI/ON gateways is 192.168.1.xxx (see also Chapter 3.1.2 IP address, Page 23).

If necessary, please adjust the IP address of the PLC/ PC or the network interface card (see Chapter 6.2, Page 110).

6 Application example: Modbus TCP

6.2 Changing the IP address of a PC/ network interface card

6.2 Changing the IP address of a PC/ network interface card

6.2.1 Changing the IP address in Windows 2000/ Windows XP

The IP address is changed in the "Control Panel" in "Network and Dial-up Connections":

- 1 Open the folder "Local Area Connection" and open the dialog "Local Area Connection Properties" via the button "Properties" in the dialog "Local Area Connection Status".
- 2 Mark "Internet Protocol (TCP/IP)" and press the "Properties"-button to open the dialog "Internet Protocol (TCP/IP) Properties".

Figure 37:
Local Area
Connection
Properties

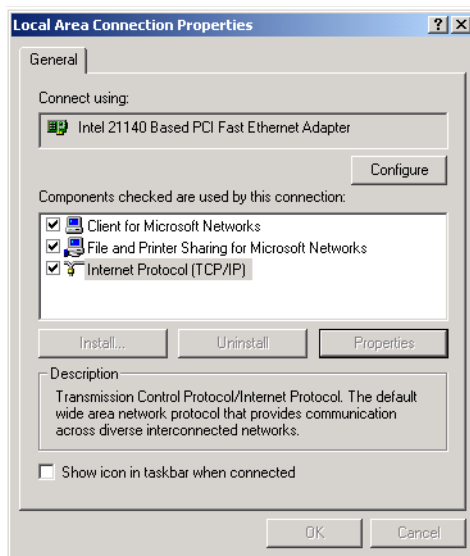

- 3 Activate "Use the following IP address" and assign an IP address of the network mentioned above to the PC/ Network interface card (see the following figure).

Figure 38:
Changing the
PC's IP address

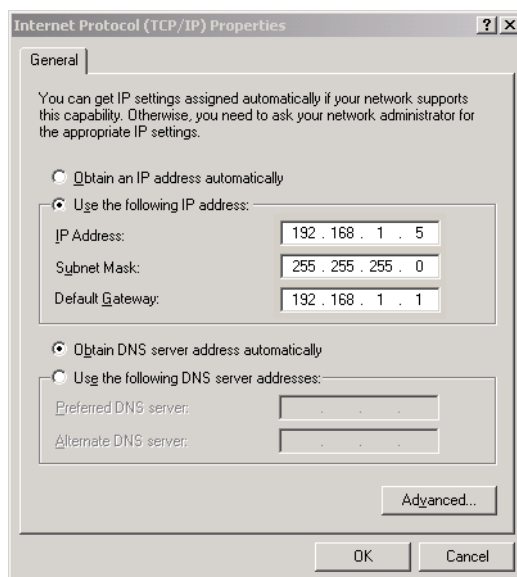

6.2.2 Changing the IP address in Windows NT

- 1 Open the folder "Network" in the Control Panel.
- 2 Activate TCP/IP connection in the tab "Protocols" and click the "Properties" button.

Figure 39:
Network
configuration
WIN NT

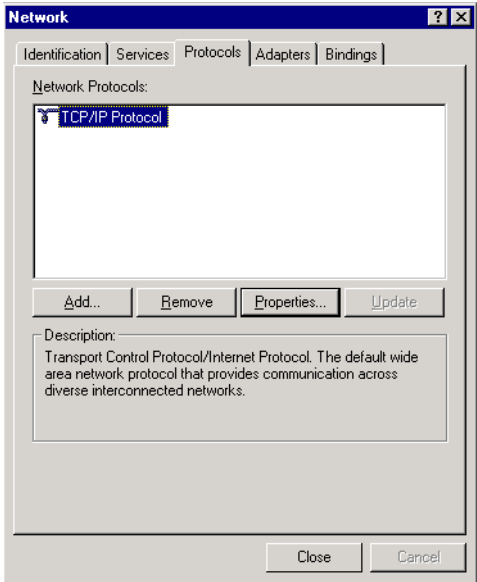

- 3 Activate "Specify IP address " and set the address as follows.

Figure 40:
Specify
IP address

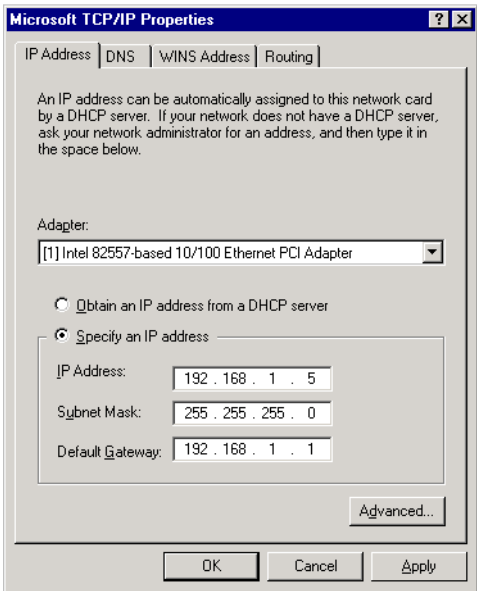

6 Application example: Modbus TCP

6.2 Changing the IP address of a PC/ network interface card

6.2.3 Changing the IP address via I/O-ASSISTANT

The Address Tool integrated in the software I/O-ASSISTANT offers the possibility to browse the whole Ethernet network for connected nodes and to change their IP address as well as the subnet mask according to the application.

Figure 41:
Address Tool
in the
I/O-ASSISTANT

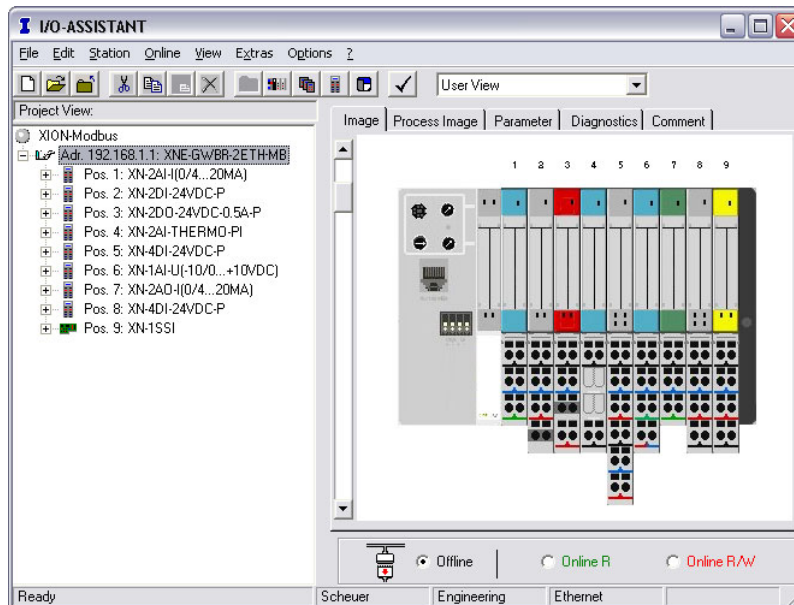

The network is browsed by using the search function in the Address Tool.

Figure 42:
Search function
in the Address
Tool

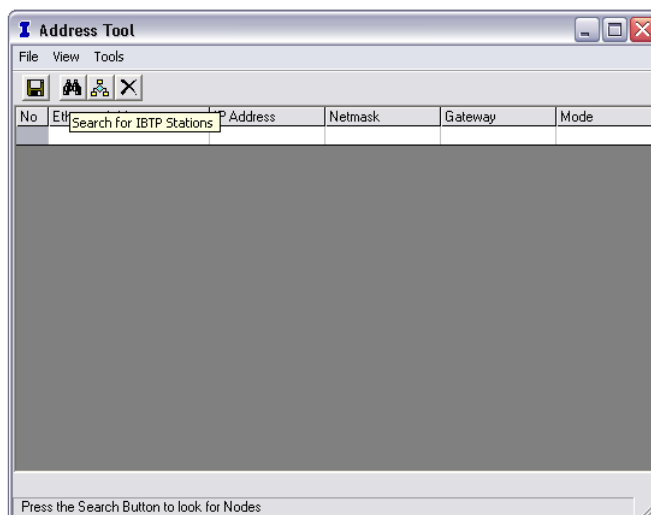

Attention

If Windows XP is used as operating system, problems with the system internal firewall may occur.

It may eventually inhibit the access of the I/O-ASSISTANT to the Ethernet. Please adapt your firewall settings accordingly or deactivate it completely (see also Chapter 6.2.4 Deactivating/ adapting the firewall in Windows XP, Page 114).

6.2 Changing the IP address of a PC/ network interface card

The network is browsed for connected hosts which are then listed in the Address Tool.

The address changing is done via "Tools → Changing IP settings...".

It is now possible to change the address settings for all nodes in the list or only for the selected one.

Figure 43:
Address changing for selected nodes

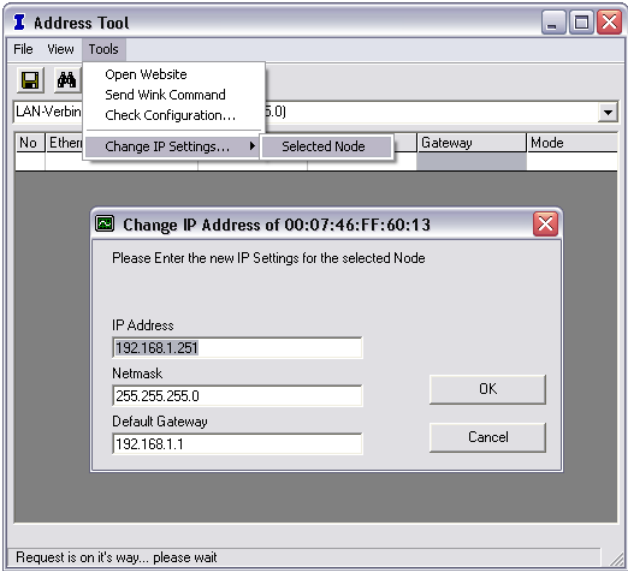

6 Application example: Modbus TCP

6.2 Changing the IP address of a PC/ network interface card

6.2.4 Deactivating/ adapting the firewall in Windows XP

If you use Windows XP as operating system, problems may occur when changing the IP addresses via the I/O-ASSISTANT.

In this case, you can deactivate the system integrated Windows XP firewall completely or adapt it to your application.

- **Deactivating the firewall**

Open the "Windows Firewall" dialog in the control panel of your PC and deactivate it as follows:

Figure 44:
Deactivating the
Windows fire-
wall

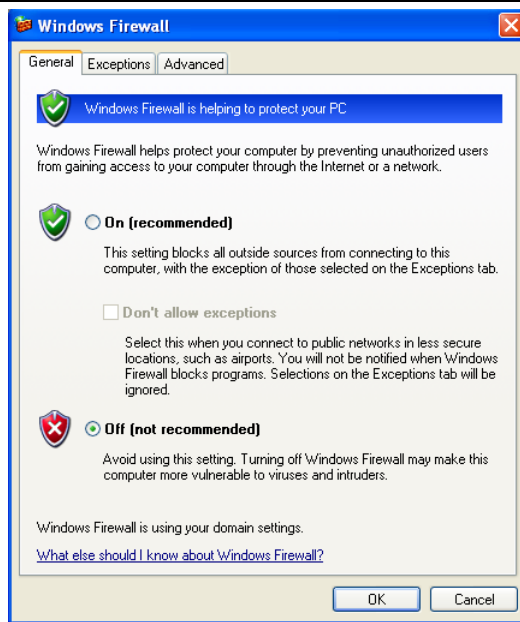

- **Adapting the firewall**

The firewall remains active, the option "Don't allow exceptions" is deactivated:

Figure 45:
Activating the
Windows fire-
wall

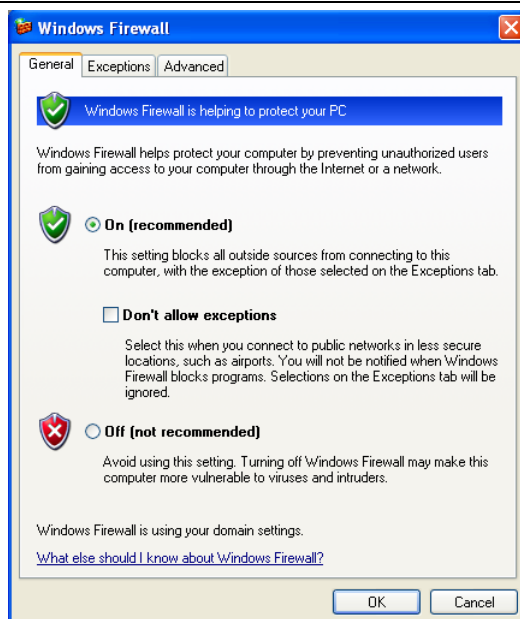

6.2 Changing the IP address of a PC/ network interface card

- In the "Exceptions"-tab, add the I/O-ASSISTANT to "Programs and Services".
- Pressing the button "Add Program..." opens the dialog "Add a Program". Select the I/O-ASSISTANT from the list of installed programs.
- If necessary, use the button "Browse..." to choose the file "IOassistant.exe" from the installation directory of the software.

Figure 46:
"Exceptions"-tab

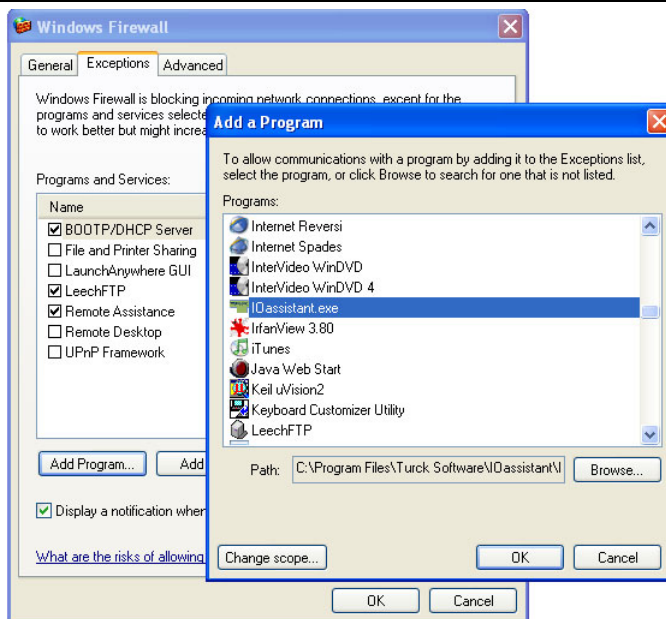

- Despite an active firewall, the I/O-ASSISTANT is now able to browse the network for hosts and the address changing via the software is possible for the connected nodes.

6 Application example: Modbus TCP

6.3 Communication examples: Modbus TCP

6.3 Communication examples: Modbus TCP

The next pages contain descriptions of different examples for Modbus TCP-communication as well as for the interpretation of the Modbus TCP-telegram.

The following XI/ON example station is used:

Table 60:
Example station

	Module	Data width		
		Proc. in	Proc. out	Alignment
GW	XNE-GWBR-2ETH-MB			
0	XN-2AI-I(0/4...20MA)	2 words	-	word by word
1	XN-2DI-24VDC-P	2 bits	-	bit by bit
2	XN-2DO-24VDC-0.5A-P	-	2 bits	bit by bit
3	XN-2AI-THERMO-PI	2 words	-	word by word
4	XN-4DI-24VDC-P	4 bits		bit by bit
5	empty slot			
6	XN-1AI-U(-10/0...+10VDC)	1 word	-	word by word
7	XN-2AO-I(0/4...20MA)		2 words	word by word
8	XN-4DI-24VDC-P	4 bits		bit by bit
9	XN-1SSI	4 words	4 words	word by word

The communication between PC and XI/ON-gateway is established via a standard network interface card and the software "Modbus Server Tester" from the Modbus organization (www.modbus.org).



Note

Detailed information concerning the register mapping, the implemented modbus functions, the module parameters and diagnostic messages can be found in Chapter 5 Implementation of Modbus TCP, Page 49 of this manual.

Figure 47:
 The software
 “Modbus Server
 Tester”

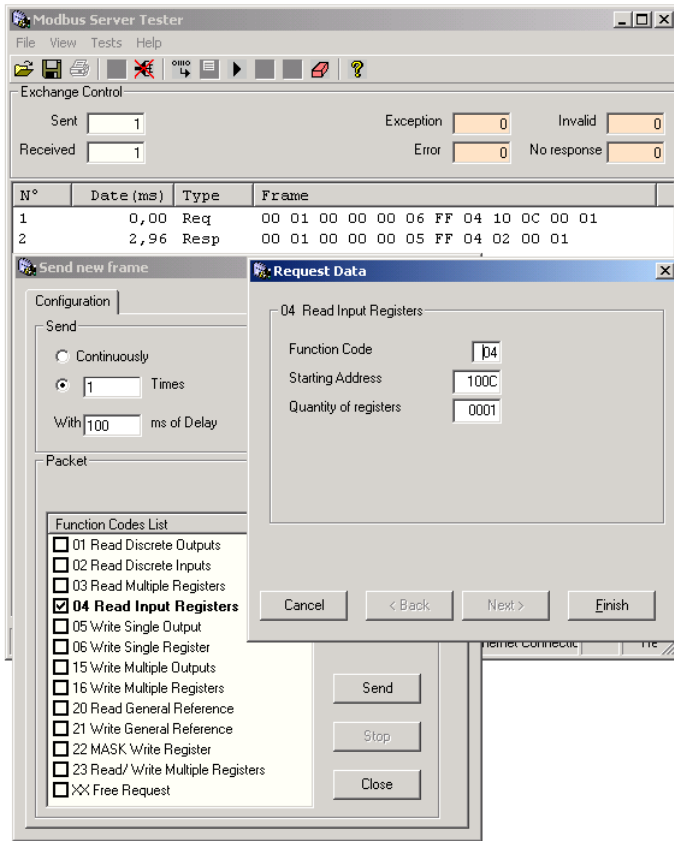

6 Application example: Modbus TCP

6.3 Communication examples: Modbus TCP

6.3.1 Reading-out the gateway-status

The gateway-status can be read from register 0x100C by using function code 04.

Figure 48:
Request:
gateway-status
(register
0x100C)

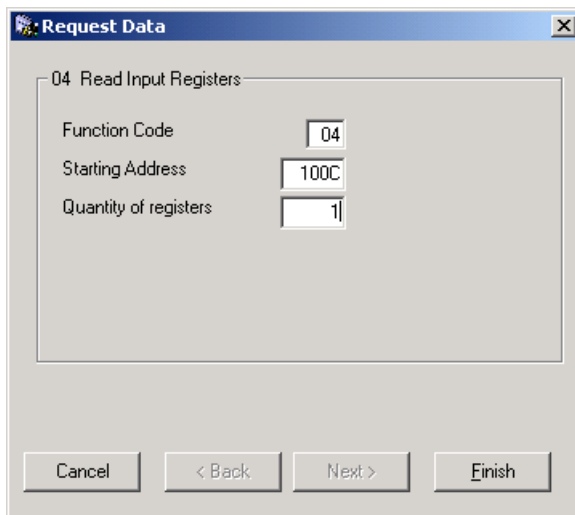

Gateway response:

Figure 49:
Gateway-status

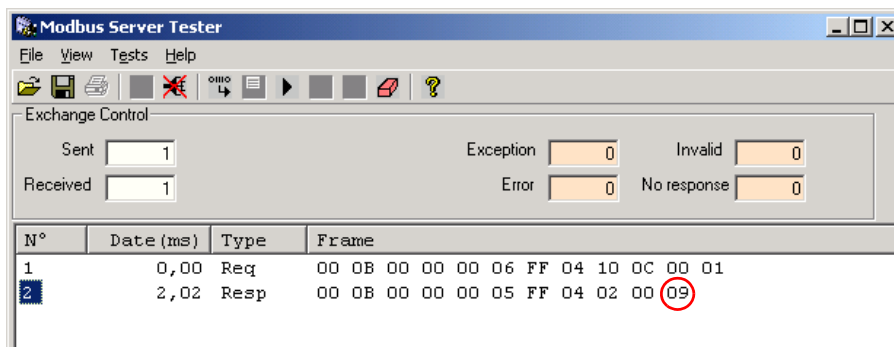

Status-register of the gateway:

Table 61:
Register 100Ch:
gateway-status

Byte	Value/ Meaning
– Byte 1	
bits 8 to 15	0
– Byte 0	0
bit 3	1 = I/O Cfg Modified Warning → The actual module list does not correspond to the reference module list stored in the gateway
bits 1 and 2	0 = reserved
bit 0	1 = I/O Diags Active Warning → At least one module in the station sends a diagnosis.

6.3.2 Reading-out the reference module list

The reference module list is stored in the register area 0x2800 to 0x2840. It can be read by using function code 03 "read multiple registers":

Figure 50:
 Reading out the reference module list

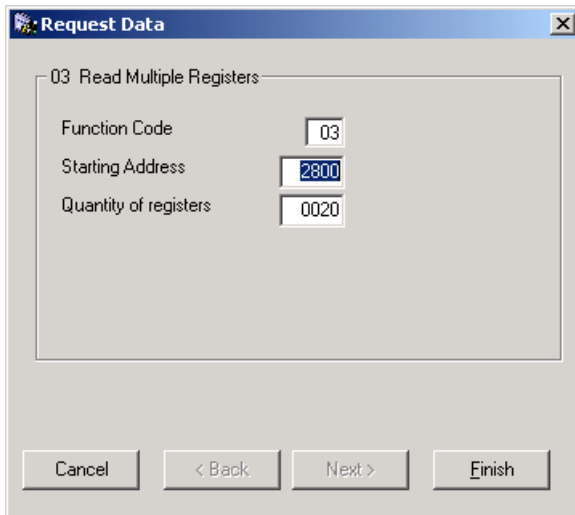
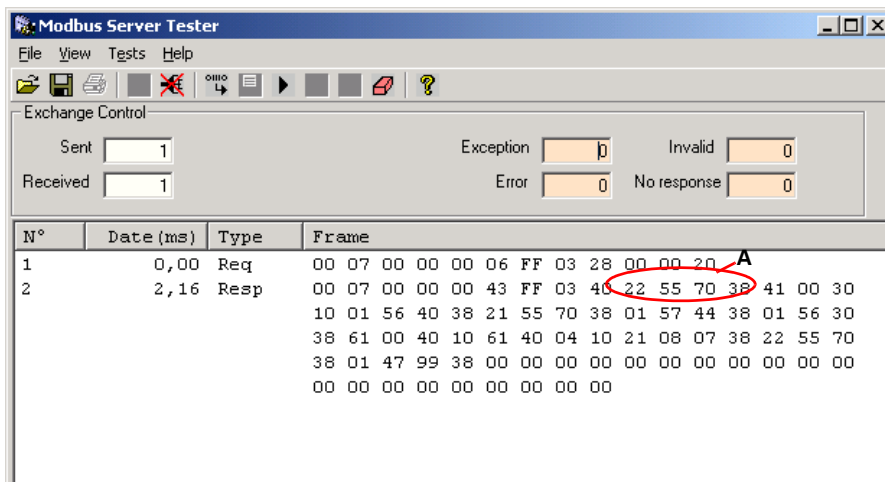

Figure 51:
 Reference module list
A Ident no. of module 0



Each module is clearly identified by a 4-byte ident-number. Bytes 3 to 1 define module type, Byte 0 is reserved for manufacturer specific data.

6 Application example: Modbus TCP

6.3 Communication examples: Modbus TCP

Module ident-numbers:

Table 62:
Ident-numbers
for the example
station

Ident-no.	Module
	XNE-GWBR-2ETH-MB
225570xx	0 XN-2AI-I(0/4...20MA)
210020xx	1 XN-2DI-24VDC-P
212002xx	2 XN-2DO-24VDC-0.5A-P
215570xx	3 XN-2AI-THERMO-PI
410030xx	4 XN-4DI-24VDC-P
00000000	5 empty slot
235570xx	6 XN-1AI-U(-10/0...+10VDC)
220807xx	7 XN-2AO-I(0/4...20MA)
410030xx	8 XN-4DI-24VDC-P
044799xx	9 XN-1SSI



Note

The complete list of XI/ON ident-numbers can be found in the Appendix of this manual.

6.3.3 Reading-out the actual module list

In order to compare both lists, the actual module list can be read from registers 0x2A00 to 0x2A40 using function code 03 again.

Figure 52:
 Reading the actual module list

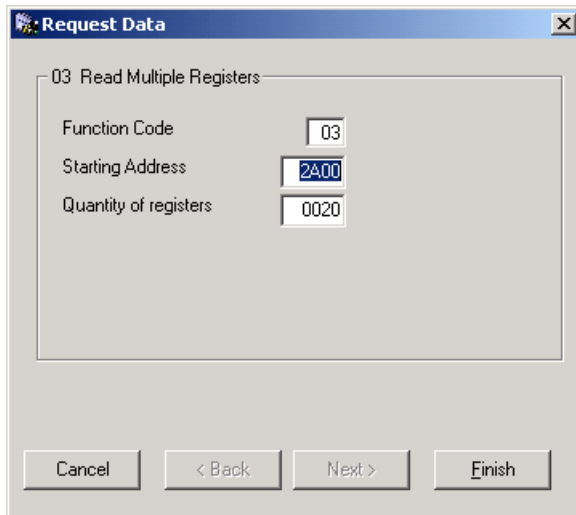

In this case, the actual module list shows a deviation from the reference module list at module position "4". No ident-no. could be read out.

→ Module **XN-2AI-THERMO-PI** is not found in the actual station configuration.

Figure 53:
 Actual module list

A empty slot, module pulled

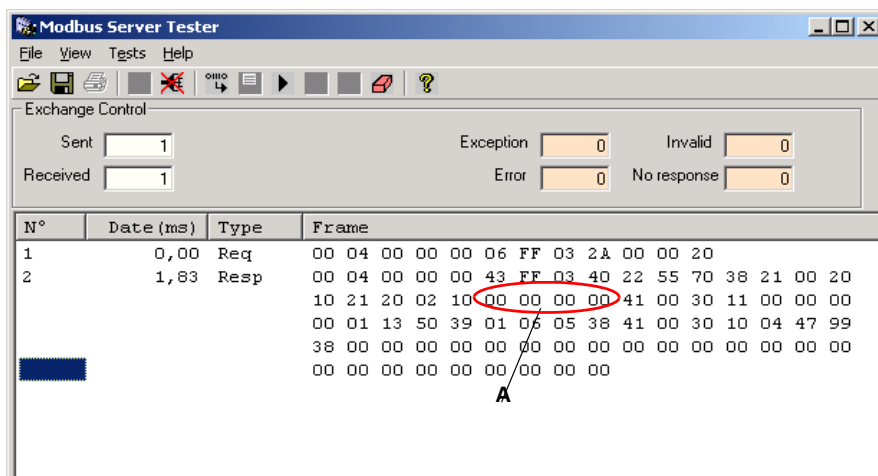

6 Application example: Modbus TCP

6.3 Communication examples: Modbus TCP

6.3.4 Reading-out the process image length (inputs)

Intelligent modules

The process image length of the intelligent input modules is read via function code 04 from register 1011:

Figure 54:
Process image
length (intelli-
gent input mo-
dules)

N°	Date (ms)	Type	Frame
1	0,00	Req	00 12 00 00 00 06 FF 04 10 11 00 01
2	1,82	Resp	00 12 00 00 00 05 FF 04 02 00 90

The process image length of the intelligent input modules is:
0x90 bits = 18 bytes = 9 registers

Table 63:
Process input
data of intelli-
gent modules

Module		Process input
		Words/ registers
0	XN-2AI-I(0/4...20MA)	2
3	XN-2AI-THERMO-PI	2
6	XN-1AI-U(-10/0...+10VDC)	1
9	XN-1SSI	4
Total		9

Digital modules

The process image length of the digital modules is also read via function code 04. The data are stored in register 0x1013:

Figure 55:
Process data
length of digital
input modules

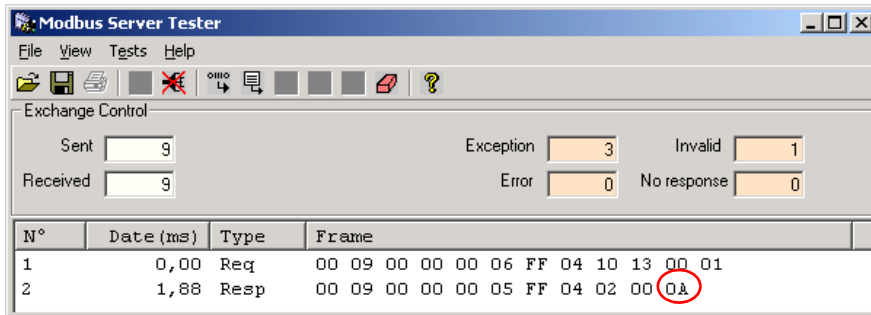

The process image length of all digital input modules of the example station is:
0x0A bits = 10 bits

Table 64:
Process input
data of digital
modules

Module	Process input
1 XN-2DI-24VDC-P	2 bits
4 XN-4DI-24VDC-P	4 bits
8 XN-4DI-24VDC-P	4 bits
Total	10 bits

6.3.5 Reading-out the packet process data (inputs)

In order to assure a largely efficient access to the process data of a station, the module data are consistently packed and mapped to a coherent register area.

The packed input data can be found in registers 0x0000 to 0x01FF of the gateway. They can be accessed via function code 03..

Figure 56:
Packed input
process data

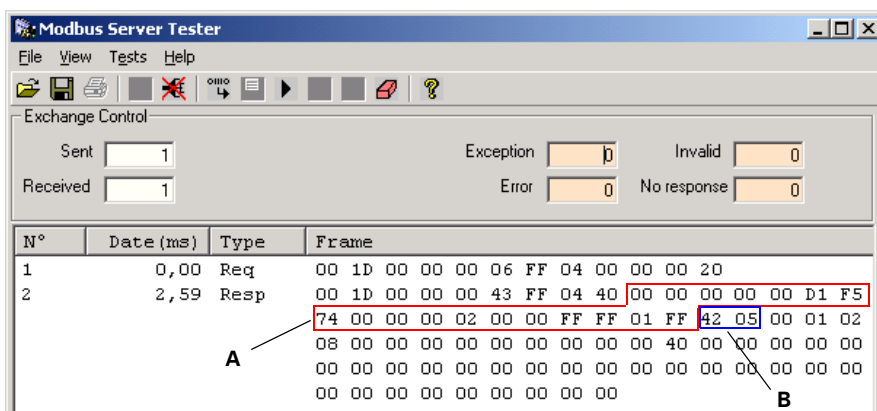

The first 9 registers (18 bytes) contain the input data of the intelligent modules "A", followed by 1 register of digital input data "B".

6 Application example: Modbus TCP

6.3 Communication examples: Modbus TCP

6.3.6 Evaluation of the packed process data (inputs)

Intelligent modules

The input data of the intelligent modules occupy 10 registers (**register 0x0000 to 0x0008**):

Figure 57:
Packed process
input data

N°	Date (ms)	Type	Frame
1	0,00	Req	00 1D 00 00 00 06 FF 04 00 00 00 20
2	2,59	Resp	00 1D 00 00 00 43 FF 04 40 00 00 00 00 00 D1 F5 74 00 00 00 02 00 00 FF FF 01 FF 42 05 00 01 02 08 00 00 00 00 00 00 00 00 00 40 00

- XN-2AI-I(0/4...20MA)
 - 2 registers (0x0000 and 0x0001)
 - channel 0: not used or input value at 0 mA in measurement range 0 to 20 mA
register 0x0000: 0x**00** 0x**00**
 - channel 1: not used or input value at 0 mA in measurement range 0 to 20 mA
register 0x0001: 0x**00** 0x**00**
→ The module shows the lower measurement limit when the channel is not used.

- XN-2AI-THERMO-PI
 - 2 registers (0x0002 and 0x0003)
 - channel 0: thermo element type K connected.
register 0x0002: 0x**00** 0x**D1**
→ The module shows a measured temperature of 0xD1 ≈ 21.0 °C at channel 0.
 - channel 1: no thermo element connected
register 0x0003: 0x**F5** 0x**74**
→ As the channel is not used, the module shows the minimum value at channel 1 (- 270 °C).

- XN-1AI-U(-10/0...10VDC)
 - 1 register (0x0004)
 - channel 0: register 0x0004: 0x**00** 0x**00**
→ As the module's voltage input is not used, no voltage can be measured.

6 Application example: Modbus TCP

6.3 Communication examples: Modbus TCP

– XN-1SSI
→ 4 registers (0x0005 to 0x0008)

- register 0x0006: 0x**00** 0x**02**
- register 0x0007: 0x**00** 0x**00**
- register 0x0008: 0x**FF** 0x**FF**
- register 0x0009: 0x**01** 0x**FF**

→ In the SSI module, the status and diagnosis information is shown in the first byte of the module's process input data.

Byte 0, bit 1 → the SSI module shows an error in the data image of the „Process input data“.

6 Application example: Modbus TCP

6.3 Communication examples: Modbus TCP

Digital modules

The input data of the digital modules occupy 1 register (**register 0x0009**):
Value: 0x02 0x05

- XN-2DI-24VDC-P
→ 2 bits
- register 0x0009:
byte 0, bits 0 and 1 ("0x01": input 0 = bit 0 = 1)
- XN-4DI-24VDC-P
→ 4 bits
- register 0x0009:
byte 0, bits 2 and 5 ("0x04": input 0 = bit 2 = 1)

N°	Date (ms)	Type	Frame
1	0,00	Req	00 10 00 00 00 06 FF 03 00 00 00 20
2	2,37	Resp	00 10 00 00 00 43 FF 03 40 00 03 00 02 00 00 00 00 00 0C 00 00 00 00 00 FF FF 01 FF 02 05 00 00 00 00 00 00 00 00 00 00 00 00 00 40 00

- XN-4DI-24VDC-P
→ 4 bits
- register 0x0009:
byte 0, bits 6 and 7 ("0x00": input 0 and 1 = 0)
byte 1, bits 0 and 1 ("0x02": input 3 = 1)

N°	Date (ms)	Type	Frame
1	0,00	Req	00 10 00 00 00 06 FF 03 00 00 00 20
2	2,37	Resp	00 10 00 00 00 43 FF 03 40 00 03 00 02 00 00 00 00 00 0C 00 00 00 00 00 FF FF 01 FF 02 05 00 00 00 00 00 00 00 00 00 00 00 00 00 40 00

6.3.7 Setting of outputs

Setting outputs is either done via the packed station process output data or via the module specific process output data (64 byte per module). The following example shows the access via the packed process output data, registers 0x0800 to 0x09FF.

Example:

Module 2, XN-2DO-24VDC-0.5A-P
→ setting the output channels 2:

- 1 In order to determine the register to be written, firstly the process image length of the intelligent output modules has to be read out.

Process data length, intelligent outputs:

Function code 04: register 0x1010

Value: 0x**60** = 96 bits = 6 registers

Figure 58:
reading out the
process data
length of intelli-
gent outputs

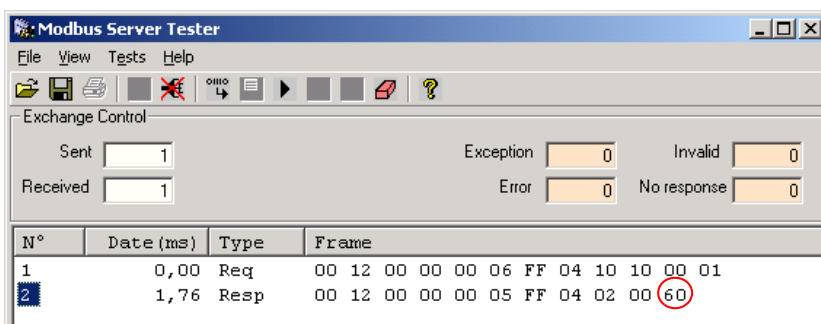

Table 65:
process data
length of intelli-
gent modules

Module	Process output Words/ registers
7 XN-2AO-I(0/4...20MA)	2
9 XN-1SSI	4
Total	6 registers

6 Application example: Modbus TCP

6.3 Communication examples: Modbus TCP

- Now, the process data length of the digital outputs is determined:
Process data length, digital outputs:
 Function code 04: register 0x1012

Value: 0x02 = 2 bits

Figure 59:
reading out the
process data
length of digital
outputs

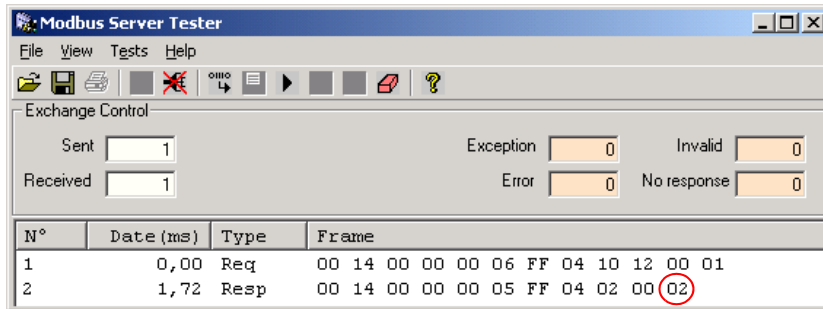

In the packed station process output data, the output data of the digital modules directly follow the packed output data of the intelligent modules (6 registers). They can thus be found in the register area 0x0800 to 0x09FF starting with register 0x0806.

Table 66:
Process data
length of digital
modules

Module	Process output
	Bit
2 XN-2DO-24VDC-0.5A-P	2 bits
Total	1 register

- In order to set the outputs 2 of module 3, the bit 1 of byte 0 in register 0x0806, have to be written.
 Function code 06, "Write Single register"

Value: 0x02 0x00:

Figure 60:
Setting outputs

- A register-no.
- B register-value

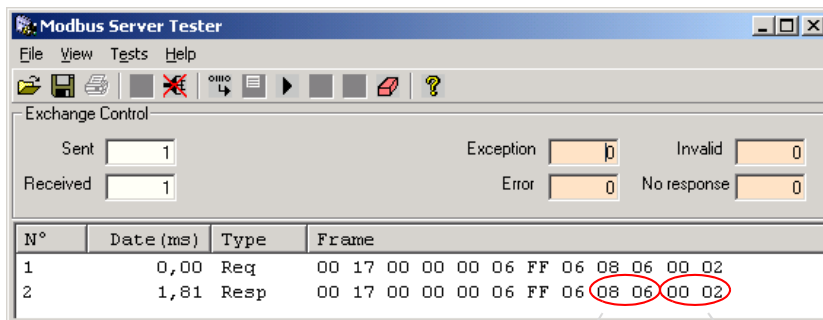

A B

6.4 Parameterization of modules

The parameters of the XI/ON-modules of one station can be accessed via register range 0xB000 to 0xB400.

For each module in the station, 64 bytes = 32 registers of parameter data are reserved.

The parameterization of XI/ON I/O-modules is described by means of the following examples:

- Example A:
 Module 0:
 - Changing the measurement range for channel 0 from "0 to 20 mA" to "4 to 20 mA".
 - Deactivation of channel 1 via parameter "channel".
- Example B:
 Module 9:
 Changing the baudrate from 500000 bps to 71000 bps.

Example A:

Module 0:
 The parameter of the module (1. slot in the station) can be accessed via registers 0xB000 to 0xB01F.

- 1 Changing the measurement range for channel 0 from "0 to 20 mA" to "4 to 20 mA".
 The module shows the following parameter data structure (1 byte of parameters per channel):

Table 67: Module parameters XN-2AI-I(0/4...20MA)	Byte	Bit	Parameter	Value
A default-setting	0/1	0	Current mode	0 = 0..20mA A
		1		1 = 4..20mA
	1	Value representation	0 = Integer (15bit + sign) A	
			1 = 12bit (left-justified)	
	2	Diagnosis	0 = release A	
			1 = block	
	3	Channel	0 = activate A	
			1 = deactivate	

6 Application example: Modbus TCP

6.4 Parameterization of modules

Thus, register 0xB000, byte 0, bit 0 has to be set.
Function Code 06, "Write Single Register":

Figure 61:
Parameterization
of XN-2AI-
I(0/4...20MA)

A register-no.
B register-value

N°	Date (ms)	Type	Frame
1	0,00	Req	00 18 00 00 00 06 FF 06 B0 00 00 01
2	2,04	Resp	00 18 00 00 00 06 FF 06 B0 00 00 01

2 Deactivation of channel 1 via parameter "channel".

The structure of the module's parameter data can be found in Table 67: Module parameters XN-2AI-I(0/4...20MA), Page 129.

Thus, bit 3 in byte 1 in register 0xB000, Byte 1, Bit 3 has to be set.
Function Code 06, "Write Single Register":

Figure 62:
Parameteriza-
tion
(XN-2AI-I
(0/4...20MA)

A register-no.
B register-value

N°	Date (ms)	Type	Frame
1	0,00	Req	00 18 00 00 00 06 FF 06 B0 00 08 00
2	2,04	Resp	00 18 00 00 00 06 FF 06 B0 00 08 00

Example B:

Module 9:

Changing the baudrate from 500000 bps to 71000 bps.

The parameter of the module (9th slot in the station) can be accessed via registers 0xB120 to 0xB13F.

The module shows the following parameter data structure (4 bytes of parameters in total):

Default: Byte 0: 0x00, Byte 1: 0x00; Byte 2: 0x01; Byte 3: 0x19

→ Register 0x0120 = 0000; Register 0x0121 = 1901

Table 68:
Module
parameters
XN-1SSI

A Default-
settings

Byte	Bit	Parameter name	Value, meaning
0	4 to 0	reserved	
	5	Encoder data cable test	0 = activate A – ZERO test of data cable.
			0 = deactivate – After the last valid bit, a ZERO test of the data cable is not carried out.
7,6	reserved		
1	3 to 0	Number of invalid bits (LSB)	0000 to 1111: Number of invalid bits on the LSB side of the position value supplied by the SSI encoder. The meaningful word width of the position value transferred to the module bus master is as follows: SSI_FRAME_LEN -INVALID_BITS_MSB - INVALID_ BITS_LSB. The invalid bits on the LSB side are removed by shifting the position value to the right, starting with the LSB.(Default 0 bit = 0x0). INVALID_BITS_MSB +INVALID_BITS_LSB must always be less than SSI_FRAME_LEN.
			000 to 111: Number of invalid bits on the MSB side of the position value supplied by the SSI encoder. The meaningful word width of the position value transferred to the module bus master is as follows: SSI_FRAME_LEN -INVALID_BITS_MSB -INVALID_BITS_LSB. The invalid bits on the MSB side are zeroed by masking the position value. INVALID_BITS_MSB + INVALID_BITS_LSB must always be less than SSI_FRAME_LEN. Default: 0 = 0hex
	7	reserved	

6 Application example: Modbus TCP

6.4 Parameterization of modules

Table 69:
Module
parameters
XN-1SSI

A Default-
settings

Byte	Bit	Parameter name	Value, meaning
2	3 to 0	Data rate	0000 = 1000000 bps
			0001 = 500000 bps A
			0010 = 250000 bps
			0011 = 125000 bps
			0100 = 100000 bps
			0101 = 83000 bps
			0110 = 71000 bps
			0111 = 62500 bps
...	reserved		
7 to 4 reserved			
3	5 to 0	Data frame bits	00000 to 100000 Number of bits of the SSI data frame. SSI_FRAME_LEN must always be greater than INVALID_BITS. Default: 25 = 19hex
			6 reserved
			7 Data format

Thus, for setting the baudrate to "71000 bps", bits 0 to 3, in byte 2 in register 0xB121 have to be set. The value "0110 (0x06) = 71000bps" has to be written into byte 2.

The value 0x1906 is written in register 0xB121:

Byte 2: 0x06 (change in parameters)

Byte 3: 0x19 (default setting)

Figure 63:
Parameteriza-
tion of XN-1SSI

A register-no.

B register-value

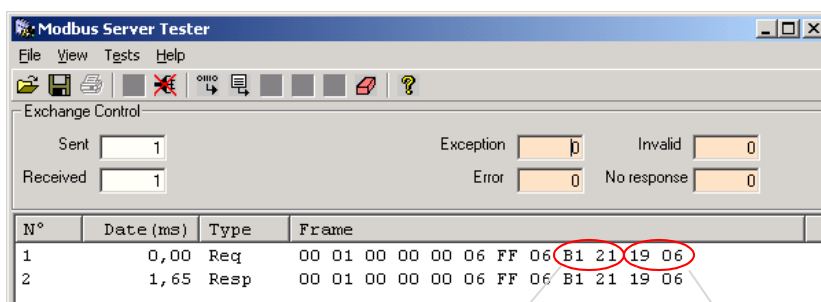

A

B

6.5 Evaluation of module diagnostics

The diagnostic data of the XI/ON modules can be found in registers 0xA000 to 0xA400. For each module in the station, 64 bytes are reserved for diagnosis information.

In addition to that, a group diagnosis (max. 32 modules per station) is displayed. It can be read out either via the packed process data or separately via registers 0x1018 to 0x101A.

The group diagnosis contains one diagnostic bit for each module in the station, which shows, if the respective module sends a diagnostic message or not. The meaning of this diagnostic bit has to be read out from the diagnostic data of the module, registers 0xA000 to 0xA400:

6.5.1 Group diagnosis within the process input data:

Figure 64:
 Group diagnosis in the process data

A group diagnosis

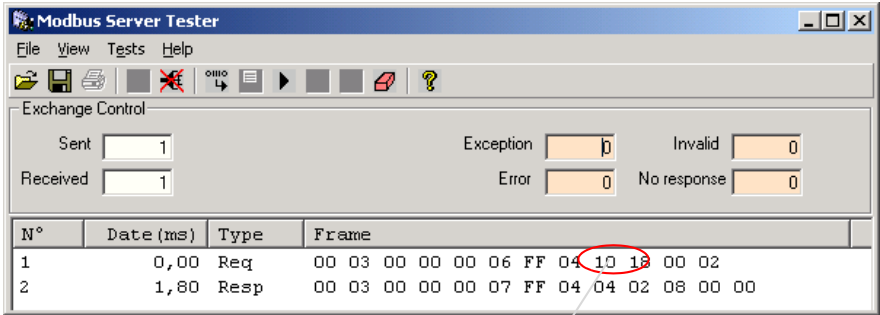

Group diagnosis message: 0x02 0x08

Byte 0 (modules 0 to 7): 0x08

→ Bits 3 is set, which means module 3 sends a diagnostic message:

Table 70:
 Group diagnosis, byte 0,
 Value: 0x08

Bit	7	6	5	4	3	2	1	0
Value	0	0	0	0	1	0	0	0

Byte 1 (modules 8 to 15): 0x02

→ Bit 1 is set, module 9 sends a diagnosis message.

Table 71:
 Group diagnosis, byte 1,
 value 0x02

Bit	7	6	5	4	3	2	1	0
Value	0	0	0	0	0	0	1	0

6 Application example: Modbus TCP

6.5 Evaluation of module diagnostics

6.5.2 Module diagnosis (0xA000 to 0xA400)

For each module, 64 Bytes = 32 registers are reserved for diagnostic messages.

- **Module 3:** XN-2AI-THERMO-PI

The module has 2 bytes of diagnosis data, these are shown in register 0xA060

→ register 0xA060 = 0x0200

→ "open circuit" at channel 1..

Figure 65:
module diagnosis,
module 3

A diagnosis byte
channel 0

B diagnosis byte
channel 1

N°	Date (ms)	Type	Frame
1	0,00	Req	00 06 00 00 00 06 FF 04 A0 60 00 01 A
2	1,50	Resp	00 06 00 00 00 05 FF 04 02 02 00 B

B

Table 72:
XN-2AI-
THERMO-PI

Diagnosis byte	Bit	Diagnosis
n (channel n), n=1,2	0	Measurement value range error: – Threshold: 1 % of the positive measurement range limit value – With type K, N and T sensors, the "Underflow" diagnostic signal is generated on temperatures below -271.6 °C.
	1	Wire break (only in temperature measurements)
	2 to 7	reserved

- **Module 9:** XN-1SSI

The module has 1 byte of diagnosis data, these are shown in register 0xA120

→ register 0xA120 = 0x0002

→ The diagnosis shows an "open circuit" at channel the SSI module, because no SSI-encoder is connected. **I**

Figure 66:
module diagnosis,
module 9

A diagnosis byte
channel 0

B diagnosis byte
channel 1

N°	Date (ms)	Type	Frame
1	0,00	Req	00 08 00 00 00 06 FF 04 A1 20 00 01 A
2	1,69	Resp	00 08 00 00 00 05 FF 04 02 00 02 B

B

Table 73:
XN-1SSI

Diagnosis byte	Bit	Diagnosis
n	0	SSI group diagnostics
	1	Wire break
	2	Sensor value overflow
	3	Sensor value underflow
	4	Parameterization error

6 Application example: Modbus TCP
6.5 Evaluation of module diagnostics

7 Guidelines for station planning

7.1 Module arrangement

7.1.1 Combination possibilities in a XI/ON station

i **Note**
A mixed usage of XNE ECO or XN standard gateways and XNE ECO and XN standard I/O-modules (base modules with tension clamp terminals) is possible without any problems.

i **Note**
The mixed usage of base modules with screw connections and base modules with tension clamp connections requires a further power supply module to be mounted. Thereby, it must be ensured that the base modules are fitted with the same connection technology (screw or tension clamp) as the power supply module.

Figure 67:
Example of a station structure with XNE ECO gateway (here for CANopen), XNE ECO and XN standard I/O modules

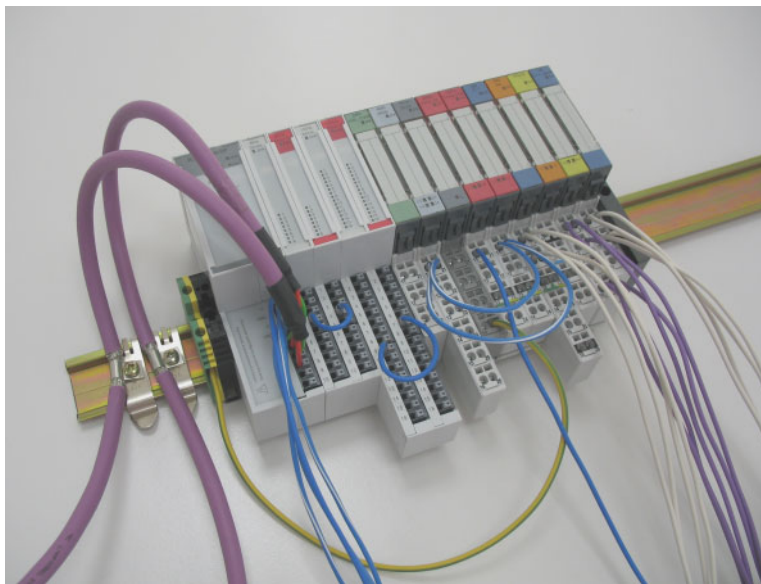

7.1.2 Random module arrangement

The arrangement of the I/O modules within a XI/ON station can basically be chosen at will. Nevertheless, it can be useful with some applications to group certain modules together.

7 Guidelines for station planning

7.1 Module arrangement

7.1.3 Complete planning

The planning of a XI/ON station should be thorough to avoid faults and increase operating reliability.



Attention

If there are more than two empty slots next to one another, the communication is interrupted to all following XI/ON modules.

The power to XI/ON systems is supplied from a common external source. This avoids the occurrence of potential compensating currents within the XI/ON station.

7.2 Maximum station extension

The maximum number of modules within XI/ON station with the gateway XNE-GWBR-2ETH-MB depends on the following factors:

- The station extension may not exceed the maximum number of **32 modules**.
- The maximum permissible number of **192** communication bytes which are transmitted via the module bus from the modules to the gateway must not be exceeded (see below Table 74: Communication bytes and nominal current consumptions of the XI/ON modules from the modul bus IMB, Page 139).
- If the maximum sum of the modules' nominal current consumptions (see below Table 74: Communication bytes and nominal current consumptions of the XI/ON modules from the modul bus IMB, Page 139) right to the gateway (max. sum $\Sigma I_{MB} = 400 \text{ mA}$) is reached, a bus refreshing module has to be used in order to provide the module bus voltage. To the right of the bus refreshing module, the sum of the modules' current consumptions can amount to **1.5 A**.



Attention

Ensure that a sufficient number of bus refreshing and power feeding modules are used if the system is extended to its maximum.



Note

If the system limits are exceeded, the software I/O-ASSISTANT generates an error message when the user activates the menu item [Station] > [Verify].

For the calculation of the maximum system extension, the following table contains an overview about communication bytes as well as about the modules' nominal current consumptions:

Table 74:
Communication bytes and nominal current consumptions of the XI/ON modules from the modul bus I_{MB}

Module	Number of communication bytes	Nominal current consumption from module bus I_{MB}
XN-BR-24VDC-D	2	–
XN-PF-24VDC-D	2	$\leq 28 \text{ mA}$
XN-PF-120/230VAC-D	2	$\leq 25 \text{ mA}$
XN-2DI-24VDC-P	1	$\leq 28 \text{ mA}$
XN-2DI-24VDC-N	1	$\leq 28 \text{ mA}$
XN-2DI-120/230VAC	1	$\leq 28 \text{ mA}$
XN-4DI-24VDC-P	1	$\leq 29 \text{ mA}$
XN-4DI-24VDC-N	1	$\leq 28 \text{ mA}$

7 Guidelines for station planning

7.2 Maximum station extension

Table 74:
Communication
bytes and
nominal current
consumptions
of the XI/ON
modules from
the modul bus
 I_{MB}

Module	Number of communication bytes	Nominal current consumption from module bus I_{MB}
XN-16DI-24VDC-P	2	≤ 45 mA
XN-32DI-24VDC-P	4	≤ 30 mA
XNE-8DI-24VDC-P	1	≤ 15 mA
XNE-16DI-24VDC-P	2	≤ 15 mA
XN-1AI-I(0/4...20MA)	3	≤ 41 mA
XN-2AI-I(0/4...20MA)	5	≤ 35 mA
XN-1AI-U(-10/0...+10VDC)	3	≤ 41 mA
XN-2AI-U(-10/0...+10VDC)	5	≤ 35 mA
XN-2AI-PT/NI-2/3	5	≤ 45 mA
XN-2AI-THERMO-PI	5	≤ 45 mA
XN-4AI-U/I	9	≤ 20 mA
XNE-8AI-U/I-4AI-PT/NI	9	≤ 30 mA
XN-2DO-24VDC-0.5A-P	2	≤ 32 mA
XN-2DO-24VDC-0.5A-N	2	≤ 32 mA
XN-2DO-24VDC-2A-P	2	≤ 33 mA
XN-2DO-120/230VAC-0.5A	2	≤ 35 mA
XN-4DO-24VDC-0.5A-P	2	≤ 30 mA
XN-16DO-24VDC-0.5A-P	3	≤ 120 mA
XN-32DO-24VDC-0.5A-P	5	≤ 30 mA
XNE-8DO-24VDC-0.5A-P	2	≤ 15 mA
XNE-16DO-24VDC-0.5A-P	2	≤ 25 mA
XN-1AO-I(0/4...20MA)	4	≤ 39 mA
XN-2AO-I(0/4...20MA)	7	≤ 40 mA
XN-2AO-U(-10/0...+10VDC)	7	≤ 43 mA
XNE-4AO-U/I	9	≤ 40 mA
XN-2DO-R-NC	1	≤ 28 mA
XN-2DO-R-NO	1	≤ 28 mA

Table 74:
Communication
bytes and
nominal current
consumptions
of the XI/ON
modules from
the modul bus
 I_{MB}

Module	Number of communication bytes	Nominal current consumption from module bus I_{MB}
XN-2DO-R-CO	1	$\cong 28$ mA
XN-1CNT-24VDC	9	$\cong 40$ mA
XNE-2CNT-2PWM	9	$\cong 30$ mA
XN-1RS232	9	$\cong 140$ mA
XN-1RS485/422	9	$\cong 60$ mA
XN-1SSI	9	$\cong 50$ mA
XNE-1SWIRE	9	$\cong 60$ mA

7 Guidelines for station planning

7.3 Power supply

7.3 Power supply

7.3.1 Power supply to the gateway

The gateways XNE-GWBR-2ETH-MB offer an integrated power supply (see also Chapter 4.4.1 Power supply, Page 33).

7.3.2 Module bus refreshing

The number of XI/ON modules, which can be supplied via the internal module bus by the gateway depends on the modules' nominal current consumptions at the module bus (see Table 74: Communication bytes and nominal current consumptions of the XI/ON modules from the modul bus IMB, Page 139).



Attention

The sum of the nominal current consumptions (see Table 74: Communication bytes and nominal current consumptions of the XI/ON modules from the modul bus IMB, Page 139) of the used XI/ON modules may not exceed **400 mA**.

If a bus refreshing module is mounted, the sum of the current consumptions which follow the bus refreshing module must not exceed **1.5 A**.



Note

The bus refreshing modules which are used in a XI/ON station with XNE-GWBR-2ETH-MB have to be combined with the base modules XN-P3T-SBB-B or XN-P4T-SBBC-B (tension clamp) or with the base modules XN-P3S-SBB-B or XN-P4S-SBBC-B (screw terminals).

With the system supply, it must be ensured that the same ground potential and ground connections are used. Compensating currents flow via the module bus if different ground potentials or ground connections are used, which can lead to the destruction of the bus refreshing module.

All bus refreshing modules are connected to one another via the same ground potential.

The power to the module bus is supplied via the connections 11 and 21 on the base module of the bus refreshing modules.

If the power supply from the module bus is not guaranteed or if the maximum station size is exceeded, the software I/O-ASSISTANT generates an error message when the user activates the menu item [Station] > [Verify].

7.3.3 Creating potential groups

Power feeding modules can be used to create potential groups. The potential isolation of potential groups to the left of the respective power supply modules is provided by the base modules.



Note

The system can be supplied with power independent of the potential group formation.

When using I/O modules for 120/230 V AC (XN-2DI-120/230VAC and XN-2DO-120/230VAC-0.5A), it has to be ensured that a potential group is created in conjunction with the power feeding module XN-PF-120/230VAC-D.



Attention

It is not permitted to use modules with 24 V DC and 120/230 V AC field supply in a joint potential group.

7.3.4

C-rail (cross connection)

The C-rail runs through all base modules. The C-rail of the base modules for power supply modules is mechanically separated; thus potentially isolating the adjoining supply groups.

Access to the C-rail is possible with the help of base modules with a C in their designation (for example, XN-S4T-SBCS). The corresponding connection level is indicated on these modules by a thick black line. The black line is continuous on all I/O modules. On power supply modules, the black line is only above the connection 24. This makes clear that the C-rail is separated from the adjoining potential group to its left.

Figure 68:
C-rail front view



7 Guidelines for station planning

7.3 Power supply

Figure 69:
C-rail side view

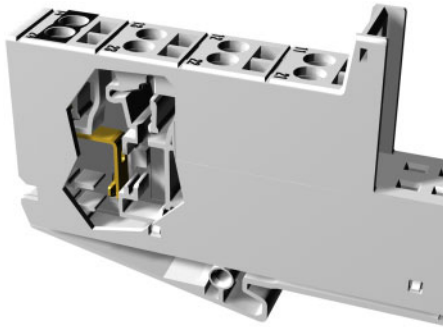

Warning

It is permitted to load the C-rail with a maximum of 24 V. **Not 230 V!**

The C-rail can be used as required by the application, for example, as a protective earth (PE). In this case, the PE connection of each power supply module must be connected to the mounting rail via an additional PE terminal, which is available as an accessory.

The C-rail is not interrupted by the modules of the XNE ECO-products. It is connected through the modules' connection level. But, an access to the C-rail is not possible.



Note

For information about introducing a XI/ON station into a ground reference system, please read Chapter 8, Page 149.

Figure 70:
Using the C-rail
as a protective
earth

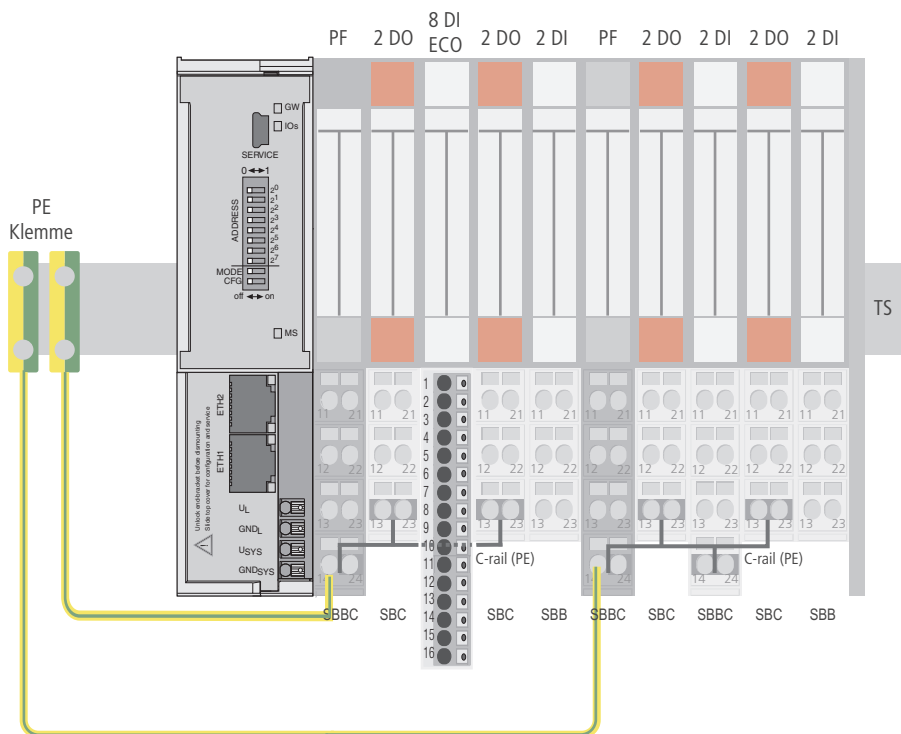

C-rails can be used for a common voltage supply (24 V DC) when relay modules are planned. To accomplish this, the load voltage is connected to a power feeding module with the XN-P4x-SBBC base module. All the following relay modules are then supplied with power via the C-rail.



Attention

When relay modules are planned and the C-rail is used for a common voltage supply, a further power supply module must be used for the potential isolation to the following modules. The C-rail can only again be used as a PE following potential isolation.

Figure 71:
Using the C-rail as protective earth and for the power supply with relay modules

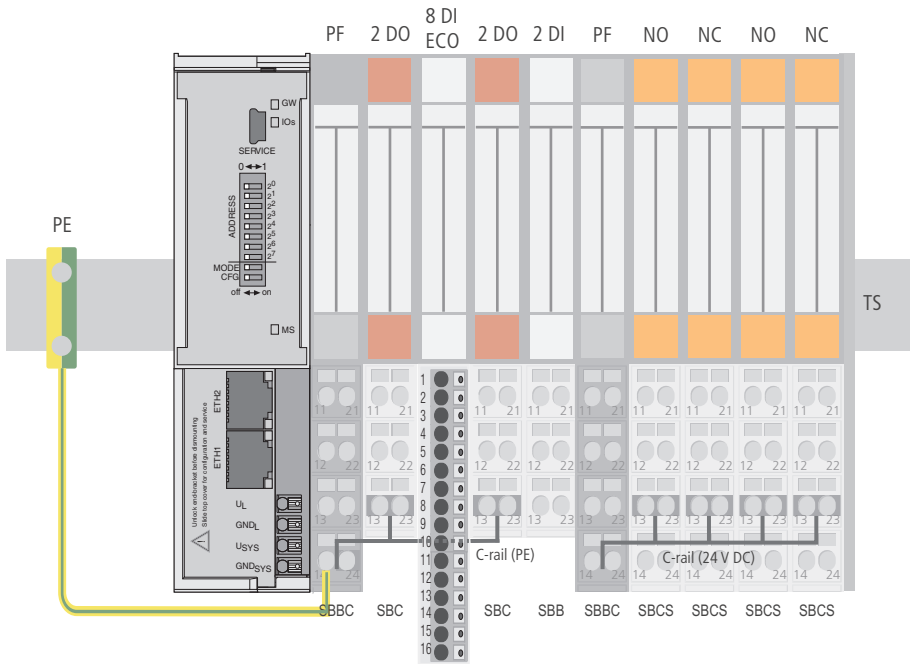

Cross-connecting relay module roots is achieved by the use of jumpers. The corresponding wiring diagram including the jumpers can be found the following manual:

- MN05002010Z
User Manual XI/ON
Digital I/O-Modules, Supply Modules

7.3.5 Direct wiring of relay modules

As well as the options mentioned above, relay modules can be wired directly. In this case, base modules without C-rail connections should be chosen to guarantee the potential isolation to the adjoining modules.

7 Guidelines for station planning

7.4 Protecting the service interface on the gateway

7.4 Protecting the service interface on the gateway

During operation, the label protecting the service interface and the DIP-switches must remain in place due to EMC and ESD requirements.

7.5 Plugging and pulling electronics modules

XI/ON enables the pulling and plugging of XN standard electronics modules without having to disconnect the field wiring. The XI/ON station remains in operation if an electronics module is pulled. The voltage and current supplies as well as the protective earth connections are not interrupted.



Attention

If the field and system supplies remain connected when electronics modules are plugged or pulled, short interruptions to the module bus communications can occur in the XI/ON station. This can lead to undefined statuses of individual inputs and outputs of different modules.

7.6 Extending an existing station



Attention

Please note that extensions to the station (mounting further modules) should be carried out only when the station is in a voltage-free state.

7.7 Firmware download

Firmware can be downloaded via the service or an Ethernet interface on the gateway using the software tool I/O-ASSISTANT. More information is available in the program's online help.



Attention

The station should be disconnected from the field bus when downloading.
Firmware must be downloaded by authorized personnel only.
The field level must be isolated.

7.7.1 DIP-switch position

A firmware download to the gateway using the I/O-ASSISTANT, does not require a special position of the DIP-switches. The described DIP-switch position can be used to "force" the gateway into the download mode. This can be necessary, if the current supply was interrupted during the download.

Table 75:
Position of the
DIP-switches
for firmware
download

Address switch	Position
2^0 - 2^6	0
2^7	1
MODE	1
CFG	1

Figure 72:
Position of the
DIP-switches
for firmware
download

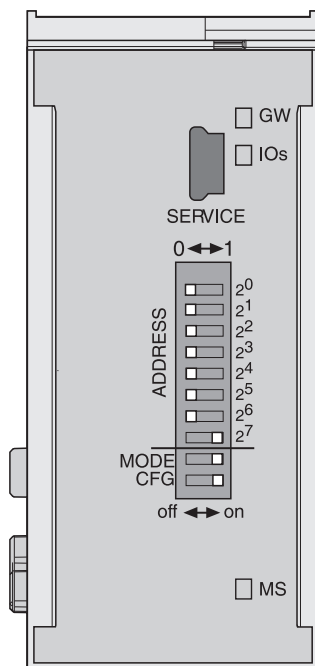

7 Guidelines for station planning

7.7 Firmware download

8 Guidelines for Electrical Installation

8.1 General notes

8.1.1 General

Cables should be grouped together, for example: signal cables, data cables, heavy current cables, power supply cables.

Heavy current cables and signal or data cables should always be routed in separate cable ducts or bundles. Signal and data cables must always be routed as close as possible to ground potential surfaces (for example support bars, cabinet sides etc.).

8.1.2 Cable routing

Correct cable routing prevents or suppresses the reciprocal influencing of parallel routed cables.

Cable routing inside and outside of cabinets

To ensure EMC-compatible cable routing, the cables should be grouped as follows:

Various types of cables within the groups can be routed together in bundles or in cable ducts.

Group 1:

- shielded bus and data cables
- shielded analog cables
- unshielded cables for DC voltage ≤ 60 V
- unshielded cables for AC voltage ≤ 25 V

Group 2:

- unshielded cables for DC voltage > 60 V and ≤ 400 V
- unshielded cables for AC voltage > 25 V and ≤ 400 V

Group 3:

- unshielded cables for DC and AC voltages > 400 V

The following group combination can be routed only in separate bundles or separate cable ducts (no minimum distance apart):

- **Group 1/Group 2**

The group combinations:

- **Group 1/Group 3 and Group 2/Group 3**

must be routed in separate cable ducts with a minimum distance of 10 cm apart. This is equally valid for inside buildings as well as for inside and outside of switchgear cabinets.

8 Guidelines for Electrical Installation

8.1 General notes

Cable routing outside buildings

Outside of buildings, cables should be routed in closed (where possible), cage-type cable ducts made of metal. The cable duct joints must be electrically connected and the cable ducts must be earthed.



Warning

Observe all valid guidelines concerning internal and external lightning protection and grounding specifications when routing cables outside of buildings.

8.1.3

Lightning protection

The cables must be routed in double-grounded metal piping or in reinforced concrete cable ducts.

Signal cables must be protected against overvoltage by varistors or inert-gas filled overvoltage arrestors. Varistors and overvoltage arrestors must be installed at the point where the cables enter the building.

8.1.4

Transmission media

For a communication via Ethernet, different transmission media can be used:

- coaxial cable
 - 10Base2 (thin koax),
 - 10Base5 (thick koax, yellow cable)
- optical fibre (10BaseF)
- twisted two-wire cable (10BaseT) with shielding (STP) or without shielding (UTP).

8.2 Potential relationships

8.2.1 General

The potential relationship of a Ethernet system realized with XI/ON modules is characterized by the following:

- The system supply of gateway and I/O-modules as well as the field supply are realized via one power feed at the gateway.
- All XI/ON modules (gateway, power feeding and I/O-modules), are connected capacitively via base modules to the mounting rails.

The block diagram shows the arrangement of a typical XI/ON station with the gateway XNE-GWBR-2ETH-MB.

Figure 73:
Block diagram
of a XI/ON sta-
tion with
XNE-GWBR-
2ETH-MB

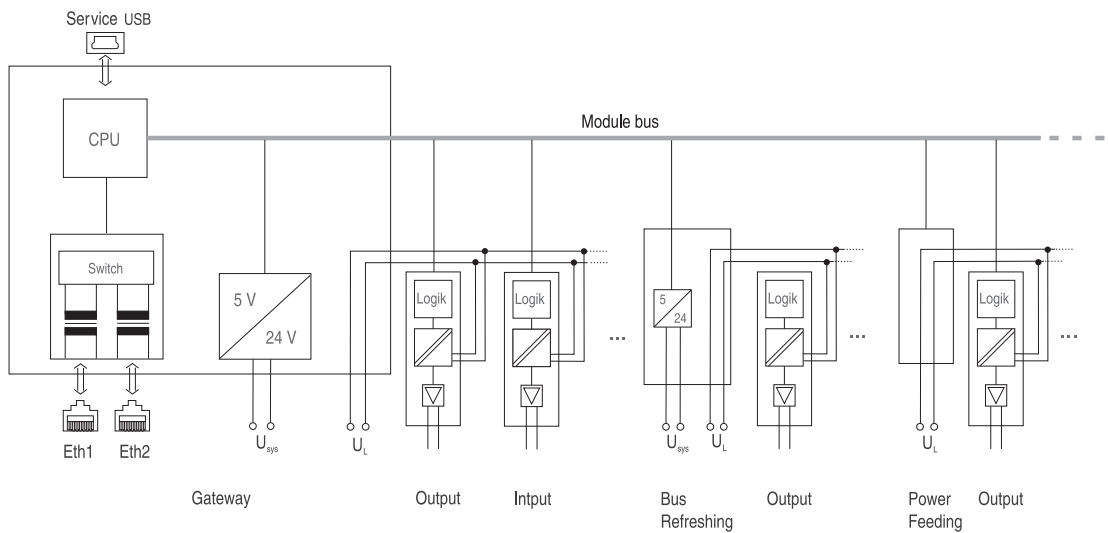

8 Guidelines for Electrical Installation

8.3 Electromagnetic Compatibility (EMC)

8.3 Electromagnetic Compatibility (EMC)

XI/ON products comply in full with the requirements pertaining to EMC regulations.

Nevertheless, an EMC plan should be made before installation. Hereby, all potential electro-mechanical sources of interference should be considered such as galvanic, inductive and capacitive couplings as well as radiation couplings.

8.3.1 Ensuring electromagnetic compatibility

The EMC of XI/ON modules is guaranteed when the following basic rules are adhered to:

- Correct and large surface grounding of inactive metal components.
- Correct shielding of cables and devices.
- Proper cable routing – correct wiring.
- Creation of a standard reference potential and grounding of all electrically operated devices.
- Special EMC measures for special applications.

8.3.2 Grounding of inactive metal components

All inactive metal components (for example: switchgear cabinets, switchgear cabinet doors, supporting bars, mounting plates, tophat rails, etc.) must be connected to one another over a large surface area and with a low impedance (grounding). This guarantees a standardized reference potential area for all control elements and reduces the influence of coupled disturbances.

- In the areas of screw connections, the painted, anodized or isolated metal components must be freed of the isolating layer. Protect the points of contact against rust.
- Connect all free moving groundable components (cabinet doors, separate mounting plates, etc.) by using short bonding straps to large surface areas.
- Avoid the use of aluminum components, as its quick oxidizing properties make it unsuitable for grounding.



Warning

The grounding must never – including cases of error – take on a dangerous touch potential. For this reason, always protect the ground potential with a protective cable.

8.3.3 PE connection

A central connection must be established between ground and PE connection (protective earth).

8.3.4 Earth-free operation

Observe all relevant safety regulations when operating an earthfree system.

8.3.5 Mounting rails

All mounting rails must be mounted onto the mounting plate with a low impedance, over a large surface area, and must be correctly earthed.

Figure 74:
Mounting
options

- A TS 35
- B Mounting rail
- C Mounting plate

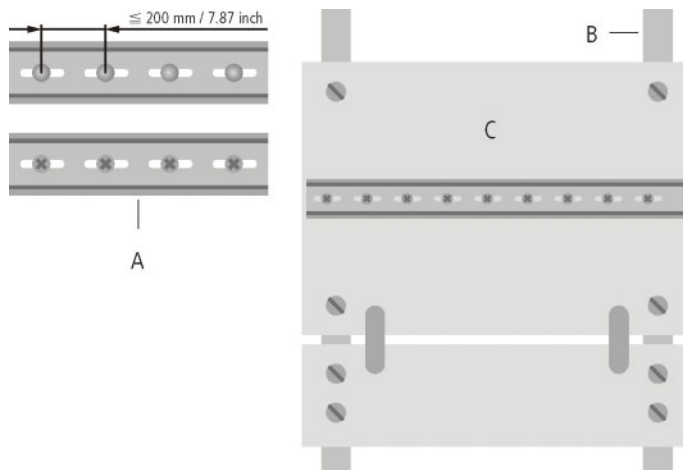

Mount the mounting rails over a large surface area and with a low impedance to the support system using screws or rivets.

Remove the isolating layer from all painted, anodized or isolated metal components at the connection point. Protect the connection point against corrosion (for example with grease; caution: use only suitable grease).

8 Guidelines for Electrical Installation

8.4 Shielding of cables

8.4 Shielding of cables

Shielding is used to prevent interference from voltages and the radiation of interference fields by cables. Therefore, use only shielded cables with shielding braids made from good conducting materials (copper or aluminum) with a minimum degree of coverage of 80 %.

The cable shield should always be connected to both sides of the respective reference potential (if no exception is made, for example, such as high-resistant, symmetrical, analog signal cables). Only then can the cable shield attain the best results possible against electrical and magnetic fields.

A one-sided shield connection merely achieves an isolation against electrical fields.



Warning

When installing, please pay attention to the following...

- the shield should be connected immediately when entering the system,
 - the shield connection to the shield rail should be of low impedance,
 - the stripped cable-ends are to be kept as short as possible,
 - the cable shield is not to be used as a bonding conductor.
-

The insulation of the shielded data-cable should be stripped and connected to the shield rail when the system is not in operation. The connection and securing of the shield should be made using metal shield clamps. The shield clamps must enclose the shielding braid and in so doing create a large surface contact area. The shield rail must have a low impedance (for example, fixing points of 10 to 20 cm apart) and be connected to a reference potential area.

The cable shield should not be severed, but routed further within the system (for example, to the switchgear cabinet), right up to the interface connection.



Note

Should it not be possible to ground the shield on both sides due to switching arrangements or device specific reasons, then it is possible to route the second cable shield side to the local reference potential via a capacitor (short connection distances). If necessary, a varistor or resistor can be connected parallel to the capacitor, to prevent disruptive discharges when interference pulses occur.

A further possibility is a double-shielded cable (galvanically separated), whereby the innermost shield is connected on one side and the outermost shield is connected on both sides.

8.5 Potential compensation

Potential differences can occur between installation components that are in separate areas and these

- are fed by different supplies,
- have double-sided conductor shields which are grounded on different installation components.

A potential-compensation cable must be routed to the potential compensation.



Warning

Never use the shield as a potential compensation.

A potential compensation cable must have the following characteristics:

- Low impedance. In the case of compensation cables that are routed on both sides, the compensation line impedance must be considerably smaller than that of the shield connection (max. 10 % of shield connection impedance).
- Should the length of the compensation cable be less than 200 m, then its cross-section must be at least 16 mm² / 0.025 inch². If the cable length is greater than 200 m, then a cross-section of at least 25 mm² / 0.039 inch² is required.
- The compensation cable must be made of copper or zinc coated steel.
- The compensation cable must be connected to the protective conductor over a large surface area and must be protected against corrosion.
- Compensation cables and data cables should be routed as close together as possible, meaning the enclosed area should be kept as small as possible.

8.5.1 Switching inductive loads

In the case of inductive loads, a protective circuit on the load is recommended.

8.5.2 Protection against Electrostatic Discharge (ESD)



Attention

Electronic modules and base modules are at risk from electrostatic discharge when disassembled. Avoid touching the bus connections with bare fingers as this can lead to ESD damage.

8 Guidelines for Electrical Installation

8.5 Potential compensation

9 Appendix

9.1 Data image of the technology modules

9.1.1 Counter module XN-1CNT-24VDC

Process input data - counter mode

Process input data is data from the connected field device that is transmitted via the XN-1CNT-24VDC module to the PLC. This is transferred in an 8-byte format as follows:

- 4 bytes are used to represent the counter value.
- 1 byte contains the diagnostics data.
- 2 bytes contain status information.

Figure 75:
PZDE counter,
counter mode

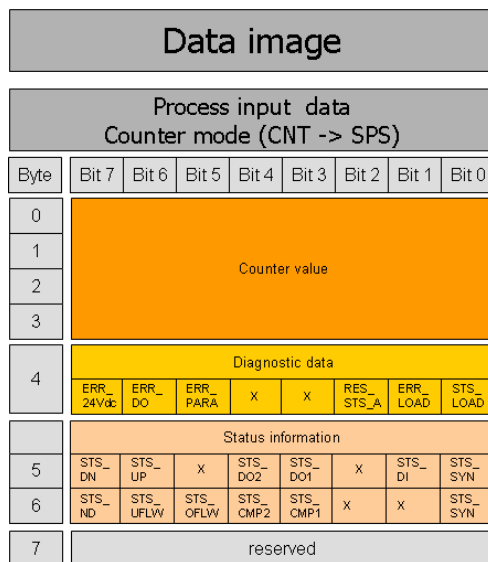

9 Appendix

9.1 Data image of the technology modules

Table 76:
Process input
data - counter
mode of
XN-1CNT-
24VDC

Bits	Value, meaning
ERR_24Vdc	Short-circuit sensor supply This diagnostics information must be acknowledged with the EXT_F_ACK (process output) control bit.
ERR_DO	Short-/open circuit/excess temperature at the output DO1 This diagnostics information must be acknowledged with the EXT_F_ACK (process output) control bit.
ERR_PARA	– 1: There is a parameter error. ERR_PARA is a group diagnostics bit. With the separate diagnostics message bits 3 to 6 describe the parameter errors in more detail. – 0: The parameter definition is correct as per specification.
RES_STS_A	– 1: Resetting of status bits running. The last process output telegram contained: RES_STS = 1. – 0: The last process output telegram contained: RES_STS = 0.
ERR_LOAD	– 1: Error with load function Control bits LOAD_DO_PARAM, LOAD_CMP_VAL2, LOAD_CMP_VAL1, LOAD_PREPARE and LOAD_VAL must not be set at the same time during the transfer. An incorrect value was transferred with the control bits. Example: Values above the upper count limit or below the lower count limit were selected for Load value direct or Load value in preparation.
STS_LOAD	Status of load function Set if the Load function is running.
STS_DN	1: Status direction down.
STS_UP	1: Status direction up.
STS_DO2	The DO2 status bit indicates the status of digital output DO2.
STS_DO1	The DO1 status bit indicates the status of digital output DO1.
STS_DI	The DI status bit indicates the status of digital input DI.
STS_GATE	1: Counting operation running.
STS_ND	Status zero crossing Set on crossing zero in counter range when counting without main direction. This bit must be reset by the RES_STS control bit.
STS_UFLW	Status lower count limit Set if the count value goes below the lower count limit. This bit must be reset by the RES_STS control bit.

Table 76:
Process input
data - counter
mode of
XN-1CNT-
24VDC

Bits	Value, meaning
STS_OFLW	Status upper count limit Set if the counter goes above the upper count limit. This bit must be reset by the RES_STS control bit.
STS_CMP2	Status comparator 2 This status bit indicates a comparison result for comparator 2 if: – The output DO2 is released with CTRL_DO2 = 1. and – a comparison is run via MODE_DO2 = 01, 10 or 11. Otherwise STS_CMP2 simply indicates that the output is or was set. STS_CMP2 is also set if DO2 SET_DO2 = 1 when the output is not released. This bit must be reset by the RES_STS control bit.
STS_CMP1	Status comparator 1 This status bit indicates a comparison result for comparator 1 if: – The output DO1 is released with CTRL_DO1 = 1. and – a comparison is run via MODE_DO1 = 01, 10 or 11. Otherwise STS_CMP1 simply indicates that the output is or was set. It must be acknowledged with RES_STS (process output). The bit is reset immediately if acknowledgement takes place when the output is still set. STS_CMP1 is also set if DO1 SET_DO1 = 1 when the output is not released. This bit must be reset by the RES_STS control bit.
STS_SYN	Status synchronization After synchronization is successfully completed the STS_SYN status bit is set. This bit must be reset by the RES_STS control bit.

9 Appendix

9.1 Data image of the technology modules

Process input data - measurement mode

- 4 bytes contain the measurement value
- 1 byte contains diagnosis information
- 2 bytes contain status messages

Figure 76:
PZDE counter,
measurement
mode

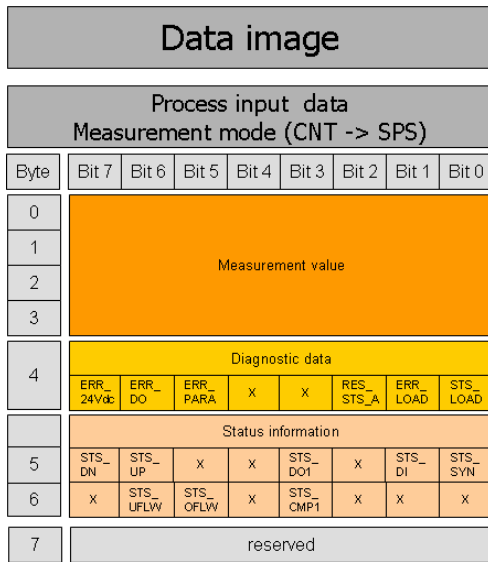

Table 77:
Process input
data - measure-
ment mode of
XN-1CNT-
24VDC

Bits	Value, meaning
ERR_24Vdc	Short-circuit sensor supply This diagnostics information must be acknowledged with the EXTf_ACK (process output) control bit.
ERR_DO	Short-/open circuit/excess temperature at the output DO1
ERR_PARA	– 1: There is a parameter error. ERR_PARA is a group diagnostics bit. With the separate diagnostics message bits 3 to 6 describe the parameter errors in more detail. – 0: The parameter definition is correct as per specification.
RES_STS_A	– 1: Resetting of status bits running. The last process output telegram contained: RES_STS = 1. – 0: The last process output telegram contained: RES_STS = 0.

Table 77:
Process input
data - measure-
ment mode of
XN-1CNT-
24VDC

Bits	Value, meaning
ERR_LOAD	<p>1: Error with load function The control bits LOAD_UPLIMIT and LOAD_LOLIMIT must not be set simultaneously during the transfer. The value of LOAD_UPLIMIT and LOAD_LOLIMIT was selected outside of the permissible range. Permissible values for LOAD_LOLIMIT: 0 to 199 999 999 x10⁻³ Hz 0 to 24 999 999 x 10⁻³ rpm 0 to 99 999 999 ms Permissible values for LOAD_UPLIMIT: 1 to 200 000 000 x 10⁻³ Hz 1 to 25 000 000 x 10⁻³ rpm 1 to 100 000 000 ms</p>
STS_LOAD	<p>Status of load function Set if the Load function is running.</p>
STS_DN	<p>Direction status: down. The direction is determined by a signal at the physical input B. The Signal evaluation parameter (A, B): must be set to pulse and direction.</p>
STS_UP	<p>Direction status: up. The direction is determined by a signal at the physical input B. The Signal evaluation parameter (A, B): must be set to pulse and direction.</p>
STS_DO1	<p>The DO1 status bit indicates the status of digital output DO1.</p>
STS_DI	<p>The DI status bit indicates the status of digital input DI.</p>
STS_GATE	<p>1: Measuring operation running.</p>
STS_UFLW	<p>1: The lower measuring limit was undershot. The bit must be reset with RES_STS: 0 → 1.</p>
STS_OFLW	<p>1: The upper measuring limit was exceeded. The bit must be reset with RES_STS: 0 → 1.</p>
STS_CMP1	<p>1: Measuring terminated^ The measured value is updated with every elapsed time interval. The end of a measurement (expiry of the time interval) is indicated with the status bit STS_CMP1. The bit must be reset with RES_STS: 0 → 1.</p>

9 Appendix

9.1 Data image of the technology modules

Process output data - counter mode

The process output data is the data that is output from the PLC via the gateway to the XN-1CNT-24VDC module.

The XI/ON module allows some parameters to be modified during operation.

The other parameters must be changed prior to commissioning.



Note

The current count operation is stopped if parameters are changed during operation.



Note

The parameters modified via the process output data are not retentive. The commissioning after a power failure is based on the parameter data of the configuration tool or default configuration.

The data is transferred in 8 byte format:

- Four bytes provide the parameter values for "Load direct", "Load in preparation", "Reference value 1", "Reference value 2" or "Behavior of the digital outputs".
- Two control bytes contain the control functions for transferring the parameter values, for starting/stopping the measurement, for acknowledging errors and for resetting the status bit.

Structure of the data bytes with

- "Load value direct"
- "Load value in preparation",
- "Reference value 1" or
- "Reference value 2"

Figure 77:
Structure of the data bytes with "Load value direct", "Load value in preparation", "Reference value 1" or "Reference value 2"

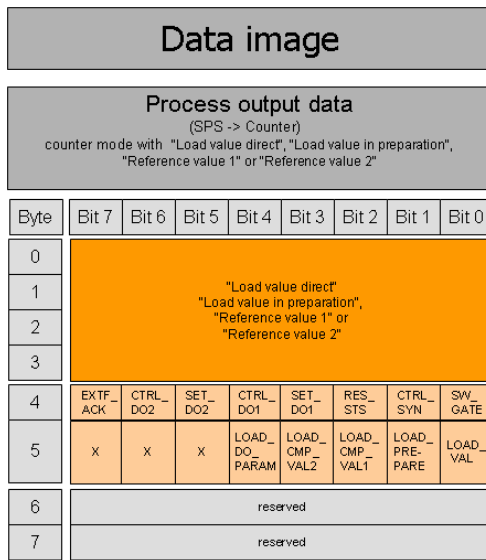

Structure of the data bytes with "Function and behavior of DO1/DO2"

Figure 78:
Structure of the data bytes with "Function and behavior of DO1/DO2"

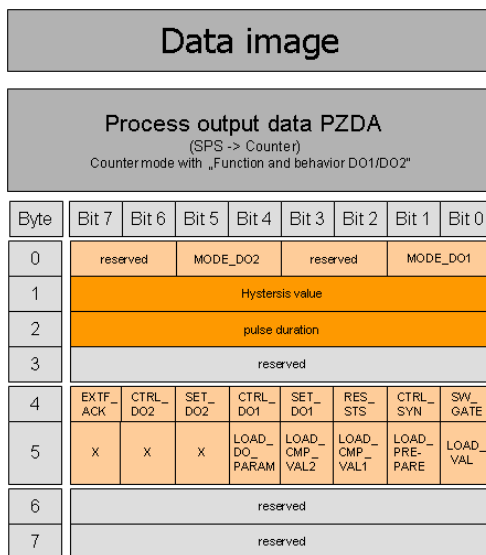

9 Appendix

9.1 Data image of the technology modules

Table 78:
Process output
data - counter
mode of
XN-1CNT-
24VDC

Control bit	Value, meaning
<p>A Unlike the physical digital output DO1, output DO2 is only a data value that is indicated with the data bit STS_DO2 of the process input.</p>	<p>MODE_DO2</p> <p>Only valid if LOAD_DO_PARAM: "0" → "1". The virtual A output DO2 can show the status of the data bit SET_DO2 or comparison results if CTRL_DO2 = 1. MODE_DO2 defines which function DO2 is to accept: – 00: The output DO2 shows the status of the control bit SET_DO2. This must be released with CTRL_DO2 = 1. – 01: Output DO2 indicates: Counter status \geq reference value 2 – 10: Output DO2 indicates: Counter status \leq reference value 2 – 11: Output DO2 indicates: Counter status = reference value 2 A pulse is generated for indicating equal values. The pulse duration is defined by byte 2 of this process output.</p>
	<p>MODE_DO1</p> <p>Only valid if LOAD_DO_PARAM: "0" → "1". The physical output DO1 can show the status of the data bit SET_DO1 or comparison results if CTRL_DO1 = 1. MODE_DO1 defines which function DO1 is to accept: – 00: The output DO1 shows the status of the control bit SET_DO1. This must be released with CTRL_DO1 = 1. – 01: Output DO1 indicates: Counter status \geq reference value 1 – 10: Output DO1 indicates: Counter status \leq reference value 1 – 11: Output DO1 indicates: Counter status = reference value 1 A pulse is generated for indicating equal values. The pulse duration is defined by byte 2 of this process output.</p>
Hysteresis value	<p>(0 to 255)</p> <p>The reference value 1/2 can be assigned a hysteresis value in order to generate a response at DO1/DO2 with hysteresis. This will prevent the excessive on and off switching of DO1/DO2 if the count value fluctuates too quickly around the reference value.</p>
Pulse duration	<p>(0 to 255) unit: ms</p> <p>If the DO1/DO2 outputs are set to indicate counter status = reference value 1/2, a longer pulse is sometimes required to indicate equal values.</p>
EXTF_ACK	<p>Error acknowledgement</p> <p>The error bits must be acknowledged with the control bit EXTF_ACK after the cause of the fault has been rectified. This control bit must then be reset again. Any new error messages are not set while the EXTF_ACK control bit is set!</p>

Table 78:
Process output
data - counter
mode of
XN-1CNT-
24VDC

Control bit	Value, meaning
CTRL_DO2	0: The virtual A output DO2 is blocked.
	1: The virtual A output DO2 is released.
SET_DO2	If CTRL_DO2 = 1 and the virtual A output DO2 is set to indicate the value SET_DO2, DO2 can be set and reset directly with SET_DO2. DO2 can be set for this function via the process output (MODE_DO2 = 00 and LOAD_DO_PARAM "0" → "1"). The output DO2 can also be set before commissioning via the separate parameter data. The default setting for DO2 is to indicate the status of SET_DO2.
CTRL_DO1	0: The output DO1 is blocked.
	1: The output DO1 is released.
SET_DO1	If CTRL_DO1 = 1 and the physical output DO1 is set to indicate the value SET_DO1, DO1 can be set and reset directly with SET_DO1. DO1 can be set for this function via the process output (MODE_DO1 = 00 and LOAD_DO_PARAM "0" → "1"). The output DO2 can also be set before commissioning via the separate parameter data. The default setting for DO1 is to display the value of SET_DO1.
RES_STS	"0" → "1" Initiate resetting of status bits. Status bits STS_ND, STS_UFLW, STS_OFLW, STS_CMP2, STS_CMP1, STS_SYN (process input) are reset. Bit RES_STS_A = 1 (process input) acknowledges that the reset command has been received. RES_STS can now be reset to 0.
CTRL_SYN	Release synchronization 1: "0" → "1" (rising edge) at the physical DI input enables the counter value to be set (synchronized) once/periodically to the load value.
SW_GATE	"0" → "1": Counting is started (release). "1" → "0": Counting is stopped. The starting and stopping of the counting operation with a data bit is implemented with a so-called "SW gate". The HW gate is also provided in addition for stopping and starting the counting operation via the DI hardware input. If this function is configured a positive signal must be present at this input in order to activate the SW gate (AND logic operation).
LOAD_DO_PARAM	Parameter definition of the DO1 physical output and the virtual A DO2 output "0" → "1": DO1 and DO2 can indicate the status of data bit SET_DO1 and SET_DO2 or comparison results. The latest telegram (MODE_DO1 and MODE_DO2) indicates the function required for DO1 and DO2.

9 Appendix

9.1 Data image of the technology modules

Table 78:
Process output
data - counter
mode of
XN-1CNT-
24VDC

Control bit	Value, meaning
LOAD_ CMP_VAL2	Parameter definition of reference value 2 "0" → "1": The value in bytes 0 to 3 is accepted as a reference value 2.
LOAD_ CMP_VAL1	Parameter definition of reference value 1 "0" → "1": The value in bytes 0 to 3 is accepted as a reference value 1.
LOAD_ PREPARE	Parameter definition of Load counter in preparation "0" → "1": The value in bytes 0 to 3 is accepted as the new load value.
LOAD_VAL	Parameter definition of Load counter direct "0" → "1": The value in bytes 0 to 3 is accepted directly as the new count value.

Process output data - measurement mode

The data is transferred in 8 byte format:

- Four bytes represent the parameter values for Lower limit or Upper limit, Function of DO1 or Integration time.
- Two control bytes contain the control functions for transferring the parameter values, for starting/stopping the measurement, for acknowledging errors and for resetting the status bit.

Structure of the data bytes with "Function of DO1" set

Figure 79:
Structure of the data bytes with "Function of DO1" set

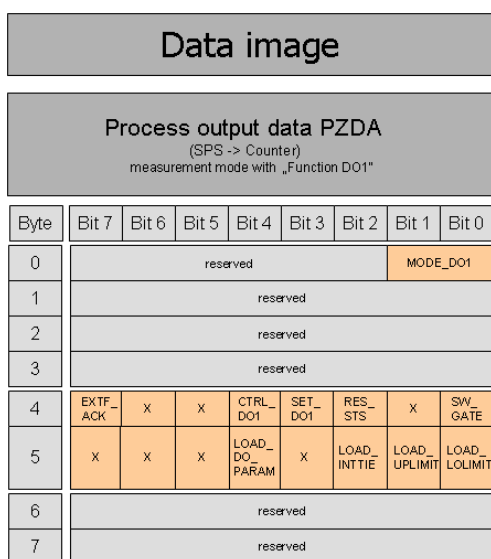

Structure of the data bytes with "Lower limit" or "Upper limit" set

Figure 80:
Structure of the data bytes with "Lower limit" or "Upper limit" set

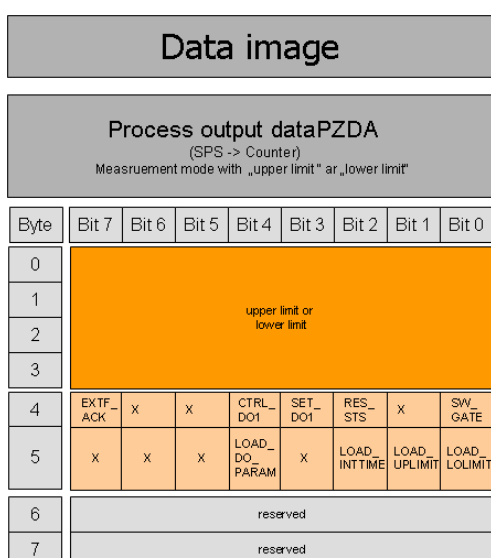

9 Appendix

9.1 Data image of the technology modules

Structure of the data bytes with "Integration time set"

Figure 81:
Structure of the data bytes with "Integration time set"

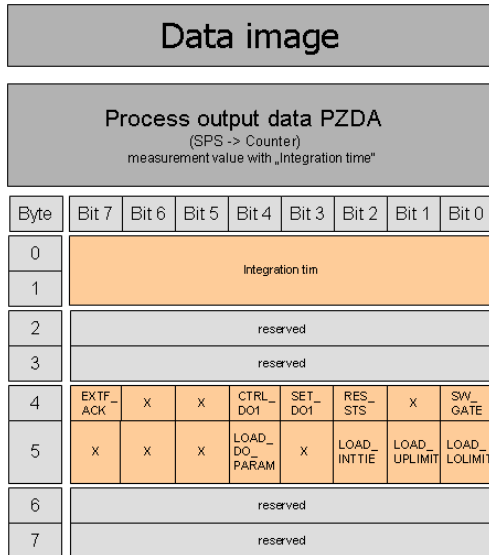

Table 79:
Process output data - measurement mode of XN-1CNT-24VDC

Control bit	Value, meaning
-------------	----------------

EXTF_ACK	Error acknowledgement The ERR_DO or ERR_24Vdc error bits must be acknowledged with the control bit EXTF_ACK after the cause of the fault has been rectified. This control bit must then be reset again. Any new error messages are not set while the EXTF_ACK control bit is set!
CTRL_DO1	- 0: The output DO1 is blocked. - 1: The output DO1 is released.
SET_DO1	If CTRL_DO1 = 1 and the physical output DO1 is configured for indicating the value SET_DO1, DO1 can be set and reset directly with SET_DO1. DO1 can be set for this function via the process output (MODE_DO1 = 00 and LOAD_DO_PARAM 0 → 1). The output DO1 can also be set before commissioning via the separate parameter data. The default setting for DO1 is to display the value of SET_DO1.
RES_STS	0 → 1: Initiate resetting of status bits. The STS_UFLW, STS_OFLW and STS_CMP1 (process input) status bits are reset. Bit RES_STS_A = 1 (process input) acknowledges that the reset command has been received. RES_STS can now be reset to 0.
SW_GATE	0 → 1: Measuring is started (software release). 1 → 0: Measuring is stopped.

Table 79:
Process output
data - measure-
ment mode of
XN-1CNT-
24VDC

Control bit	Value, meaning
LOAD_DO_PARAM	Parameter setting of the physical output DO1 0 → 1: DO1 can indicate the status of different data bits as a signal. The current telegram (byte 0) determines the data bits to which DO1 is to refer.
LOAD_INTTIME	Parameter setting of the Integration time 0 → 1: Bytes 0 to 1 of this process output represent a factor for forming the Integration time for frequency measurement and for determining the rotational speed. The integration time can be adjusted between 10 ms and 10 s in 10 ms increments and is produced by multiplying the factor x 10 ms. With period duration measurement, this factor determines the number of periods measured in order to calculate a mean value. A factor 1 to 1000 (1hex to 3E8hex) is permissible.
LOAD_UPLIMIT	Parameter setting of the upper measuring limit 0 → 1: The value in bytes 0 to 3 is accepted directly as the new upper measuring limit. LOAD_UPLIMIT: 1 to 200 000 000 x 10 ⁻³ Hz 1 to 25 000 000 x 10 ⁻³ rpm 1 to 100 000 000 ms
LOAD_LOPLIMIT	Parameter setting of the lower measuring limit 0 A 1: The value in bytes 0 to 3 is accepted directly as the new lower measuring limit. LOAD_LOLIMIT: 0 to 199 999 999 x 10 ⁻³ Hz 0 to 24 999 999 x 10 ⁻³ rpm 0 to 99 999 999 ms
MODE_DO1	MODE_DO1 is only valid if LOAD_DO_PARAM: 0 → 1. The physical output DO1 can show the status of the data bit SET_DO1 or comparison results if CTRL_DO1 = 1. MODE_DO1 defines which function DO1 is to accept: – 00 : The output DO1 indicates the status of the control bit SET_DO1. – 01 : The output DO1 indicates a measurement outside of the limits, i.e. above the upper measuring limit or below the lower measuring limit. STS_OFLW = 1 or STS_UFLW = 1 (process input). – 10 : Output DO1 indicates a value below the lower measuring limit. STS_UFLW = 1 (process input) – 11 : Output DO1 indicates a value above the upper measuring limit. STS_OFLW = 1 (process input)

9 Appendix

9.1 Data image of the technology modules

9.1.2 Counter module XNE-2CNT-2PWM

Process input data / check-back interface

	Byte	Bit 7	Bit 6	Bit 5	Bit 4	Bit 3	Bit 2	Bit 1	Bit 0
CNTx	0	A1	B1	Z1	STS_CNT1_DIR	STS_CNT1_LOGMSG	STS_CNT1_SFKT_EN	STS_CNT1_RUN	STS_CNT1_GENERAL_EN
	1	MSG_CNT1_SW_LR	MSG_CNT1_SFKT	MSG_CNT1_FQE	MSG_CNT1_ND	MSG_CNT1_OFLW	MSG_CNT1_UFLW	MSG_CNT1_CMP1	MSG_CNT1_CMP0
	2	A2	B2	Z2	STS_CNT2_DIR	STS_CNT2_LOGMSG	STS_CNT2_SFKT_EN	STS_CNT2_RUN	STS_CNT2_GENERAL_EN
	3	MSG_CNT2_SW_LR	MSG_CNT2_SFKT	MSG_CNT2_FQE	MSG_CNT2_ND	MSG_CNT2_OFLW	MSG_CNT2_UFLW	MSG_CNT2_CMP1	MSG_CNT2_CMP0
PWMx	4	STS_PWM1_LOGMSG	STS_PWM1_SFKT_EN	STS_PWM1_RUN	STS_PWM1_GENERAL_EN	MSG_PWM1_DO_ERR	MSG_PWM1_SFKT	MSG_PWM1_NDDC	MSG_PWM1_SW_LR
	5	STS_PWM2_LOGMSG	STS_PWM2_SFKT_EN	STS_PWM2_RUN	STS_PWM2_GENERAL_EN	MSG_PWM2_DO_ERR	MSG_PWM2_SFKT	MSG_PWM2_NDDC	MSG_PWM2_SW_LR
Communication	6	REG_WVR_ACCEPT	REG_WR_AKN	REG_RD_ABORT	STS_CONFIG_ERR	STS_DBP2	D2	STS_DBP1	D1
	7	reserved	REG_RD_ADR						
User data	8	REG_RD_DATA, Byte 0							
							
	11	REG_RD_DATA, Byte 3							
	12	AUX_REG1_RD_DATA, Byte 0							
							
	15	AUX_REG1_RD_DATA, Byte 3							
	16	AUX_REG2_RD_DATA, Byte 0							
							
	19	AUX_REG2_RD_DATA, Byte 3							
	20	AUX_REG3_RD_DATA, Byte 0							
							
23	AUX_REG3_RD_DATA, Byte 3								



Note

STATUS- (STS) or error messages (ERR) are volatile messages which are reset due to a change in status or due to the elimination of an error. In contrast, MSG describes a **non volatile** flag, which is set due to a certain event. It has to be reset.

Table 80:
Process input
data / check-
back interface of
XNE-2CNT-
2PWM

	Byte	Bit	Value	Meaning	
CNTx					
0,2	STS_CNTx_GENERAL_EN		0	Function (CNTx) disabled	
			1	Function enabled	
	STS_CNTx_RUN		0	CNTx Counter not ready to count	
			1	CNTx Counter ready to count	
	STS_CNTx_SFKT_EN		0	Special function of Z disabled for CNTx	
			1	Special function of Z enabled for CNTx	
	STS_CNTx_LOGMSG		0	Curent status of MSG bits	
			1	Status of MSG bits are frozen	
	STS_CNTx_DIR		0	CNTx Counter counts down.	
			1	CNTx Counter counts up.	
	Ax, Bx, Zx		0	Digital input is LOW.	
			1	Digital input is HIGH.	
	1,3	MSG_CNTx_CMP0		0	No message active that reports that the compare value CMP0 has been reached.
				1	The counter CNTx reports that the compare value CMP0 was reached.
MSG_CNTx_CMP1			0	No message active that reports that the compare value CMP1 has been reached.	
			1	The counter CNTx reports that the compare value CMP1 was reached.	
MSG_CNTx_UFLW			0	No message active that reports that the lower count limit has been reached.	
			1	The counter CNTx reports the lower count limit was reached.	
MSG_CNTx_OFLW			0	No message active that reports that the upper count limit has been reached.	
			1	The counter CNTx reports the upper count limit was reached.	
MSG_CNTx_ND			0	No message active that reports a zero crossing.	
			1	The counter CNTx reports a zero crossing.	

9 Appendix

9.1 Data image of the technology modules

Table 80:
Process input
data / check-
back interface of
XNE-2CNT-
2PWM

Byte	Bit	Value	Meaning
1,3	MSG_CNTx_FQE	0	No error occurred in frequency or period duration measurement.
		1	The counter CNTx reports an error in frequency / period duration measurement. Possible error causes: Max. length of the no-pulse period reached. The value cannot be displayed correctly in the register for the "pulses per integration time" REG_CNTx_IPI due to a multiplier which has been set too high in register REG_CNTx_MUL.
	MSG_CNTx_SFKT	0	The event according to there parameterized special function CNT1_SFKT_DISABLE did not occur .
		1	The event according to there parameterized special function CNT1_SFKT_DISABLE occurred.
	MSG_CNTx_SW_LR	0	The function Latch-Retrigger has not been activated.
		1	The function Latch-Retrigger has been activated via bit CNTx_SW_LR = 1.
PWMx			
4,5	MSG_PWM1x_SW_LR	0	The function Latch-Retrigger has not been activated.
		1	The function Latch-Retrigger has been activated via bit PWMx_SW_LR = 1.
	MSG_PWMx_NDDC	0	No message active that reports a zero crossing of the PWMx.
		1	The counter PWMx reports a zero crossing.
	MSG_PWMx_SFKT	0	The event according to there parameterized special function PWMx_SFKT_DISABLE did not occur .
		1	The event according to there parameterized special function PWMx_SFKT_DISABLE occurred.

Table 80:
Process input
data / check-
back interface of
XNE-2CNT-
2PWM

Byte	Bit	Value	Meaning
4,5	MSG_PWMx_DO_ERR	0	No error message from outputs Px / Dx.
		1	One of the outputs Px (Px_DIAG) or Dx (Dx_DIAG) of the corresponding PWMx-channel sent an error.
	STS_PWMx_GENERAL_EN	0	Function (PWMx) disabled
		1	Function enabled, with a change from 0 → 1 the channel is set to the initial state
	STS_PWMx_RUN	0	PWMx-signal output not active
		1	PWMx-signal output active
	STS_PWMx_SFKT_EN	0	Special function of Z disabled for PWMx
		1	Special function of Z enabled for PWMx
	STS_PWMx_LOGMSG	0	Current status of MSG bits
		1	Status of MSG bits are frozen
Communication			
6	Dx	0	Digital input is LOW
		1	Digital input is HIGH
	STS_DBPx	0	Status of the information defined through DBPx STS MODE.
		1	
	STS_CONFIG_ERR	0	The present configuration is OK.
		1	In REG_CONFIG_ERR an error is reported
	REG_RD_ABORT	0	The reading of the register defined in REG_RD_ADR has been accepted and executed. The content of the register can be found in the user data (REG_RD_DATA).
		1	Reading of the register defined in REG_RD_ADR has not been accepted. The register content (REG_RD_DATA) is zero.
	REG_WR_AKN	0	A change of register contents had been assigned through a process output.
		1	No change of register contents through a process output. (Write access REG_WR to the register interface is only possible, if this bit was zero before; handshake for data transfer to the registers).

9 Appendix

9.1 Data image of the technology modules

Table 80:
Process input
data / check-
back interface of
XNE-2CNT-
2PWM

Byte	Bit	Value	Meaning
6	REG_WR_ACCEPT	0	Writing the user data from the control interface to the register addressed with REG_WR_ADR in the control interface could not be done.
		1	Writing the user data from the control interface to the register addressed with REG_WR_ADR in the control interface was successful.
7	REG_RD_ADR	0...127	Address of the input register of which the content is shown in the user data (REG_RD_DATA) in the check-back interface if REG_RD_ABORT = 0.
User data			
8 ... 11	REG_RD_DATA	0...2 ³² -1	Content of the register of which the address is transferred with the process input data (REG_RD_ADR) if REG_RD_ABORT = 0. If not, REG_RD_DATA = 0.
12 ... 23	AUX_REGx_RD_DATA	0...2 ³² -1	Value, which is read from the register with the address defined in the parameterization in ADR_AUX_REGx_RD_DATA.

Process output data / control interface

		Byte	Bit 7	Bit 6	Bit 5	Bit 4	Bit 3	Bit 2	Bit 1	Bit 0
Control bytes	CNT x	0	reserved	CNT1_SINGLE	CNT1_SW_LR	CNT1_SFKT_DISABLE	reserved	CNT1_LOGMSG	CNT1_ENABLE	CNT1_GENERAL_DISABLE
		1	reserved	CNT2_SINGLE	CNT2_SW_LR	CNT2_SFKT_DISABLE	reserved	CNT2_LOGMSG	CNT2_ENABLE	CNT2_GENERAL_DISABLE
	PWM x	2	reserved	PWM1_SINGLE	PWM1_SW_LR	PWM1_SFKT_DISABLE	reserved	PWM1_LOGMSG	PWM1_ENABLE	PWM1_GENERAL_DISABLE
		3	reserved	PWM2_SINGLE	PWM2_SW_LR	PWM2_SFKT_DISABLE	reserved	PWM2_LOGMSG	PWM2_ENABLE	PWM2_GENERAL_DISABLE
	DOs	4	reserved	reserved	SET_P2	SET_D2	reserved	reserved	SET_P1	SET_D1
Register access		5	REG_WR	reserved	reserved	reserved	reserved	AUX_REG3_WR_EN	AUX_REG2_WR_EN	AUX_REG1_WR_EN
		6	reserved	REG_WR_ADR						
		7	reserved	REG_RD_ADR						
User data		8	REG_WR_DATA, byte 0							
								
		11	REG_WR_DATA, byte 3							
		12	AUX_REG1_WR_DATA, byte 0							
								
		15	AUX_REG1_WR_DATA, byte 3							
		16	AUX_REG2_WR_DATA, byte 0							
								
		19	AUX_REG2_WR_DATA, byte 3							
		20	AUX_REG3_WR_DATA, byte 0							
								
	23	AUX_REG3_WR_DATA, byte 3								

9 Appendix

9.1 Data image of the technology modules

Table 81:
Process output
data / control
interface of
XNE-2CNT-
2PWM

	Byte	Bit	Value	Meaning
Control bytes				
0,1	CNTx_GENERAL_DISABLE		0	Enable function unit CNTx
			1	Disable function unit CNTx generally
	CNTx_ENABLE		0	Not activated
			1	Enable counter CNTx (SW gate) The enable is done either per SW- or per HW gate.
	CNTx_LOGMSG		0	The messages in the MSG-bits (MSG for CNTx) in the Process input / check-back interface are active
			1	With a change from 0 → 1 the MSG data are held and actual incoming messages are stored to register REG_PWMx_LOGMSG. Before switching to REG_CNTx_LOGMSG, this register is set to "0". With a change from 1 → 0, all data from REG_CNTx_LOGMSG are copied to the MSG-bits in the Process input / check-back interface.
	CNT1_SFKT_DISABLE		0	Enable the special function of input Zx depending on the parameterization Mode Zx .
			1	Disable the special function of input Zx.
	CNTx_SW_LR		0	Not activated
			1	A Software (SW) latch retrigger has to be executed at counter CNTx with a change from 0 → 1
	CNTx_SINGLE		0	Continuous enabling of CNTx (Method of counting: periodical counting)
			1	Single enabling of CNTx (Method of counting: single counting)
2,3	PWMx_GENERAL_DISABLE		0	Enable function unit PWMx
			1	Disable function unit PWMx
	PWMx_ENABLE		0	Not activated
			1	Enable output PWMx The enable is done either per SW- or per HW gate.

Table 81:
Process output
data / control
interface of
XNE-2CNT-
2PWM

Byte	Bit	Value	Meaning
2,3	PWMx_LOGMSG	0	The messages in the MSG-bits (MSG for PWMx) in the Process input / check-back interface are active.
		1	With a change from 0 → 1 the MSG data are held and actual incoming messages are stored to register REG_PWMx_LOGMSG. Before switching to REG_PWMx_LOGMSG, this register is set to "0". With a change from 1 → 0, all data from REG_PWMx_LOGMSG are copied to the MSG-bits in the Process input / check-back interface.
	PWMx_SFKT_DISABLE	0	Enable the special function of input Zx depending on the parameterization.
		1	Disable the special function of input Zx depending on the parameterization.
	PWMx_SW_LR	0	Not activated
		1	A latch retrigger has to be executed at counter PWMx with a change from 0 → 1.
	PWMx_SINGLE	0	Continuous enabling of PWM
		1	Single enabling of PWMx
4	SET_ Dx	0	Clear bit Dx
		1	Set bit Dx
	SET_ Px	0	Clear bit Px
		1	Set bit Px
Register access			
5	AUX_REG1_WR_EN ... AUX_REG3_WR_EN	0	Disabling the writing of register data with the register contents in AUX_REGx_WR_DATA. This option avoids an unintentional writing to registers in the Register interface.
		1	Writing of the Register interface with the register contents in AUX_REGx_WR_DATA is enabled.

9 Appendix

9.1 Data image of the technology modules

Table 81:
Process output
data / control
interface of
XNE-2CNT-
2PWM

Byte	Bit	Value	Meaning
5	REG_WR	0	Initial state
		1	Triggering a write command. The register of which the address has been defined with REG_WR_ADR, will be written with data from REG_WR_DATA.
6	REG_WR_ADR	0...127	Address of the register, which has to be written with REG_WR_DATA (→ see below).
7	REG_RD_ADR	0...127	Address of the register, which has to be read. The user data can be found in REG_RD_DATA in the Process input / check-back interface) if RD_ABORT = 0.
User data			
8	REG_WR_DATA, Byte 0	0332 ³² -1	Value which, during a write operation, has to be written to the register selected with REG_WR_ADR (→ see above).
...	...		
11	REG_WR_DATA, Byte 3		
12	AUX_REGx_WR_DATA, Byte 0	0...2 ³² -1	Value which, during a write operation, has to be written to the register defined in (ADR AUX REGx WR DATA) in the parameterization.
...	...		
15	AUX_REGx_WR_DATA, Byte 3		

9.1.3 RSxxx-module

Process input data

Process input data is data from the connected field device that is transmitted via the XN-1RSxxx module to the PLC. The incoming data are stored in the receive-buffer of the XN-1RSxxx module, segmented and transferred to the PLC via the module bus and the gateway.

The transmission is realized in a 8-byte format, structured as follows:

- 1 status byte, used to guarantee error free data-transmission.
- 1 byte diagnostic data
- 6 byte user data

Figure 82:
Data image PLC
input data

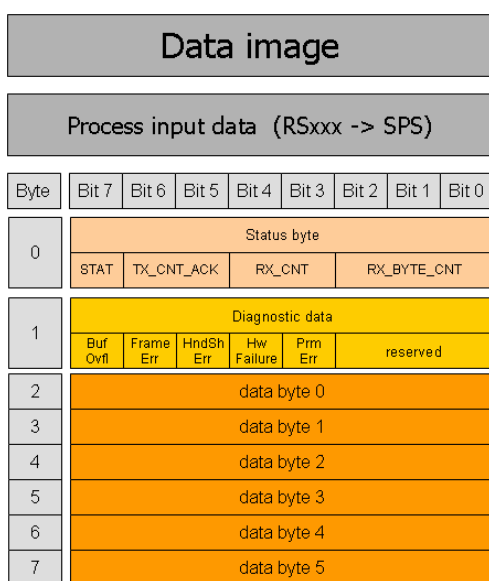

9 Appendix

9.1 Data image of the technology modules

Table 82:
Process input
data of
XN-1RSxxx

Designation	Value	Meaning
BufOvfl; FrameErr; HndShErr; HwFailure; PrmErr	0 - 255	Diagnostic information (correspond to the diagnostic information in the diagnosis telegram). These diagnostics are always displayed and independent to the setting of the parameter "Diagnostics".
STAT	0-1	1: The communication with the data terminal equipment (DTE) is error free 0: The communication with the data terminal equipment (DTE) is disturbed. A diagnosis message is generated if the parameter "Diagnostics" is set to "0/ release". The diagnostic data show the cause of the communication disturbance. The user has to set back this bit in the process output data by using STATRES.
TX_CNT_ACK	0-3	The value TX_CNT_ACK is a copy of the value TX_CNT. TX_CNT has been transmitted together with the last data segment of the process output data. TX_CNT_ACK is an acknowledge for the successful transmission of the data segment with TX_CNT.
RX_CNT	0-3	This value is transferred together with every data segment. The RX_CNT values are sequential: 00->01->10->11->00... (decimal: 0->1->2->3->0...) Errors in this sequence show the loss of data segments.
RX_BYTE_CNT	0-7	Number of the valid bytes in this data segment.

Process output data

Process output data are data which are sent from the PLC via the gateway and the XN-1RSxxx module to a connected field device.

The data received from the PLC are loaded into the 64-byte transmit-buffer in the XN-1RSxxx module.

The transmission is realized in a 8-byte format which is structured as follows:

- 1 control byte, used to guarantee error free data-transmission.
- 1 byte containing signals to flush the transmit- and receive buffer.
- 6 byte user data

Figure 83:
Process output
data

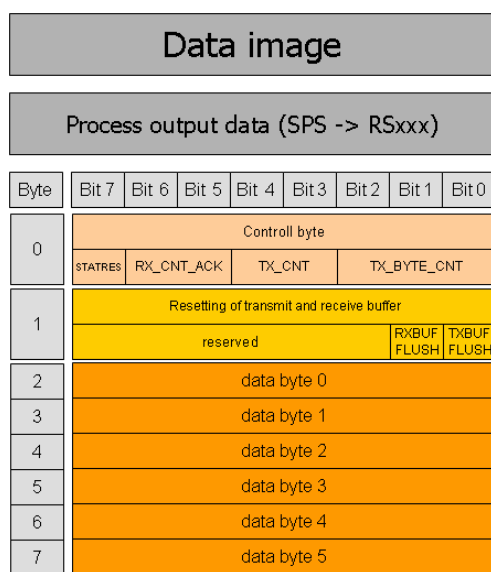

9 Appendix

9.1 Data image of the technology modules

Table 83:
Process output
data of
XN-1RSxxx

Designation	Value	Meaning
STATRES	0–1	<p>This bit is set to reset the STAT bit in the process input data. With the change from 1 to 0 the STAT bit is reset (from 0 to 1).</p> <p>If this bit is 0, all changes in TX_BYTE_CNT, TX_CNT and RX_CNT_ACK are ignored. Flushing the transmit-/ receive-buffer with RXBUF FLUSH/ TXBUF FLUSH is possible.</p> <p>If this bit is 1 or with the change from 0 to 1, the flushing of the transmit-/ receive-buffer with RXBUF FLUSH/ TXBUF FLUSH is not possible.</p>
RXBUF FLUSH	0–1	<p>This bit is used to flush the receive-buffer.</p> <p>If STATRES = 1: The command RXBUF FLUSH = 1 is ignored.</p> <p>If STATRES = 0: RXBUF FLUSH = 1 causes the flushing of the receive-buffer.</p>
TXBUF FLUSH	0–1	<p>This bit is used to flush the transmit-buffer.</p> <p>If STATRES = 1: The command TXBUF FLUSH = 1 is ignored.</p> <p>If STATRES = 0: TXBUF FLUSH = 1 causes the flushing of the transmit-buffer.</p>
RX_CNT_ACK	0–3	<p>The value RX_CNT_ACK is a copy of the value RX_CNT. TX_CNT has been transmitted together with the last data segment of the process input data. TX_CNT_ACK is an acknowledge for the successful transmission of the data segment with RX_CNT.</p>
TX_CNT	0–3	<p>This value is transferred together with every data segment. The TX_CNT values are sequential: 00->01->10->11->00... (decimal: 0->1->2->3->0...)</p> <p>Errors in this sequence show the loss of data segments.</p>
TX_BYTE_CNT	0–7	<p>Number of the valid user data in this data segment. In PROFIBUS-DP, the data segments contain a maximum number of 6 bytes of user data.</p>

9.1.4 SSI-module

Process input data

The field input data is transferred from the connected field device to the XN-1SSI module.

The process input data is the data that is transferred to the PLC from the XN-1SSI via a gateway.

This is transferred in an 8 byte format as follows:

- 4 bytes are used for representing the data that was read from the register with the address stated at REG_RD_ADR.
- When necessary, 1 byte represents the register address of the read data and an acknowledgement that the read operation was successful.
- 1 byte can be used to transfer status messages of the SSI encoder. This byte also contains an acknowledgement that the write operation to the register was successful and indication of an active write operation.
- 1 byte contains the results of comparison operations with the SSI encoder value.
- 1 byte contains messages concerning the communication status between the XN-1SSI module and the SSI encoder, as well as other results of comparison operations.

The following table describes the structure of the 8 x 8 bits of the process input data.

STS (or ERR) contains non-retentive status information, i.e. the bit concerned indicates the actual status.

FLAG describes a retentive flag that is set in the event of a particular event. The bit concerned retains the value until it is reset.

Figure 84:
Process input data

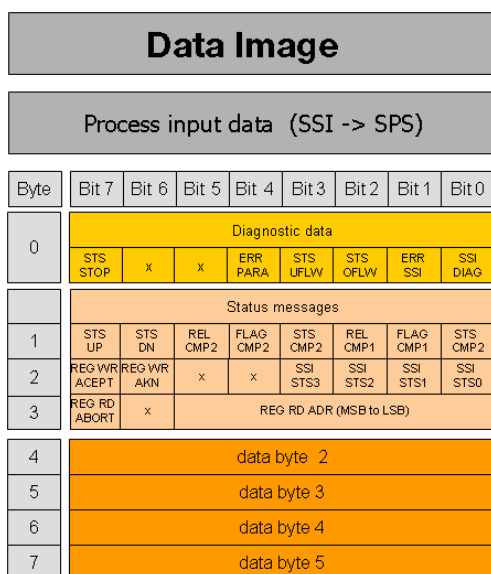

9 Appendix

9.1 Data image of the technology modules

Table 84:
Process input
data of
XN-1SSI

Designation	Value	Meaning
REG_RD_DATA	0... ($2^{32}-1$)	Content of the register to be read if REG_RD_ABORT = 0. If REG_RD_ABORT = 1, then REG_RD_DATA = 0.
REG_RD_ABORT	0	The reading of the register stated at REG_RD_ADR was accepted and executed. The content of the register is located in the user data range (REG_RD_DATA Bytes 0-3).
	1	The reading of the register stated at REG_RD_ADR was not accepted. The user data range (REG_RD_DATA Bytes 0-3) is zero.
REG_RD_ADR	0...63	The reading of the register stated at REG_RD_ADR was not accepted. The user data range (REG_RD_DATA Bytes 0-3) is zero.
REG_WR_ACCEPT	0	The writing of user data for process output to the register with the address stated at REG_WR_ADR in the process output data could not be executed.
	1	The writing of user process output data to the register with the address stated at REG_WR_ADR in the process output data was successfully completed.
REG_WR_AKN	0	No modification of the data in the register bank by process output, i.e. REG_WR = 0. A write job would be accepted with the next telegram of process output data. (handshake for data transmission to the register.)
	1	A modification of the register contents by a process output was initiated, i.e. REG_WR = 1. A write job would not be accepted with the next telegram of process output data.
SSI_STS3	0	These four bits transfer the status bits of the SSI encoder with the status messages of the SSI module. With some SSI encoders, the status bits are transferred together with the position value.
	1	
SSI_STS2	0	
	1	
SSI_STS1	0	
	1	
SSI_STS0	0	
	1	
STS_UP (LED UP)	0	The SSI encoder values are decremented or the values are constant.
	1	The SSI encoder values are incremented.

Table 84:
Process input
data of
XN-1SSI

Designation	Value	Meaning
STS_DN (LED DN)	0	The SSI encoder values are incremented or the values are constant.
	1	The SSI encoder values are decremented.
REL_CMP2	0	A comparison of the register contents has produced the following result: $(REG_SSI_POS) < (REG_CMP2)$
	1	A comparison of the register contents has produced the following result: $(REG_SSI_POS) \geq (REG_CMP2)$
FLAG_CMP2	0	Default status, i.e. the register contents have not yet matched $(REG_SSI_POS) = (REG_CMP2)$ since the last reset.
	1	The contents of the registers match $(REG_SSI_POS) = (REG_CMP2)$. This marker must be reset with $CLR_CMP2 = 1$ in the process output data.
STS_CMP2	0	A comparison of the register contents has produced the following result: $(REG_SSI_POS) \neq (REG_CMP2)$
	1	A comparison of the register contents has produced the following result: $(REG_SSI_POS) = (REG_CMP2)$
REL_CMP1	0	A comparison of the register contents has produced the following result: $(REG_SSI_POS) < (REG_CMP1)$
	1	A comparison of the register contents has produced the following result: $(REG_SSI_POS) \geq (REG_CMP1)$
FLAG_CMP1	0	Default status, i.e. the register contents have not yet matched $(REG_SSI_POS) = (REG_CMP1)$ since the last reset.
	1	The contents of the registers match: $(REG_SSI_POS) = (REG_CMP1)$. This marker must be reset when $CLR_CMP1 = 1$ in the process output data.

9 Appendix

9.1 Data image of the technology modules

Table 84:
Process input
data of
XN-1SSI

Designation	Value	Meaning
STS_CMP1	0	A comparison of the register contents has produced the following result: $(REG_SSI_POS) \neq (REG_CMP1)$
	1	A comparison of the register contents has produced the following result: $(REG_SSI_POS) = (REG_CMP1)$
STS_STOP	0	The SSI encoder is read cyclically.
	1	Communication with the SSI encoder is stopped as $STOP = 1$ (process output) or $ERR_PARA = 1$.
ERR_PARA	0	The parameter set of the module has been accepted.
	1	Operation of the module is not possible with the present parameter set.
STS_UFLW	0	A comparison of the register contents has produced the following result: $(REG_SSI_POS) \geq (REG_LOWER_LIMIT)$
	1	A comparison of the register contents has produced the following result: $(REG_SSI_POS) < (REG_LOWER_LIMIT)$
STS_OFLW	0	A comparison of the register contents has produced the following result: $(REG_SSI_POS) \leq (REG_UPPER_LIMIT)$
	1	A comparison of the register contents has produced the following result: $(REG_SSI_POS) > (REG_UPPER_LIMIT)$
ERR_SSI	0	SSI encoder signal present.
	1	SSI encoder signal faulty. (e.g. due to a cable break).
SSI_DIAG	0	No enabled status signal is active ($SSI_STSx = 0$).
	1	At least one enabled status signal is active ($SSI_STSx = 1$).

Process output data

The field output data is transferred from the XN-1SSI module to the connected field device. The process output data is the data that is output from the PLC to the XN-1SSI module via a gateway.

This is transferred in an 8 byte format as follows:

- 1 byte contains a Stop bit for interrupting communication with the encoder.
- 1 byte is used for controlling the comparison operations.
- 1 byte contains the register address of the data to be written to bytes 0 to 3 of this telegram and a write request.
- 1 byte contains the register address for the data that is to be read with the next response telegram.
- 4 bytes are used for representing the data that is to be written to the register with the address specified at REG_WR_DATA.

Figure 85:
Process output data

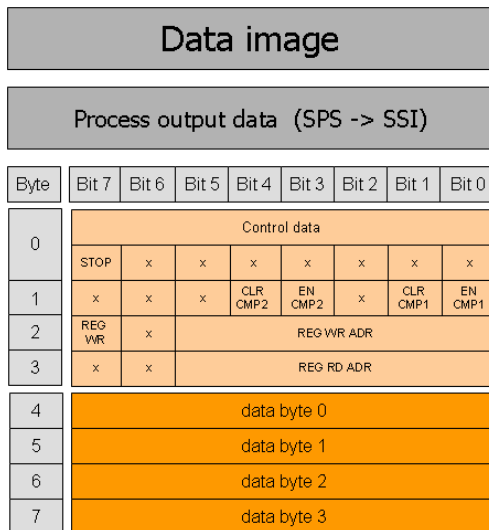

9 Appendix

9.1 Data image of the technology modules

Table 85:
Process output
data of
XN-1SSI

Designation	Value	Meaning
REG_WR_DATA	0... ($2^{32}-1$)	Value to be written to the register with the address stated at REG_WR_ADR.
REG_RD_ADR	0...63	Address of the register to be read. If the read operation is successful (REG_RD_ABORT = 0), the user data is located in REG_RD_DATA of the process input data (bytes 4 – 7).
REG_WR	0	Default status, i.e. there is no request to overwrite the content of the register with the address stated at REG_WR_ADR with REG_WR_DATA. Bit REG_WR_AKN is reset (0) if necessary.
	1	Request to overwrite the content of the register with the address stated at REG_WR_ADR with REG_WR_DATA.
REG_WR_ADR	0...63	Address of the register to be written with REG_WR_DATA.
CLR_CMP2	0	Default status, i.e. no reset of FLAG_CMP2 active.
	1	Reset of FLAG_CMP2 active
EN_CMP2	0	Default status, i.e. the data bits REL_CMP2, STS_CMP2 and FLAG_CMP2 always have the value 0, irrespective of the actual SSI encoder value.
	1	Comparison active, i.e. the data bits REL_CMP2, STS_CMP2 and FLAG_CMP2 have a value based on the result of the comparison with the SSI encoder value.
CLR_CMP1	0	Default status, i.e. reset of FLAG_CMP1 not active.
	1	Reset of FLAG_CMP1 active
EN_CMP1	0	Default status, i.e. the data bits REL_CMP1, STS_CMP1 and FLAG_CMP1 always have the value 0, irrespective of the actual SSI encoder value.
	1	Comparison active, i.e. the data bits REL_CMP1, STS_CMP1 and FLAG_CMP1 have a value based on the result of the comparison with the SSI encoder value.
STOP	0	Request to read the SSI encoder cyclically
	1	Request to interrupt communication with the encoder

9.1.5 SWIRE-module

The process data of the SWIRE-modules are mapped into the data area of the digital in- and output modules and **not** in the data area for the intelligent modules (see Chapter 5.4 Structure of the packed in-/ output process data, Page 59).

Process input data)

Byte	Bit 7	Bit 6	Bit 5	Bit 4	Bit 3	Bit 2	Bit 1	Bit 0
n -1	(Data from modules to the left)							
n	SWIRE Slave 2				SWIRE Slave 1			
	SC2		PKZST2	SI2	SC1		PKZST1	SI1
n+1	SWIRE Slave 4				SWIRE Slave 3			
	SC4		PKZST4	SI4	SC3		PKZST3	SI3
n+2	SWIRE Slave 6				SWIRE Slave 5			
	SC6		PKZST6	SI6	SC5		PKZST5	SI5
n+3	SWIRE Slave 8				SWIRE Slave 7			
	SC8		PKZST8	SI8	SC7		PKZST7	SI7
n+4	SWIRE Slave 10				SWIRE Slave 9			
	SC10		PKZST10	SI10	SC9		PKZST9	SI9
n+5	SWIRE Slave 12				SWIRE Slave 11			
	SC12		PKZST12	SI12	SC11		PKZST11	SI11
n+6	SWIRE Slave 14				SWIRE Slave 13			
	SC14		PKZST14	SI14	SC13		PKZST13	SI13
n+7	SWIRE Slave 16				SWIRE Slave 15			
	SC16		PKZST16	SI16	SC15		PKZST15	SI15
n+8 ff.	(Data from modules to the right)							

9 Appendix

9.1 Data image of the technology modules

Table 86:
Process input
data of
XNE-1SWIRE

Designation	Value	Meaning
Slx	Switch status, relay x	
	Slx supplies the switch status of the contactor coil of the SWIRE slave as a feedback signal. Slx makes it possible to check whether the set switch status was executed by a mechanical connection. This must take into account the time delay between the setting of an output, a mechanical execution and the subsequent feedback signal.	
	0	Off Contactor coil is switched off
	1	On Contactor coil is switched on
PKZSTx	Switch status, PKZ x	
	0	Off The motor-protective circuit-breaker is off or has tripped
	1	On The motor-protective circuit-breaker is switched on
SCx	Communication error, slave x	
	Setting the SC _{DIAG} Sx parameter sets the SCx bit in the process input data. The information is provided as status information in the PLC for the user.	
	0	ON LINE Status of slave x: Everything o.k.
	1	OFF LINE Status of slave x: Slave diagnostics message present

Process output data

Byte	Bit 7	Bit 6	Bit 5	Bit 4	Bit 3	Bit 2	Bit 1	Bit 0
n -1	(Data from modules to the left)							
n	SWIRE Slave 2				SWIRE Slave 1			
				SO2				SO1
n+1	SWIRE Slave 4				SWIRE Slave 3			
				SO4				SO3
n+2	SWIRE Slave 6				SWIRE Slave 5			
				SO6				SO5
n+3	SWIRE Slave 8				SWIRE Slave 7			
				SO8				SO7
n+4	SWIRE Slave 10				SWIRE Slave 9			
				SO10				SO9
n+5	SWIRE Slave 12				SWIRE Slave 11			
				SO12				SO11
n+6	SWIRE Slave 14				SWIRE Slave 13			
				SO14				SO13
n+7	SWIRE Slave 16				SWIRE Slave 15			
				SO16				SO15
n+8 ff.	(Data from modules to the right)							

Table 87:
Process output
data of
XNE-1SWIRE

Designation	Value	Meaning
SOx		relay x
		SOx is transferred as the switch status of the contactor coil from the SWIRE bus master to the appropriate SWIRE slave.
	0	Off Contactor not switched on
	1	On Contactor is switched on

9 Appendix

9.2 Ident codes of the XI/ON modules

9.2 Ident codes of the XI/ON modules

Each module modul is identified by the gateway with the help of a module-specific ident code.

Table 88:
Module ident
codes

Module	Ident code
<i>Digital input modules</i>	
XN-2DI-24VDC-P	0x210020xx
XN-2DI-24VDC-N	0x220020xx
XN-2DI-120/230VAC	0x230020xx
XN-4DI-24VDC-P	0x410030xx
XN-4DI-24VDC-N	0x420030xx
XN-16DI-24VDC-P	0x810050xx
XN-32DI-24VDC-P	0xA10070xx
XNE-8DI-24VDC-P	0x610040xx
XNE-16DI-24VDC-P	0x820050xx
<i>Analog input modules</i>	
XN-1AI-I(0/4...20MA)	0x012350xx
XN-2AI-I(0/4...20MA)	0x225570xx
XN-1AI-U(-10/0...+10VDC)	0x011350xx
XN-2AI-U(-10/0...+10VDC)	0x235570xx
XN-2AI-PT/NI-2/3	0x215770xx
XN-2AI-THERMO-PI	0x215570xx
XN-4AI-U/I	0x417790xx
XNE-8AI-U/I-4PT/NI	0x6199B0xx
<i>Digital output modules</i>	
XN-2DO-24VDC-0.5A-P	0x212002xx
XN-2DO-24VDC-0.5A-N	0x222002xx
XN-2DO-24VDC-2A-P	0x232002xx
XN-2DO-120/230VAC-0.5A	0x250002xx
XN-4DO-24VDC-0.5A-P	0x013003xx
XN-16DO-24VDC-0.5A-P	0x413005xx
XN-32DO-24VDC-0.5A-P	0x614007xx
XNE-8DO-24VDC-0.5A-P	0x610004xx

Table 88:
Module ident
codes

Module	Ident code
XNE-16DO-24VDC-0.5A-P	0x820005xx
<i>Analog output modules</i>	
XN-1AO-I(0/4...20MA)	0x010605xx
XN-2AO-I(0/4...20MA)	0x220807xx
XN-2AO-U(-10/0...+10VDC)	0x210807xx
XNE-4AO-U/I	0x417A09xx
<i>Relay modules</i>	
XN-2DO-R-NC	0x230002xx
XN-2DO-R-NO	0x220002xx
XN-2DO-R-CO	0x210002xx
<i>Technology modules</i>	
XN-1CNT-24VDC	0x014B99xx
XNE-2CNT-2PWM	0x017BCCxx
XN-1RS232	0x014799xx
XN-1RS485/422	0x024799xx
XN-1SSI	0x044799xx
XNE-1SWIRE	0x169C99xx
<i>Power supply modules</i>	
XN-BR-24VDC-D	0x013000xx
XN-PF-24VDC-D	0x023000xx
XN-PF-120/230VAC-D	0x053000xx

9.3 Glossary

Acknowledge

Acknowledgment of a signal received.

Active metal component

Conductor or conducting component that is electrically live during operation.

Address

Identification number of, e.g. a memory position, a system or a module within a network.

Addressing

Allocation or setting of an address, e. g. for a module in a network.

ARP

Used to definitely allocate the hardware addresses (MAC-IDs) assigned worldwide to the IP addresses of the network clients via internal tables.

Analog

Infinitely variable value, e. g. voltage. The value of an analog signal can take on any value, within certain limits.

Automation device

A device connected to a technical process with inputs and outputs for control. Programmable logic controllers (PLC) are a special group of automation devices.

Baud

Baud is a measuring unit for the transmission speed of data. 1 Baud corresponds to the transmission of one step per second. If one bit is transmitted per step, the baud rate is identical to the transmission rate in bit per second (bit/s).

Baud rate

See „Baud“.

Bidirectional

Working in both directions.

Bonding strap

Flexible conductor, normally braided, that joins inactive components, e. g. the door of a switchgear cabinet to the cabinet main body.

Bus

Bus system for data exchange, e. g. between CPU, memory and I/O levels. A bus can consist of several parallel cables for data transmission, addressing, control and power supply.

Bus cycle time

Time required for a master to serve all slaves or stations in a bus system, i. e. reading inputs and writing outputs.

Bus line

Smallest unit connected to a bus, consisting of a PLC, a coupling element for modules on the bus and a module.

Bus system

All units which communicate with one another via a bus.

Capacitive coupling

Electrical capacitive couplings occur between cables with different potentials. Typical sources of interference are, for example, parallel-routed signal cables, contactors and electrostatic discharges.

Check-back interface

The check-back interface is the interface from the counter module to the internal module bus. The bits and bytes are converted by the gateway from the respective type of communication applicable to the field bus in to the module-specific bits and bytes.

Coding elements

Two-piece element for the unambiguous assignment of electronic and base modules.

Configuration

Systematic arrangement of the I/O-modules of a station.

Control interface

The control interface is the interface from the internal module bus to the counter module. The commands and signals directed to the counter module are converted by the gateway from the respective type of communication applicable to the field bus in to the module-specific bits and bytes.

CPU

Central Processing Unit. Central unit for electronic data processing, the processing core of the PC.

DHCP

Client-Server-protocol which reduces the effort of assigning IP addresses or other parameters. Serves for dynamic and automatic configuration of devices.

Digital

A value (e. g. a voltage) which can adopt only certain statuses within a finite set, mostly defined as 0 and 1.

DIN

German acronym for German Industrial Standard.

EIA

Electronic Industries Association – association of electrical companies in the United States.

Electrical components

All objects that produce, convert, transmit, distribute or utilize electrical power (e. g. conductors, cable, machines, control devices).

EMC

Electromagnetic compatibility – the ability of an electrical part to operate in a specific environment without fault and without exerting a negative influence on its environment.

EN

German acronym for European Standard.

ESD

Electrostatic Discharge.

Field power supply

Voltage supply for devices in the field as well as the signal voltage.

Field bus

Data network on sensor/actuator level. A field bus connects the equipment on the field level. Characteristics of a field bus are a high transmission security and real-time behavior.

9 Appendix

9.3 Glossary

Force Mode

Software mode which enables the user to set his plant to a required state by forcing certain variables on the input and output modules.

GND

Abbreviation of ground (potential "0").

Ground

Expression used in electrical engineering to describe an area whose electrical potential is equal to zero at any given point. In neutral grounding devices, the potential is not necessarily zero, and one speaks of the ground reference.

Ground connection

One or more components that have a good and direct contact to earth.

Ground reference

Potential of ground in a neutral grounding device. Unlike earth whose potential is always zero, it may have a potential other than zero.

Hexadecimal

System of representing numbers in base 16 with the digits 0... 9, and further with the letters A, B, C, D, E and F.

Hysteresis

A sensor can get caught up at a certain point, and then "waver" at this position. This condition results in the counter content fluctuating around a given value. Should a reference value be within this fluctuating range, then the relevant output would be turned on and off in rhythm with the fluctuating signal.

I/O

Input/output.

Impedance

Total effective resistance that a component or circuit has for an alternating current at a specific frequency.

Inactive metal components

Conductive components that cannot be touched and are electrically isolated from active metal components by insulation, but can adopt voltage in the event of a fault.

Inductive coupling

Magnetic inductive couplings occur between two cables through which an electrical current is flowing. The magnetic effect caused by the electrical currents induces an interference voltage. Typical sources of interference are for example, transformers, motors, parallel-routed network and HF signal cables.

Intelligent modules

Intelligent modules are modules with an internal memory, able to transmit certain commands (e. g. substitute values and others).

IP

Abbreviation for Internet-Protocol, protocol for the packet-oriented and connectionless transport of data packets from a transmitter to a receiver crossing different networks.

Lightning protection

All measures taken to protect a system from damage due to overvoltages caused by lightning strike.

Low impedance connection

Connection with a low AC impedance.

LSB

Least Significant bit

Mass

All interconnected inactive components that do not take on a dangerous touch potential in the case of a fault.

Master

Station in a bus system that controls the communication between the other stations.

Modbus TCP

The Modbus protocol is part of the TCP/IP protocol.

The communication is realized via function codes, which are implemented into the data telegram.

Modbus TCP uses the Transmission Control Protocol (TCP) for the transmission of the Modbus user protocol in Ethernet-TCP-IP networks.

Module bus

The module bus is the internal bus in a XI/ON station. The XI/ON modules communicate with the gateway via the module bus which is independent of the field bus.

MSB

Most Significant bit

Ping

Implementation of an echo-protocol, used for testing whether a particular host is operating properly and is reachable on the network from the testing host.

PLC

Programmable Logic Controller.

Potential compensation

The alignment of electrical levels of electrical components and external conductive components by means of an electrical connection.

Potential free

Galvanic isolation of the reference potentials in I/O-modules of the control and load circuits.

Potential linked

Electrical connection of the reference potentials in I/O-modules of the control and load circuits.

Protective earth

Electrical conductor for protection against dangerous shock currents. Generally represented by PE (protective earth).

Radiation coupling

A radiation coupling appears when an electromagnetic wave hits a conductive structure. Voltages and currents are induced by the collision. Typical sources of interference are for example, sparking gaps (spark plugs, commutators from electric motors) and transmitters (e. g. radio), that are operated near to conducting structures.

Reaction time

The time required in a bus system between a reading operation being sent and the receipt of an answer. It is the time required by an input module to change a signal at its input until the signal is sent to the bus system.

Reference potential

Potential from which all voltages of connected circuits are viewed and/or measured.

Repeater

Amplifier for signals transmitted via a bus.

Root-connecting

Creating a new potential group using a power supply module. This allows sensors and loads to be supplied individually.

RS 485

Serial interface in accordance with EIA standards, for fast data transmission via multiple transmitters.

Serial

Type of information transmission, by which data is transmitted bit by bit via a cable.

Setting parameters

Setting parameters of individual stations on the bus and their modules in the configuration software of the master.

Shield

Conductive screen of cables, enclosures and cabinets.

Shielding

Description of all measures and devices used to join installation components to the shield.

Short-circuit proof

Characteristic of electrical components. A short-circuit proof part withstands thermal and dynamic loads which can occur at its place of installation due to a short circuit.

Station

A functional unit or I/O components consisting of a number of elements.

TCP

Abbreviation for Transmission Control Protocol, connection-oriented transport protocol within the Internet protocol suite. Certain error detection mechanisms (i.e. acknowledgements, time-out monitoring) can guarantee a safe and error free data transport.

Terminating resistance

Resistor on both ends of a bus cable used to prevent interfering signal reflections and which provides bus cable matching. Terminating resistors must always be the last component at the end of a bus segment.

To ground

Connection of a conductive component with the grounding connection via a grounding installation.

Topology

Geometrical structure of a network or the circuitry arrangement.

UDP

Abbreviation for User Datagram Protocol. UDP is a transport protocol for the connectionless data between Ethernet hosts.

Unidirectional

Working in one direction.

10 Index

A

addressing 35
 APR (Address Resolution Protocol) 26

B

base modules 19

C

communication bytes 139
 C-rail (cross connection) 143

E

earth-free operation 152
 electromagnetic compatibility 152
 electronics modules 17
 electrostatic discharge 155
 EMC 152
 end bracket 20
 end plate 20
 ESD, electrostatic discharge 155
 Ethernet 23
 – data transfer 24
 – IP address 23
 – MAC-ID 23
 – manufacturer identifier 23
 – netmask 23
 – network classes 24
 – subnet ID 23
 – system description 23

F

firmware download 147

G

gateway 15
 – addressing 35
 – BOOTP-mode 40
 – DHCP-mode 39
 – DIP-switches 37
 – mode function 36
 – PGM-mode 41
 – structure 29
 – technical data 28
 gateway-status 118
 group diagnosis 133

I

ident-number 120
 inductive loads, protective circuit 155

IP (Internet Protocol) 24
 IP address 23
 – PC 110

J

jumper 21

L

labels 21

M

markers 21
 maximum system extension 139
 Modbus TCP 25
 – communication examples 116
 – registers 49
 module arrangement 137
 module diagnosis 134
 module diagnostics
 – evaluation 133
 module list 121
 mounting rail 153

N

network configuration 109

O

Output behavior 68

P

parameterization 129
 PE connection 152
 potential relationships 151
 potential-compensation cable 155
 power supply 17, 33, 142
 process image length 122
 Process input
 – XN-1CNT-24VDC, counter mode 157
 – XN-1CNT-24VDC, measurement mode 160
 – XN-1RS232 179
 – XN-1RS485/422 179
 – XN-1SSI 183
 – XNE-1SWIRE 189
 – XNE-2CNT-2PWM 170
 Process output
 – XN-1CNT-24VDC, counter mode 162
 – XN-1CNT-24VDC, measurement mode 167
 – XN-1RS232 181
 – XN-1RS485/422 181

10 Index

– XN-1SSI	187
– XNE-1SWIRE	191
– XNE-2CNT-2PWM	175
product overview	13

R

reference module list	119
-----------------------------	-----

S

service interface	34
shield connection	
– analog modules	22
– gateway	22
shielding	154

station planning	137
------------------------	-----

T

TCP (Transmission Control Protocol)	24
TCP/IP host	23

W

WIN 2000	110
WIN NT	111
WIN XP	110

X

XI/ON components	15
------------------------	----