



# DBS36E-BBCK00360

DBS36/50

INCREMENTAL ENCODERS

**SICK**  
Sensor Intelligence.



Illustration may differ



### Ordering information

| Type             | Part no. |
|------------------|----------|
| DBS36E-BBCK00360 | 1077949  |

Other models and accessories → [www.sick.com/DBS36\\_50](http://www.sick.com/DBS36_50)

### Detailed technical data

#### Performance

|                                 |                                     |
|---------------------------------|-------------------------------------|
| <b>Pulses per revolution</b>    | 360                                 |
| <b>Measuring step</b>           | 90°, electric/pulses per revolution |
| <b>Measuring step deviation</b> | ± 18° / pulses per revolution       |
| <b>Error limits</b>             | ± 54° / pulses per revolution       |
| <b>Duty cycle</b>               | ≤ 0.5 ± 5 %                         |

#### Interfaces

|                                       |                        |
|---------------------------------------|------------------------|
| <b>Communication interface</b>        | Incremental            |
| <b>Communication Interface detail</b> | TTL / RS-422           |
| <b>Number of signal channels</b>      | 6-channel              |
| <b>Initialization time</b>            | < 3 ms                 |
| <b>Output frequency</b>               | ≤ 300 kHz              |
| <b>Load current</b>                   | ≤ 30 mA                |
| <b>Power consumption</b>              | ≤ 0.5 W (without load) |

#### Electrical data

|  |   |
|--|---|
| <b>Connection type</b>                         | Cable, 8-wire, universal, 1.5 m             |
| <b>Supply voltage</b>                          | 7 ... 30 V                                  |
| <b>Reference signal, number</b>                | 1   |
| <b>Reference signal, position</b>              | 90°, electric, logically gated with A and B |
| <b>Reverse polarity protection</b>             | ✓   |
| <b>Short-circuit protection of the outputs</b> | ✓ <sup>1)</sup>                             |
| <b>MTTFd: mean time to dangerous failure</b>   | 600 years (EN ISO 13849-1) <sup>2)</sup>    |

<sup>1)</sup> The short-circuit rating is only given if Us and GND are connected correctly.

<sup>2)</sup> This product is a standard product and does not constitute a safety component as defined in the Machinery Directive. Calculation based on nominal load of components, average ambient temperature 40 °C, frequency of use 8760 h/a. All electronic failures are considered hazardous. For more information, see document no. 8015532.

#### Mechanical data

|                          |                    |
|--------------------------|--------------------|
| <b>Mechanical design</b> | Blind hollow shaft |
|--------------------------|--------------------|

<sup>1)</sup> Order collets for 5 mm, 6 mm and 1/4" mm separately as accessories.

<sup>2)</sup> Higher values are possible using limited bearing life.

<sup>3)</sup> Allow for self-heating of 4.7 K per 1,000 rpm when designing the operating temperature range.

<sup>4)</sup> No permanent operation. Decreasing signal quality.

|                                       |   |
|---------------------------------------|---|
| <b>Shaft diameter</b>                 | 8 mm <sup>1)</sup>                                  |
| <b>Weight</b>                         | + 150 g (with connecting cable)                     |
| <b>Shaft material</b>                 | Stainless steel                                     |
| <b>Flange material</b>                | Aluminum  |
| <b>Housing material</b>               | Aluminum  |
| <b>Material, cable</b>                | PVC   |
| <b>Start up torque</b>                | + 0.5 Ncm (+20 °C)                                  |
| <b>Operating torque</b>               | 0.4 Ncm (+20 °C)                                    |
| <b>Permissible movement static</b>    | ± 0.3 mm (radial)<br>± 0.5 mm (axial) <sup>2)</sup> |
| <b>Permissible movement dynamic</b>   | ± 0.1 mm (radial)<br>± 0.2 mm (axial) <sup>2)</sup> |
| <b>Operating speed</b>                | 6,000 min <sup>-1</sup> <sup>3)</sup>               |
| <b>Maximum operating speed</b>        | ≤ 8,000 min <sup>-1</sup> <sup>4)</sup>             |
| <b>Moment of inertia of the rotor</b> | 0.8 gcm <sup>2</sup>                                |
| <b>Bearing lifetime</b>               | 2 x 10 <sup>9</sup> revolutions                     |
| <b>Angular acceleration</b>           | ≤ 500,000 rad/s <sup>2</sup>                        |

<sup>1)</sup> Order collets for 5 mm, 6 mm and 1/4" mm separately as accessories.

<sup>2)</sup> Higher values are possible using limited bearing life.

<sup>3)</sup> Allow for self-heating of 4.7 K per 1,000 rpm when designing the operating temperature range.

<sup>4)</sup> No permanent operation. Decreasing signal quality.

## Ambient data

|                                      |  |
|--------------------------------------|--|
| <b>EMC</b>                           | According to EN 61000-6-2 and EN 61000-6-3 (class A) |
| <b>Enclosure rating</b>              | IP65   |
| <b>Permissible relative humidity</b> | 90 % (Condensation not permitted)                    |
| <b>Operating temperature range</b>   | -20 °C ... +85 °C, -35 °C ... +95 °C on request      |
| <b>Storage temperature range</b>     | -40 °C ... +100 °C, without package                  |
| <b>Resistance to shocks</b>          | 100 g, 6 ms (EN 60068-2-27)                          |
| <b>Resistance to vibration</b>       | 20 g, 10 Hz ... 2,000 Hz (EN 60068-2-6)              |

## Classifications

|                     |          |
|---------------------|----------|
| <b>eCl@ss 5.0</b>   | 27270501 |
| <b>eCl@ss 5.1.4</b> | 27270501 |
| <b>eCl@ss 6.0</b>   | 27270590 |
| <b>eCl@ss 6.2</b>   | 27270590 |
| <b>eCl@ss 7.0</b>   | 27270501 |
| <b>eCl@ss 8.0</b>   | 27270501 |
| <b>eCl@ss 8.1</b>   | 27270501 |
| <b>eCl@ss 9.0</b>   | 27270501 |
| <b>eCl@ss 10.0</b>  | 27270501 |
| <b>eCl@ss 11.0</b>  | 27270501 |
| <b>eCl@ss 12.0</b>  | 27270501 |
| <b>ETIM 5.0</b>     | EC001486 |

|                       |          |
|-----------------------|----------|
| <b>ETIM 6.0</b>       | EC001486 |
| <b>ETIM 7.0</b>       | EC001486 |
| <b>ETIM 8.0</b>       | EC001486 |
| <b>UNSPSC 16.0901</b> | 41112113 |

### Dimensional drawing (Dimensions in mm (inch))

Blind hollow shaft, cable

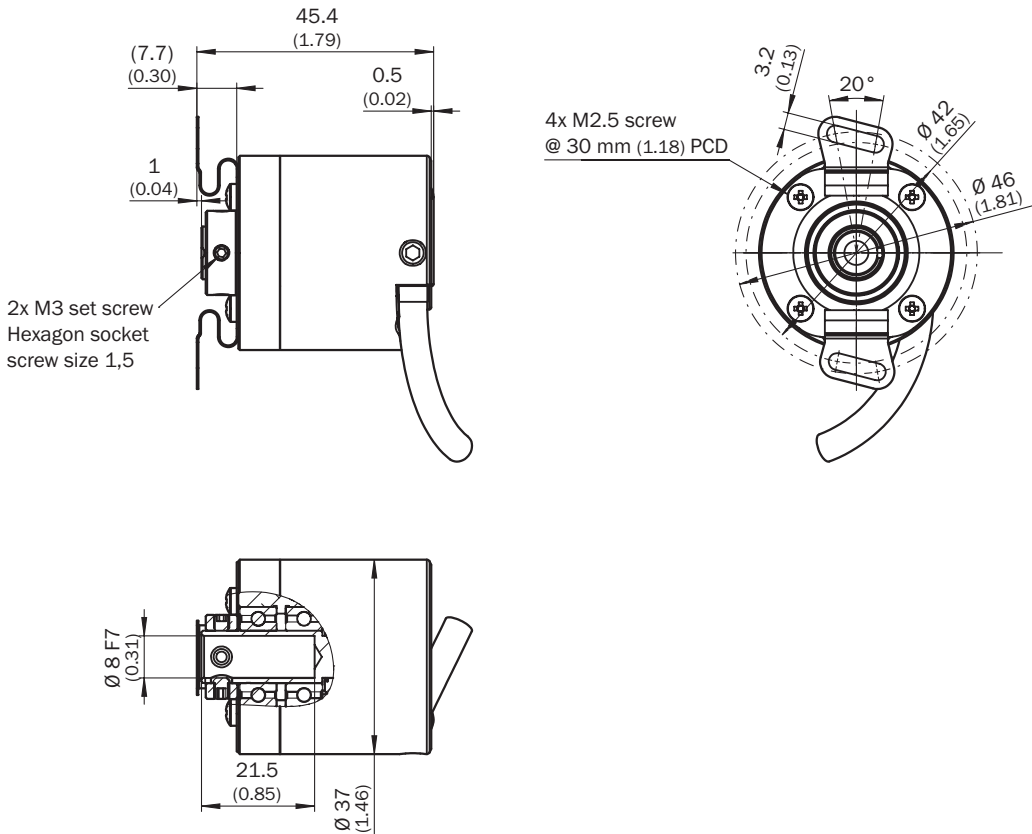

### Attachment specifications

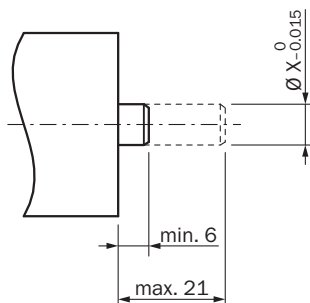

|      |           | Encoder |         |
|------|-----------|---------|---------|
| 6 mm | DBS36E-BA |         | 2056390 |

|      | Encoder   |              |
|------|-----------|--------------|
| 5 mm | DBS36E-BB | Premounted   |
| 6 mm |           | 2066991      |
| 1/4" |           | 2056390      |
| 8 mm |           | On request   |
|      |           | Not required |

PIN assignment

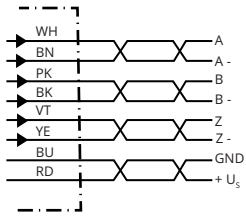

| Wire colors (cable connection) | Male connector M12, 8-pin | Male connector M23, 12-pin | TTL/HTL 6-channel signal | Explanation                         |
|--------------------------------|---------------------------|----------------------------|--------------------------|-------------------------------------|
| Brown                          | 1                         | 6                          | A-                       | Signal wire                         |
| White                          | 2                         | 5                          | A                        | Signal wire                         |
| Black                          | 3                         | 1                          | B-                       | Signal wire                         |
| Pink                           | 4                         | 8                          | B                        | Signal wire                         |
| Yellow                         | 5                         | 4                          | Z-                       | Signal wire                         |
| Purple                         | 6                         | 3                          | Z                        | Signal wire                         |
| Blue                           | 7                         | 10                         | GND                      | Ground connection                   |
| Red                            | 8                         | 12                         | +U <sub>s</sub>          | Supply voltage                      |
| -                              | -                         | 9                          | Not assigned             | Not assigned                        |
| -                              | -                         | 2                          | Not assigned             | Not assigned                        |
| -                              | -                         | 11                         | Not assigned             | Not assigned                        |
| -                              | -                         | 7                          | Not assigned             | Not assigned                        |
| Screen                         | Screen                    | Screen                     | Screen                   | Screen connected to encoder housing |

### Diagrams

Signal outputs for electrical interfaces TTL and HTL



Cw with view on the encoder shaft in direction "A", compare dimensional drawing.





① Interfaces G, P, R only for channels A, B, Z.

| Supply voltage | Output                        |
|----------------|-------------------------------|
| 4.5 V...5.5 V  | TTL/RS422                     |
| 7 V...30 V     | TTL/RS422                     |
| 7 V...30 V     | HTL/Push Pull                 |
| 7 V...27 V     | HTL/push pull, 3 channel      |
| 4.5 V...5.5 V  | Open Collector NPN, 3 channel |
| 4.5 V...30 V   | Open Collector NPN, 3 channel |

### Recommended accessories

Other models and accessories → [www.sick.com/DBS36\\_50](http://www.sick.com/DBS36_50)

|   | Brief description   | Type           | Part no. |
|---|---|----------------|----------|
| <b>Other mounting accessories</b>   |   |                |          |
|  | Two-sided stator coupling, screw hole diameter 42 to 46 mm, slot width 3.2 mm                             | BEF-DS-DBS36   | 2066301  |
| <b>Plug connectors and cables</b>   |   |                |          |
|  | Head A: cable<br>Head B: Flying leads<br>Cable: SSI, Incremental, HIPERFACE®, PUR, halogen-free, shielded | LTG-2308-MWENC | 6027529  |
|  | Head A: cable<br>Head B: Flying leads<br>Cable: SSI, Incremental, PUR, shielded                           | LTG-2411-MW    | 6027530  |
|  | Head A: cable<br>Head B: Flying leads<br>Cable: SSI, Incremental, PUR, halogen-free, shielded             | LTG-2512-MW    | 6027531  |

|   | Brief description   | Type          | Part no. |
|---|---|---------------|----------|
|  | Head A: cable<br>Head B: Flying leads<br>Cable: SSI, TTL, HTL, Incremental, PUR, halogen-free, shielded     | LTG-2612-MW   | 6028516  |
|  | Head A: male connector, M12, 8-pin, straight, A-coded<br>Cable: Incremental, shielded                       | STE-1208-GA01 | 6044892  |
|  | Head A: male connector, M23, 12-pin, straight<br>Cable: HIPERFACE <sup>®</sup> , SSI, Incremental, shielded | STE-2312-G01  | 2077273  |
|  |   | STE-2312-GX   | 6028548  |

## SICK AT A GLANCE

SICK is one of the leading manufacturers of intelligent sensors and sensor solutions for industrial applications. A unique range of products and services creates the perfect basis for controlling processes securely and efficiently, protecting individuals from accidents and preventing damage to the environment.

We have extensive experience in a wide range of industries and understand their processes and requirements. With intelligent sensors, we can deliver exactly what our customers need. In application centers in Europe, Asia and North America, system solutions are tested and optimized in accordance with customer specifications. All this makes us a reliable supplier and development partner.

Comprehensive services complete our offering: SICK LifeTime Services provide support throughout the machine life cycle and ensure safety and productivity.

For us, that is “Sensor Intelligence.”

## WORLDWIDE PRESENCE:

Contacts and other locations –[www.sick.com](http://www.sick.com)