



SKS36-HVA0-K02

SKS/SKM36

MOTOR FEEDBACK SYSTEMS ROTARY HIPERFACE®

SICK
Sensor Intelligence.

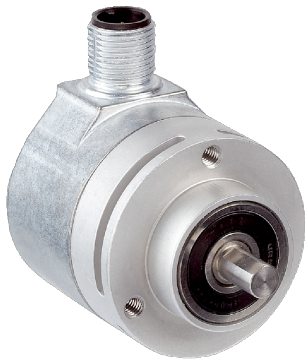

Illustration may differ



Ordering information

Type	Part no.
SKS36-HVA0-K02	1035603

Other models and accessories → www.sick.com/SKS_SKM36

Detailed technical data

Performance

Sine/cosine periods per revolution	128
Number of the absolute ascertainable revolutions	1
Total number of steps	4,096
Measuring step	2.5 " For interpolation of the sine/cosine signals with, e. g., 12 bits
Integral non-linearity	± 120 ", Error limits for evaluating sine/cosine period
Differential non-linearity	Non-linearity within a sine/cosine period
Operating speed	≤ 6,000 min ⁻¹ , up to which the absolute position can be reliably produced
Available memory area	1,792 Byte
System accuracy	± 120 "

Interfaces

Type of code for the absolute value	Binary
Code sequence	Increasing, when turning the shaft For clockwise rotation, looking in direction "A" (see dimensional drawing), For clockwise shaft rotation, looking in direction "A" (see dimensional drawing)
Communication interface	HIPERFACE®

Electrical data

Connection type	Male connector, M12, 8-pin, radial
Supply voltage	7 V DC ... 12 V DC
Recommended supply voltage	8 V DC
Current consumption	60 mA ¹⁾
Output frequency for sine/cosine signals	≤ 65 kHz
MTTF: mean time to dangerous failure	205 years (EN ISO 13849) ²⁾

¹⁾ Without load.

²⁾ This product is a standard product and does not constitute a safety component as defined in the Machinery Directive. Calculation based on nominal load of components, average ambient temperature 60°C, frequency of use 8760 h/a. All electronic failures are considered hazardous. For more information, see document no. 8015532.

Mechanical data

Shaft version	Solid shaft
Flange type / stator coupling	Servo-/face mount flange, stator coupling
Dimensions	See dimensional drawing
Weight	≤ 0.07 kg
Moment of inertia of the rotor	6 gcm ²
Operating speed	12,000 min ⁻¹ , 12,000 U/min
Angular acceleration	≤ 500,000 rad/s ²
Operating torque	0.6 Ncm
Start up torque	+ 0.9 Ncm
Permissible shaft loading	10 N (radial) 5 N (axial)
Life of ball bearings	2.0 x 10 ⁹ revolutions

Ambient data

Operating temperature range	-20 °C ... +100 °C
Storage temperature range	-40 °C ... +125 °C, without package
Relative humidity/condensation	90 %, Condensation not permitted
Resistance to shocks	100 g, 6 ms, 6 ms (according to EN 60068-2-27)
Frequency range of resistance to vibrations	50 g, 10 Hz ... 2,000 Hz (EN 60068-2-6)
EMC	According to EN 61000-6-2 and EN 61000-6-3
Enclosure rating	IP50, with mating connector inserted (IEC 60529)

Classifications

eCl@ss 5.0	27270590
eCl@ss 5.1.4	27270590
eCl@ss 6.0	27270590
eCl@ss 6.2	27270590
eCl@ss 7.0	27270590
eCl@ss 8.0	27270590
eCl@ss 8.1	27270590
eCl@ss 9.0	27270590
eCl@ss 10.0	27273805
eCl@ss 11.0	27273901
eCl@ss 12.0	27273901
ETIM 5.0	EC001486
ETIM 6.0	EC001486
ETIM 7.0	EC001486
ETIM 8.0	EC001486
UNSPSC 16.0901	41112113

Dimensional drawing (Dimensions in mm (inch))

General tolerances according to DIN ISO 2768-mk

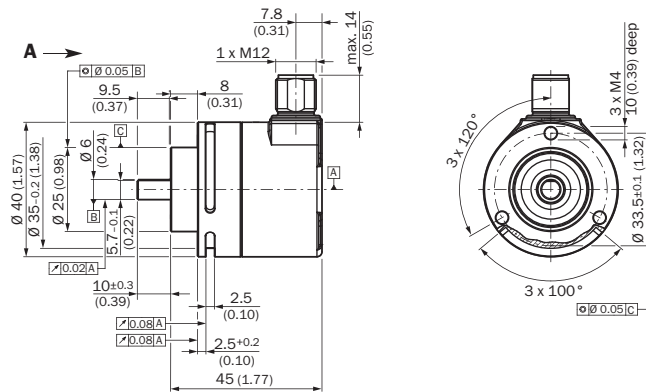

PIN assignment

View of the plug-in face

Connector 8-pin

8-pin A-coded

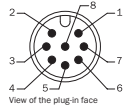

PIN	Color of wires	Signal	Explanation
1	Brown	REFSIN	Process data channel
2	White	+ SIN	Process data channel
3	Black	REFCOS	Process data channel
4	Pink	+ COS	Process data channel
5	Gray or yellow	Data +	RS-485 parameter channel
6	Green or purple	Data -	RS-485 parameter channel
7	Blue	GND	Ground connection
8	Red	+U _s	Encoder supply voltage
-	-	Screen	Housing potential. Screening via plug housing.

Electrically adjustable via programming tool

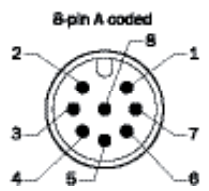

View of the plug-in face

PIN	Colour of wires	Signal	Explanation
1	brown	REFSIN	Process data channel
2	white	+ SIN	Process data channel
3	black	REFCOS	Process data channel
4	pink	+ COS	Process data channel
5	grey or yellow	Daten +	RS-485 Parameter channel
6	green or purple	Daten -	RS-485 Parameter channel
7	blue	GND	Ground connection
8	red	+ U _s	Encoder Supply voltage
	Screen		Housing potential



Diagrams

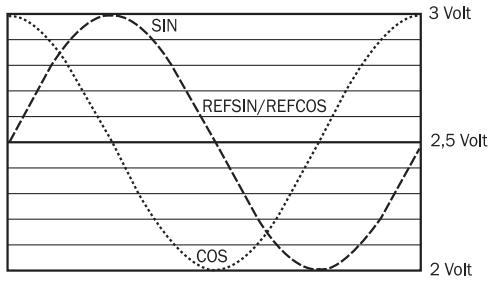





Signal diagram for clockwise shaft rotation, looking in direction “A” (see dimensional drawing) 1 period = 360° : 128



Recommended accessories

Other models and accessories → www.sick.com/SKS_SKM36

	Brief description	Type	Part no.
Programming and configuration tools			
	SVip® LAN programming tool for all motor feedback systems	PGT-11-S LAN	1057324
Flanges			
	Flange adapter, adapts face mount flange with 20 mm centering collar to 33 mm servo flange, Aluminum	BEF-FA-020-033	2066312
	Flange adapter, adaption of 25 mm spigot face mount flange to 60s face mount flange with 36 mm centering collar, Aluminum	BEF-FA-025-036	2034226
	Flange adapter, adapts SKS/SKM36 servo/face mount flange encoder with 25 mm centering collar to size 60 mm face mount flange with 36 mm centering collar, Aluminum	BEF-FA-025-036-SK	2083558
	Flange adapter, adaption of 25 mm spigot face mount flange to 50 mm servo flange, Aluminum	BEF-FA-025-050	2032622
	Flange adapter, adapts SKS/SKM36 face mount flange encoder with 25 mm centering collar to 50 mm servo flange, Aluminum	BEF-FA-025-050-SK	2083559
	Flange adapter, adaption of 25 mm spigot face mount flange to 60 mm square installation plate, Aluminum	BEF-FA-025-060RCA	2032623
	Flange adapter, adaption of 25 mm spigot face mount flange to 60 mm square installation plate with shock-absorber, Aluminum	BEF-FA-025-060RSA	2032624
	Flange adapter, adapts face mount flange with 25 mm centering collar to 63 mm square mounting plate, Aluminum	BEF-FA-025-063-REC	2033631
	Flange adapter, adapts SKS/SKM36 servo/face mount flange encoder with 25 mm centering collar to 60 mm square mounting plate, Aluminum	BEF-FA025060R-CASK	2083560
	Flange adapter, adapts SKS/SKM36 face mount flange encoder with 25 mm centering collar to 60 mm square mounting plate with shock absorbers, Aluminum	BEF-FA025060RSASK	2083561

	Brief description	Type	Part no.
	Flange adapter, adapts SKS/SKM36 servo/face mount flange encoder with 25 mm centering collar to 63 mm square mounting plate, Aluminum	BEF-FA025063RECSK	2083562
Mounting brackets and plates			
	Mounting brackets for encoders with a centering spigot 25 mm, mounting kit for face mount flange included	BEF-WF-25	2032621
	Mounting bracket for SKS/SKM36 servo/face mount flange encoder with 25 mm centering collar, mounting kit for face mount flange included	BEF-WF-25-SK	2083557
Other mounting accessories			
	Servo clamps, small, for servo flange (clamps, eccentric fastener), 3 pcs, without mounting material, without mounting hardware	BEF-WK-RESOL	2039082
Plug connectors and cables			
	LTG-2708-MW	LTG-2708-MW	6028361
	Head A: female connector, M12, 8-pin, straight Head B: Flying leads Cable: Incremental, SSI, PUR, halogen-free, shielded, 2 m	DOL-1208-G02MAC1	6032866
	Head A: female connector, M12, 8-pin, straight Head B: Flying leads Cable: Incremental, SSI, PUR, halogen-free, shielded, 5 m	DOL-1208-G05MAC1	6032867
	Head A: female connector, M12, 8-pin, straight Head B: Flying leads Cable: Incremental, SSI, PUR, halogen-free, shielded, 10 m	DOL-1208-G10MAC1	6032868
	Head A: female connector, M12, 8-pin, straight Head B: Flying leads Cable: Incremental, SSI, PUR, halogen-free, shielded, 20 m	DOL-1208-G20MAC1	6032869
	Head A: female connector, M12, 8-pin, straight Cable: shielded	DOS-1208-GA	6028369
	Head A: male connector, M12, 8-pin, straight Cable: shielded	STE-1208-GA	6028370
Shaft adaptation			
	Bellows coupling, shaft diameter 6 mm / 6 mm, maximum shaft offset: radial ± 0.25 mm, axial ± 0.4 mm, angular $\pm 4^\circ$; max. speed 10,000 rpm, -30°C to $+120^\circ\text{C}$, max. torque 120 Ncm; material: stainless steel bellows, aluminum hub	KUP-0606-B	5312981
	Bellows coupling, shaft diameter 6 mm / 10 mm, maximum shaft offset: radial ± 0.25 mm, axial ± 0.4 mm, angular $\pm 4^\circ$; max. speed 10,000 rpm, -30°C to $+120^\circ\text{C}$, max. torque 120 Ncm; material: stainless steel bellows, aluminum hub	KUP-0610-B	5312982

SICK AT A GLANCE

SICK is one of the leading manufacturers of intelligent sensors and sensor solutions for industrial applications. A unique range of products and services creates the perfect basis for controlling processes securely and efficiently, protecting individuals from accidents and preventing damage to the environment.

We have extensive experience in a wide range of industries and understand their processes and requirements. With intelligent sensors, we can deliver exactly what our customers need. In application centers in Europe, Asia and North America, system solutions are tested and optimized in accordance with customer specifications. All this makes us a reliable supplier and development partner.

Comprehensive services complete our offering: SICK LifeTime Services provide support throughout the machine life cycle and ensure safety and productivity.

For us, that is “Sensor Intelligence.”

WORLDWIDE PRESENCE:

Contacts and other locations –www.sick.com