



Product designation	Power contactor		
Product type designation	BF26		
Contact characteristics			
Number of poles	Nr.	4	
Rated insulation voltage U _i IEC/EN	V	690	
Rated impulse withstand voltage U _{imp}	kV	6	
Operational frequency	min	Hz	25
	max	Hz	400
IEC Conventional free air thermal current I _{th}	A	45	
Operational current I _e	AC-1 (≤40°C)	A	45
	AC-1 (≤55°C)	A	36
	AC-1 (≤70°C)	A	32
	AC-3 (≤440V ≤55°C)	A	26
	AC-4 (400V)	A	11.5
Rated operational power AC-1 (T≤40°C)	230V	kW	17
	400V	kW	30
	500V	kW	37
	690V	kW	51
Short-time allowable current for 10s (IEC/EN60947-1)	A	210	
Protection fuse	gG (IEC)	A	50
	aM (IEC)	A	32
Making capacity (RMS value)	A	260	
Breaking capacity at voltage	440V	A	208
	500V	A	184
	690V	A	168
Resistance per pole (average value)	mΩ	2	
Power dissipation per pole (average value)	I _{th}	W	4
	AC-3	W	1.4
Tightening torque for terminals	min	Nm	2.5
	max	Nm	3
	min	lbin	1.8
	max	lbin	2.2
Tightening torque for coil terminal	min	Nm	0.8
	max	Nm	1
	min	lbin	0.8
	max	lbin	0.74
Max number of wires simultaneously connectable	Nr.	2	

Conductor section			
AWG/Kcmil		max	6
Flexible w/o lug conductor section			
		min	mm ² 2.5
		max	mm ² 16
Flexible c/w lug conductor section			
		min	mm ² 1
		max	mm ² 10
Flexible with insulated spade lug conductor section			
		min	mm ² 1
		max	mm ² 10
Power terminal protection according to IEC/EN 60529			IP20 when properly wired
Mechanical features			
Operating position			
		normal allowable	Vertical plan ±30°
Fixing			Screw / DIN rail 35mm
Weight			g 660
Conductor section			
AWG/kcmil conductor section		max	6
Operations			
Mechanical life		cycles	20000000
Electrical life		cycles	1600000
Safety related data			
Performance level B10d according to EN/ISO 13489-1			
		rated load	cycles 1600000
		mechanical load	cycles 20000000
Mirror contacts according to IEC/EN 60947-4-1			YES
EMC compatibility			yes
DC coil operating			
DC rated control voltage		V	24
DC operating voltage			
pick-up		min	%Us 80
		max	%Us 125
drop-out		min	%Us 10
		max	%Us 40
Average coil consumption ≤20°C			
		in-rush	W 5.4
		holding	W 5.4
Max cycles frequency			
Mechanical operation		cycles/h	3600
Operating times			
Average time for Us control			
in AC		Closing NO	
		min	ms 8
		max	ms 24

	Opening NO	min	ms	5
		max	ms	15
	Closing NC	min	ms	9
		max	ms	20
	Opening NC	min	ms	9
		max	ms	17
<hr/>				
in DC	Closing NO	min	ms	54
		max	ms	66
	Opening NO	min	ms	14
		max	ms	17
	Closing NC	min	ms	23
		max	ms	28
	Opening NC	min	ms	46
		max	ms	56

UL technical data

Full-load current (FLA) for three-phase AC motor

at 480V	A	21
at 600V	A	22

Yielded mechanical performance

for single-phase AC motor

110/120V	HP	2
230V	HP	5

for three-phase AC motor

200/208V	HP	7.5
220/230V	HP	7.5
460/480V	HP	15
575/600V	HP	20

General USE

Contactor

AC current	A	45
------------	---	----

Ambient conditions

Temperature

Operating temperature

min	°C	-50
max	°C	70

Storage temperature

min	°C	-60
max	°C	80

Max altitude

m	3000
---	------

Resistance & Protection

Pollution degree

3

Dimensions

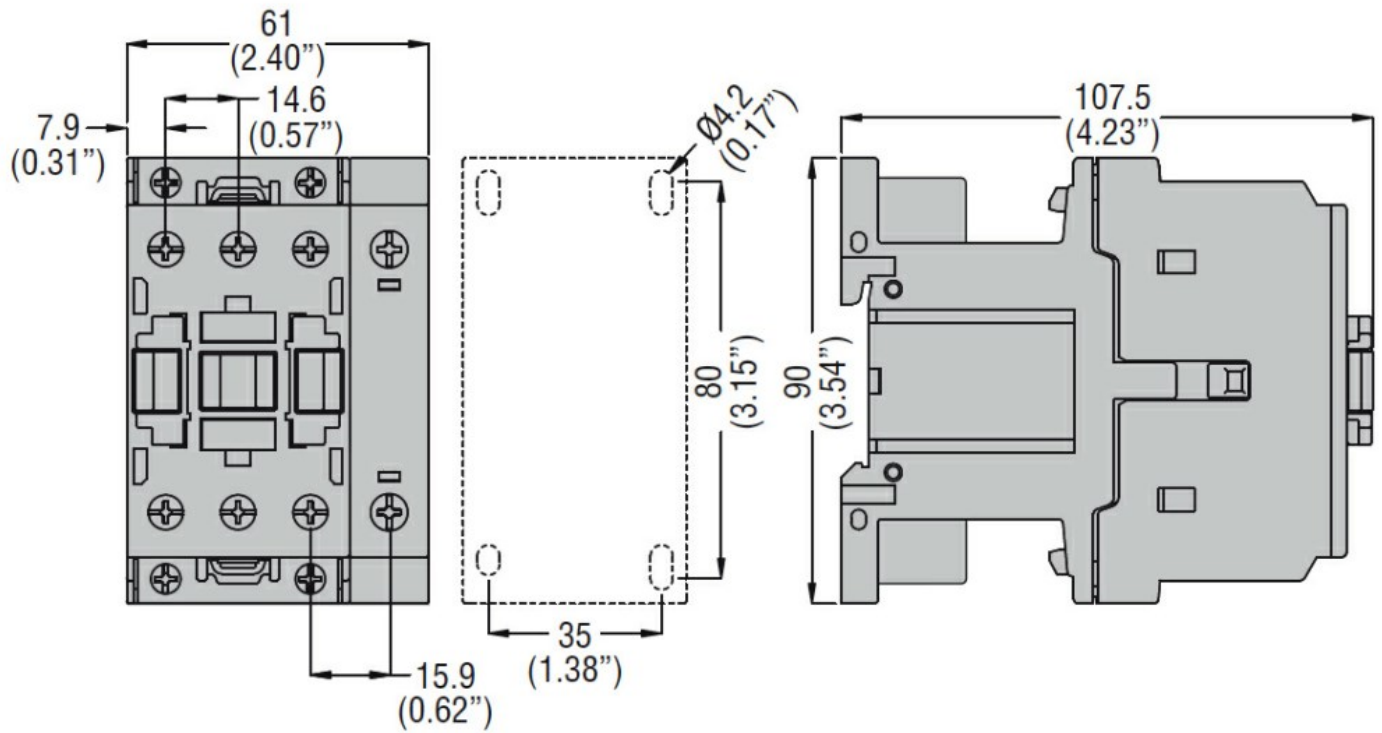

Wiring diagrams

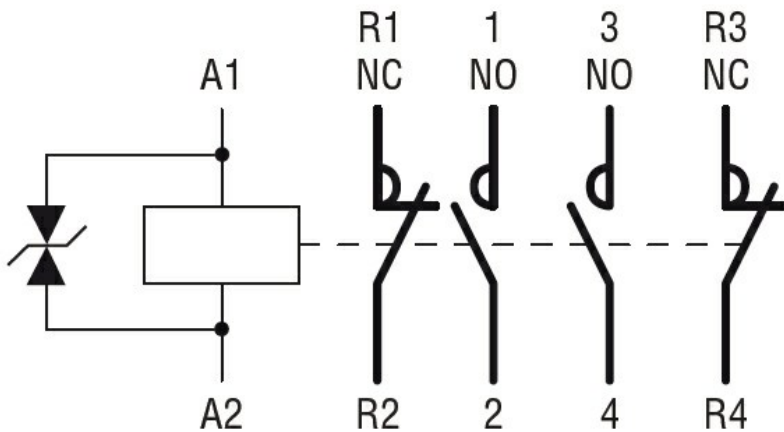

Certifications and compliance

Compliance

CSA C22.2 n° 60947-1

CSA C22.2 n° 60947-4-1

IEC/EN/BS 60947-1

IEC/EN/BS 60947-4-1

UL 60947-1

UL 60947-4-1

Certificates

CCC

cULus

EAC

ETIM classification

ETIM 8.0

EC000066 -
Power contactor,
AC switching