



DBS60I-BEFM02048

DBS60

INCREMENTAL ENCODERS

SICK
Sensor Intelligence.



Illustration may differ



Ordering information

Type	Part no.
DBS60I-BEFM02048	1089718

Other models and accessories → www.sick.com/DBS60

Detailed technical data

Performance

Pulses per revolution	2,048
Measuring step	90°, electric/pulses per revolution
Measuring step deviation	± 18° / pulses per revolution
Error limits	Measuring step deviation x 3
Duty cycle	≤ 0.5 ± 5 %

Interfaces

Communication interface	Incremental
Communication Interface detail	TTL / HTL ¹⁾
Number of signal channels	6-channel
Initialization time	< 5 ms ²⁾
Output frequency	≤ 300 kHz ³⁾
Load current	≤ 30 mA, per channel
Power consumption	≤ 0.5 W (without load)

¹⁾ Output level depends on the supply voltage.

²⁾ Valid signals can be read once this time has elapsed.

³⁾ Up to 450 kHz on request.

Electrical data

Connection type	Cable, 8-wire, radial, 5 m
Supply voltage	4.5 ... 30 V
Reference signal, number	1
Reference signal, position	90°, electric, logically gated with A and B
Reverse polarity protection	✓

¹⁾ Short-circuit opposite to another channel, US or GND permissible for maximum 30 s.

²⁾ This product is a standard product and does not constitute a safety component as defined in the Machinery Directive. Calculation based on nominal load of components, average ambient temperature 40°C, frequency of use 8760 h/a. All electronic failures are considered hazardous. For more information, see document no. 8015532.

Short-circuit protection of the outputs	✓ ¹⁾
MTTFd: mean time to dangerous failure	500 years (EN ISO 13849-1) ²⁾

¹⁾ Short-circuit opposite to another channel, US or GND permissible for maximum 30 s.

²⁾ This product is a standard product and does not constitute a safety component as defined in the Machinery Directive. Calculation based on nominal load of components, average ambient temperature 40 °C, frequency of use 8760 h/a. All electronic failures are considered hazardous. For more information, see document no. 8015532.

Mechanical data

Mechanical design	Blind hollow shaft
Shaft diameter	12 mm
Flange type / stator coupling	2-sided stator coupling, slot, screw hole circle 63–83 mm
Weight	0.44 kg ¹⁾
Shaft material	Stainless steel V2A
Flange material	Stainless steel V2A
Housing material	Stainless steel V2A
Material, cable	PVC
Shaft sealing ring material	FKM80
Material, cable gland	Stainless steel V2A / Nickel-plated brass
Start up torque	2.1 Ncm (+20 °C)
Operating torque	2 Ncm (+20 °C)
Permissible movement static	± 0.3 mm (radial) ± 0.5 mm (axial)
Permissible movement dynamic	± 0.1 mm ± 0.2 mm
Operating speed	≤ 6,000 min ⁻¹ ²⁾
Moment of inertia of the rotor	52 gcm ²
Bearing lifetime	3.6 x 10 ⁹ revolutions
Angular acceleration	≤ 500,000 rad/s ²

¹⁾ Based on encoder with male connector.

²⁾ Maximum speed which does not cause mechanical damage to the encoder. Impact on the service life and signal quality is possible. Please note the maximum output frequency.

Ambient data

EMC	According to EN 61000-6-2 and EN 61000-6-3
Enclosure rating	IP67, cable connection (IEC 60529)
Permissible relative humidity	90 % (Condensation not permitted)
Operating temperature range	-30 °C ... +100 °C, at maximum 3,000 pulses per revolution
Storage temperature range	-40 °C ... +100 °C, without package
Resistance to shocks	100 g, 6 ms (EN 60068-2-27)
Resistance to vibration	10 g, 10 Hz ... 2,000 Hz (EN 60068-2-6)

Classifications

eCl@ss 5.0	27270501
eCl@ss 5.1.4	27270501
eCl@ss 6.0	27270590

eCl@ss 6.2	27270590
eCl@ss 7.0	27270501
eCl@ss 8.0	27270501
eCl@ss 8.1	27270501
eCl@ss 9.0	27270501
eCl@ss 10.0	27270501
eCl@ss 11.0	27270501
eCl@ss 12.0	27270501
ETIM 5.0	EC001486
ETIM 6.0	EC001486
ETIM 7.0	EC001486
ETIM 8.0	EC001486
UNSPSC 16.0901	41112113

Dimensional drawing (Dimensions in mm (inch))

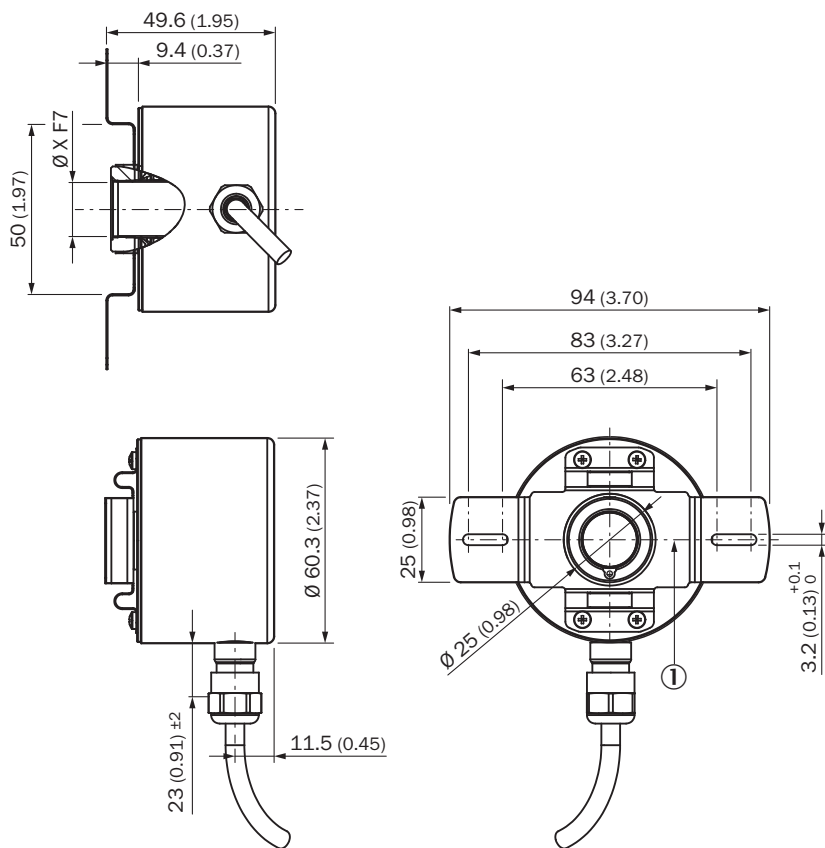

① Zero pulse mark on flange

Type	Shaft diameter XF7
Blind hollow shaft	
DBS60I-BAxxxxxxx	6 mm
DBS60I-BBxxxxxxx	8 mm

Type Blind hollow shaft	Shaft diameter XF7
DBS60I-BDxxxxxxx	10 mm
DBS60I-BExxxxxxx	12 mm
DBS60I-BGxxxxxxx	14 mm
DBS60I-BHxxxxxxx	15 mm

Attachment specifications

Blind hollow shaft

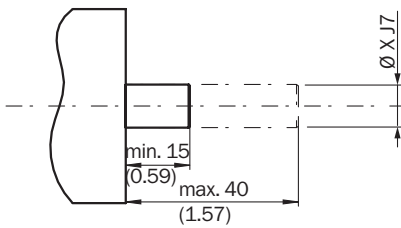

Customer side

Type Blind hollow shaft	Shaft diameter xj7
DBS60I-BAxxxxxxx	6 mm
DBS60I-BBxxxxxxx	8 mm
DBS60I-BDxxxxxxx	10 mm
DBS60I-BExxxxxxx	12 mm
DBS60I-BGxxxxxxx	14 mm
DBS60I-BHxxxxxxx	15 mm

PIN assignment

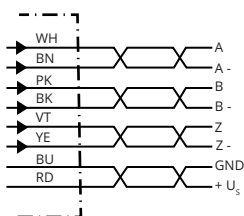

Wire colors (cable connection)	Male connector M12, 8-pin	TTL/HTL signal	Explanation
Brown	1	A-	Signal cable
White	2	A	Signal cable
Black	3	B-	Signal cable
Pink	4	B	Signal cable
Yellow	5	Z-	Signal cable
Purple	6	Z	Signal cable
Blue	7	GND	Ground connection

Wire colors (cable connection)	Male connector M12, 8-pin	TTL/HTL signal	Explanation
Red	8	+U _S	Supply voltage
Screen	Screen	Screen	Screen connected to housing on encoder side

Diagrams

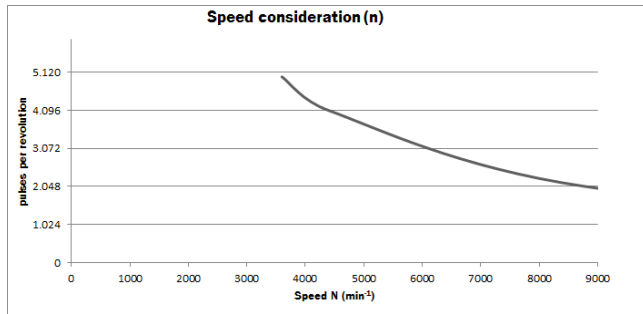

Signal outputs for electrical interfaces TTL and HTL

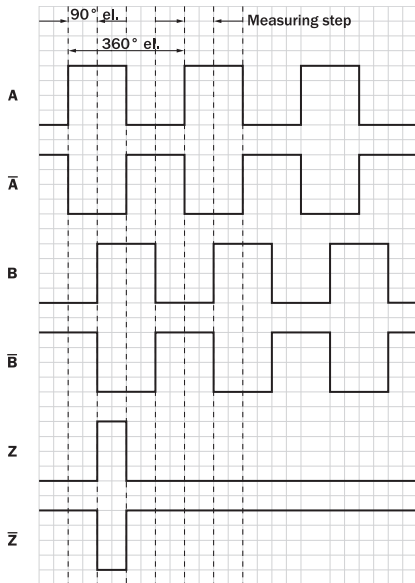

Cw with view on the encoder shaft in direction "A", compare dimensional drawing.

Supply voltage	Output
4,5 V ... 5,5 V	TTL
10 V ... 30 V	TTL
10 V ... 27 V	HTL
4,5 V ... 30 V	TTL/HTL universal
4,5 V ... 30 V	TTL

Operation note

Hollow shaft













Attention! If stator coupling is mounted, the zero pulse mark can be hidden by the stator coupling

- ① Zero pulse mark on flange
- ② Zero pulse is active when screw of clamping is inline with zero pulse mark on flange or housing mark

Recommended accessories

Other models and accessories → www.sick.com/DBS60

	Brief description	Type	Part no.
Flanges			
	Two-sided stator coupling, screw hole circle diameter 63 mm, slot width 3.2 mm	BEF-DS-09	2076214
	Two-sided stator coupling, slot, slot radius 63 mm – 83 mm, slot width 3.2 mm	BEF-DS-10	2076215
	One-sided stator coupling, slots, slot radius 32.75 mm – 142.65 mm, slot width 4.5 mm	BEF-DS-11	2076216
	Torque support, 1-sided, slotted hole, screw hole radius 31.5 mm - 48.5 mm, hole width 5.1 mm	BEF-DS-12	2076217
	One-sided stator coupling, slot, slot radius 32.1 mm – 37.6 mm, slot width 4.5 mm	BEF-DS-14	2076678
	Flange adapter, adaptation of face mount flange with 36 mm centering hub to 50 mm servo flange, stainless steel, including 3 countersunk screws with Precote 85-8 coating; M4*12	BEF-FA-036-050-I	2094778
Plug connectors and cables			
	Head A: cable Head B: Flying leads Cable: SSI, Incremental, HIPERFACE®, PUR, halogen-free, shielded	LTG-2308-MWENC	6027529
	Head A: cable Head B: Flying leads Cable: SSI, Incremental, PUR, shielded	LTG-2411-MW	6027530
	Head A: cable Head B: Flying leads Cable: SSI, TTL, HTL, Incremental, PUR, halogen-free, shielded	LTG-2612-MW	6028516

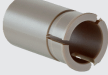
	Brief description	Type	Part no.
	Head A: male connector, M12, 8-pin, straight, A-coded Cable: shielded	YM12ES8-0050S5586A	2097337
Shaft adaptation			
	Collet metal for hollow shaft, shaft diameter 12 mm, outer diameter 5/8" (15.875 mm), metal	SPZ-58Z-012-M	2076221
	Collet plastic insulated for hollow shaft, shaft diameter 12 mm, outer diameter 5/8" (15.875 mm), plastic	SPZ-58Z-012-P	2076231

SICK AT A GLANCE

SICK is one of the leading manufacturers of intelligent sensors and sensor solutions for industrial applications. A unique range of products and services creates the perfect basis for controlling processes securely and efficiently, protecting individuals from accidents and preventing damage to the environment.

We have extensive experience in a wide range of industries and understand their processes and requirements. With intelligent sensors, we can deliver exactly what our customers need. In application centers in Europe, Asia and North America, system solutions are tested and optimized in accordance with customer specifications. All this makes us a reliable supplier and development partner.

Comprehensive services complete our offering: SICK LifeTime Services provide support throughout the machine life cycle and ensure safety and productivity.

For us, that is “Sensor Intelligence.”

WORLDWIDE PRESENCE:

Contacts and other locations –www.sick.com