

1SET131029R0000 ✓ ACTIVE

ENTRELEC

TE Internal #: 1SET131029R0000

Ring Terminals & Spade Terminals, Spade Tongue, 12 – 10 AWG

Wire Size, 2.62 – 6.64 mm<sup>2</sup> Wire Size, 5180 – 13100 CMA Wire Size,

Stud Size #6 / M3.5

[View on TE.com >](#)



Terminals & Splices > Ring Terminals & Spade Terminals

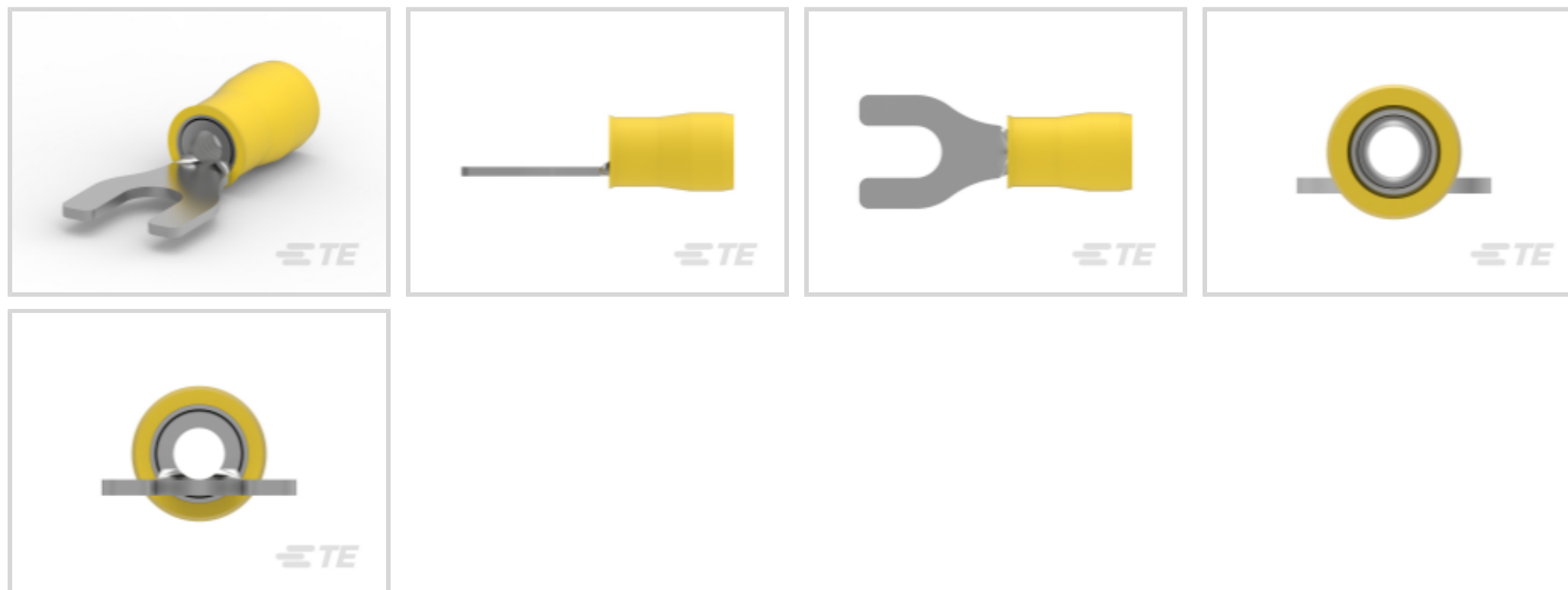

Ring & Spade Terminal Type: **Spade Tongue**

Wire Size: **5180 – 13100 CMA**

Stud Size: **#6, M3.5**

## Features

### Product Type Features

Shape Description	SPADE-020
Stud Size	#6, M3.5
Sealable	No
Wire Insulation Support Retention Type	Insulation Support

### Configuration Features

Terminal Angle	180 °
----------------	-------

### Electrical Characteristics

Voltage (Max)	300 V
---------------	-------

### Body Features

Inspection Slot	No
Weight per Piece	2.373 g

### Contact Features

Ring & Spade Terminal Type	Spade Tongue
Barrel Type	Closed
Terminal Orientation	Straight



Terminal Plating Material	Tin
---------------------------	-----

### Mechanical Attachment

Wire Insulation Support	With
-------------------------	------

### Dimensions

Wire Size	5180 – 13100 CMA
Stud Diameter	3.68 mm[.145 in]
Tongue Thickness	.79 mm[.031 in]
Overall Product Length	27.81 mm[1.095 in]
Accepts Wire Insulation Diameter (Max)	5.84 mm[.23 in]
Accepts Wire Insulation Diameter Range	3.81 – 5.84 mm[.15 – .23 in]

### Usage Conditions

Insulation Option	Partially Insulated
Operating Temperature Range	105 °C[221 °F]

### Operation/Application

Heavy Duty	No
------------	----

### Industry Standards

Government Qualified	No
----------------------	----

### Packaging Features

Packaging Quantity	500
Packaging Method	Loose Piece

### Product Compliance

[For compliance documentation, visit the product page on TE.com>](#)

EU RoHS Directive 2011/65/EU	Compliant
EU ELV Directive 2000/53/EC	Compliant
China RoHS 2 Directive MIIT Order No 32, 2016	No Restricted Materials Above Threshold
EU REACH Regulation (EC) No. 1907/2006	Current ECHA Candidate List: JUNE 2022 (224) Candidate List Declared Against: JUNE 2022 (224) Does not contain REACH SVHC
Halogen Content	Low Halogen - Br, Cl, F, I < 900 ppm per homogenous material. Also BFR/CFR/PVC Free

Solder Process Capability

Not applicable for solder process capability

Product Compliance Disclaimer

This information is provided based on reasonable inquiry of our suppliers and represents our current actual knowledge based on the information they provided. This information is subject to change. The part numbers that TE has identified as EU RoHS compliant have a maximum concentration of 0.1% by weight in homogenous materials for lead, hexavalent chromium, mercury, PBB, PBDE, DBP, BBP, DEHP, DIBP, and 0.01% for cadmium, or qualify for an exemption to these limits as defined in the Annexes of Directive 2011/65/EU (RoHS2). Finished electrical and electronic equipment products will be CE marked as required by Directive 2011/65/EU. Components may not be CE marked. Additionally, the part numbers that TE has identified as EU ELV compliant have a maximum concentration of 0.1% by weight in homogenous materials for lead, hexavalent chromium, and mercury, and 0.01% for cadmium, or qualify for an exemption to these limits as defined in the Annexes of Directive 2000/53/EC (ELV). Regarding the REACH Regulation, the information TE provides on SVHC in articles for this part number is based on the latest European Chemicals Agency (ECHA) 'Guidance on requirements for substances in articles' posted at this URL: <https://echa.europa.eu/guidance-documents/guidance-on-reach>

## Compatible Parts



TE Part # 59824-1  
TETRA-CRIMP PIDG PG FASTON 22-10 ASSY



TE Part # 58433-3  
PRO CR ASSY, RBY IS9252



TE Part # 59239-4  
HHHT PIDG PG 12-10 ASSY



TE Part # 58423-1  
DIE, RBY IS9252



TE Part # 539691-2  
ERGO DIE R.B.Y



TE Part # 2063030-1  
SDE DIESET, RBY, UL



TE Part # 47808-6  
DIES PIDG 12-10 DIE SET

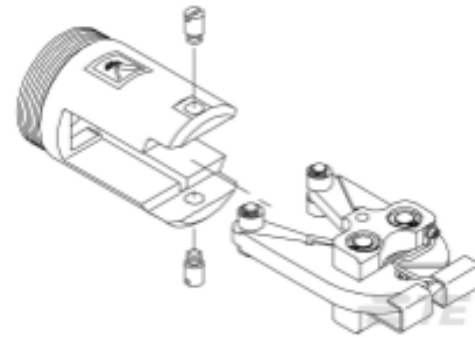

TE Part # 679300-1  
1210 PIDG CRIMP HEAD



TE Part # 169400  
CERTI-LOK FRAME W/O DIES



TE Part # 1-59239-4  
HHHT PIDG 16-10 HEAD



TE Part # 1SET191002R0000  
TET CRIMP-HT



TE Part # 169404  
CERTI-LOK DIE

## Customers Also Bought

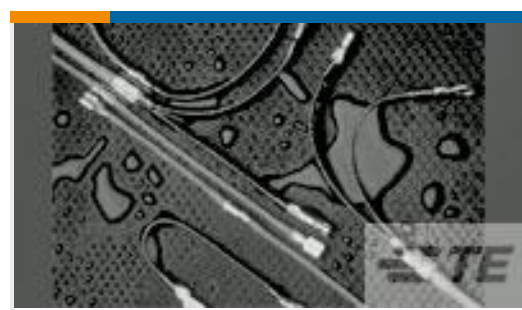

TE Part #CC2648-000  
B-106-1603CS50

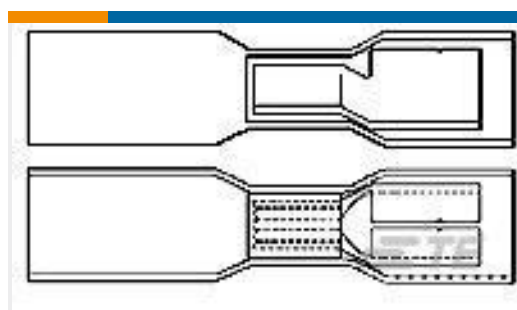

TE Part #CC2644-000  
B-106-8502CS100

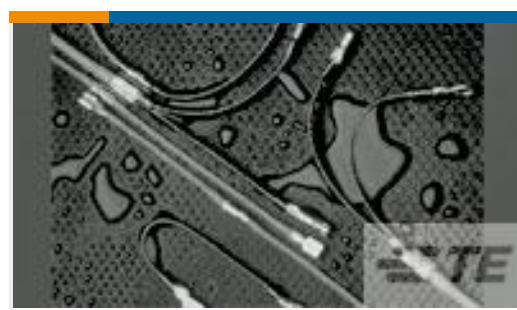

TE Part #CC2623-000  
B-106-1601CS100

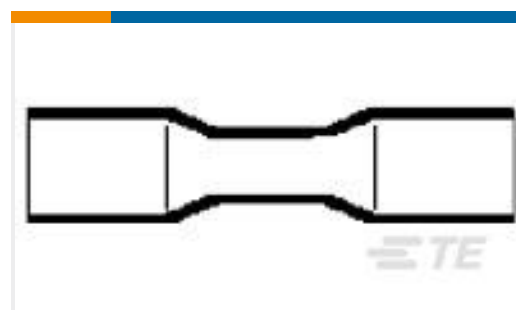

TE Part #CC2645-000  
D-406-0003CS50

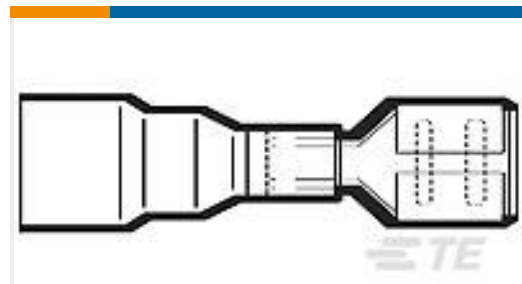

TE Part #CC2641-000  
B-106-3632CS100

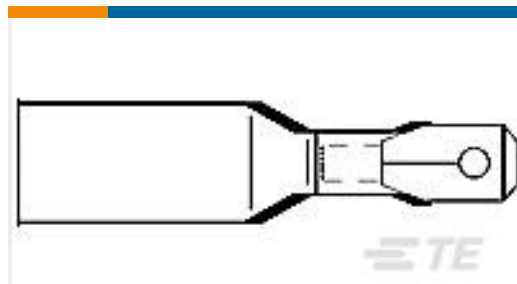

TE Part #CC2642-000  
B-106-4632CS100

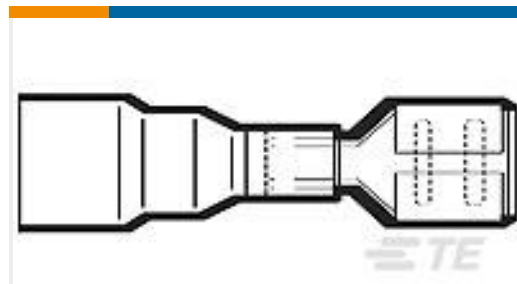

TE Part #CC2628-000  
B-106-3631CS100

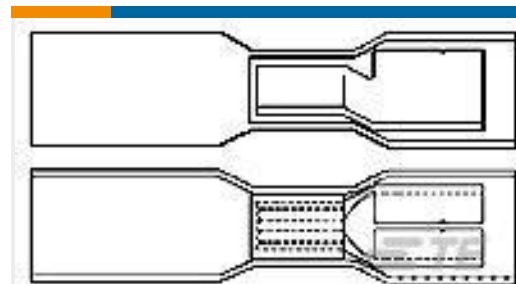

TE Part #CC2632-000  
B-106-8401CS100

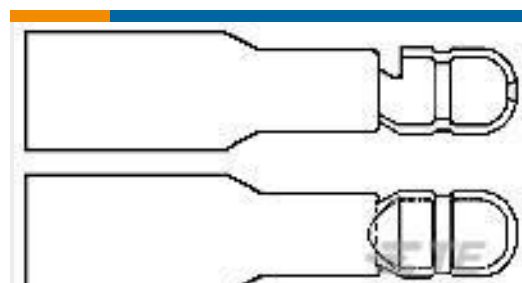

TE Part #CC2643-000  
B-106-7502CS100



TE Part #CC2637-000  
B-106-1802CS100

## Documents

### Product Drawings

[SD060-035-N](#)

English

### CAD Files

[3D PDF](#)

3D

Customer View Model

[ENG\\_CVM\\_CVM\\_1SET131029R0000\\_A.2d\\_dxf.zip](#)

English

Customer View Model

[ENG\\_CVM\\_CVM\\_1SET131029R0000\\_A.3d\\_igs.zip](#)

English

Customer View Model

[ENG\\_CVM\\_CVM\\_1SET131029R0000\\_A.3d\\_stp.zip](#)

English

By downloading the CAD file I accept and agree to the [Terms and Conditions](#) of use.

### Datasheets & Catalog Pages



[Infographic - entrelec ews-linecard](#)

English

[PIDG TERMINALS & SPLICES Quick Reference Guide](#)

English

[Essential Entrelec Terminal Blocks](#)

French

[Essential Entrelec Terminal Blocks](#)

English

---

[Product Specifications](#)

[Application Specification](#)

English